

# **SURGICAL**

## **INSTRUMENTS**

*High Quality  
Instruments*

Diagnostic  
Laryngoscope  
Scissors  
Dissec  
Hamostats Forceps  
Needle Holders  
Retractors  
Cordio Vascular  
Electro Surgical  
Hollow Ware



**ALSAIF**  
Traders

**Manufacturer & Exporters of Surgical Instruments**

📍 Dulchikey, Ugoki Wazirabad Road, Sialkot-Pakistan

Email: [alsai traders7@gmail.com](mailto:alsai traders7@gmail.com)

E-mail: [info@alsai traders.com](mailto:info@alsai traders.com)

Web: [www.alsai traders.com](http://www.alsai traders.com)

📞 +92-300-6104824

📞 +92-52-3570286

*We present this CATALOGUE with a hope that it would be an excellent guide to all over promoters and Surgical professionals the world over.*

*We endeavor to present in this CATALOGUE a modern range of instruments to the trade and medical professionals in order to achieve the highest result.*

*We are the located in the center of the city which is known the world over for this profession having at our disposal expert crafted whose skilled technique and traditional approach towards modern surgery makes all the possibilities to acclaim us quality instruments producers.*

*We are grateful for the loyal support given to us by our promoters who have been selling our Stainless Steel Surgical Instruments in their market with pride and honor.*

*We pledge to serve more in the years ahead to our quality minded promoters with much more higher standard and correct design of the instruments.*

*We also welcome our enquiries for the instruments not listed in This CATALOGUE both in Surgical instruments.*

*It is our earnest desire to maintain our present price but due to the present universal economic condition which are beyond our control, all prices are subjected to change without any notice.*



**DIAGNOSTIC SET  
(ENT COMPLETE)  
101-0001**

Consisting of Battery Handle (without Battery)  
3 Ear Specula, 1 Nasel Specula,  
2 Laryngeal mirrors with Holder  
1 Tongue Depressor Holder, 1 Bulb



**OTOSCOPE Set  
101-0002**

Consisting of Battery Handle  
(without Battery) 3 Ear Specula, 1 Bulb

● ● ● Diagnostic

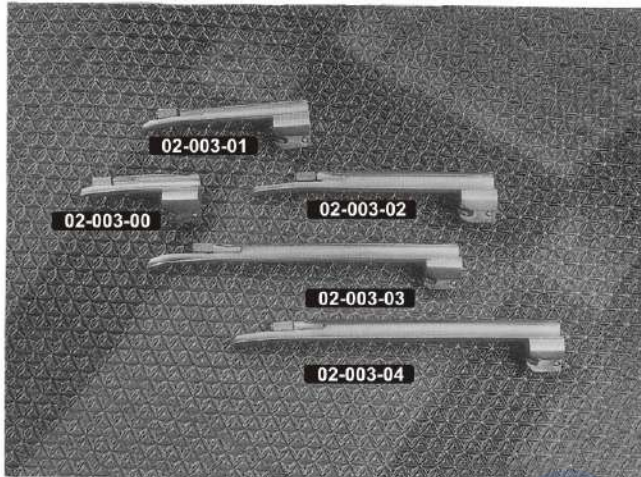

Miller



Miller  
101-0003  
Laryngoscope  
set



**DIAGNOSTIC SET  
(ENT COMPLETE)  
101-0001**

Consisting of Battery Handle (without Battery)  
3 Ear Specula, 1 Nasel Specula,  
2 Laryngeal mirrors with Holder  
1 Tongue Depressor Holder, 1 Bulb



**OTOSCOPE Set  
101-0002**

Consisting of Battery Handle  
(without Battery) 3 Ear Specula, 1 Bulb

## ●●● Surgical Handles



No.3L  
102-0001

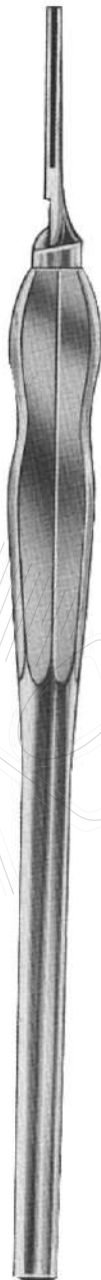

ERGONOMIC  
102-0002



No.7  
102-0003

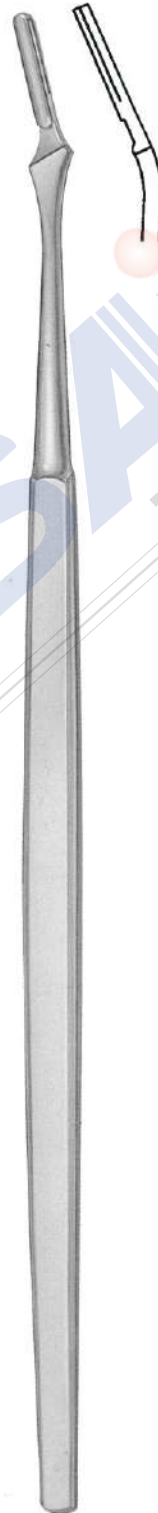

102-0004



102-0005



102-0006



**No.4L**  
102-0007

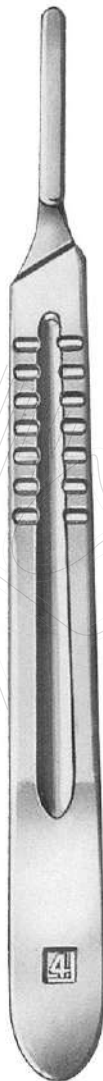

**No.4**  
102-0008

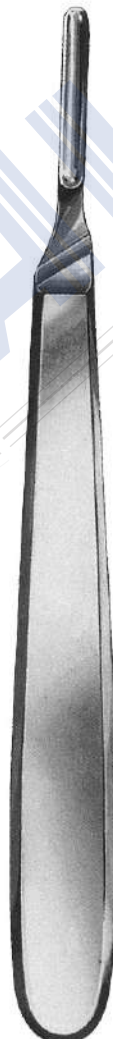

**No.10**  
102-0009



**No.9**  
102-0010



**No. 3**  
102-0011



**BARRON**  
102-0012  
For "B.P." type blades  
for use with No's  
10,11,12 & 15 blades  
135mm (5.1/4")

● ● ● Scissors

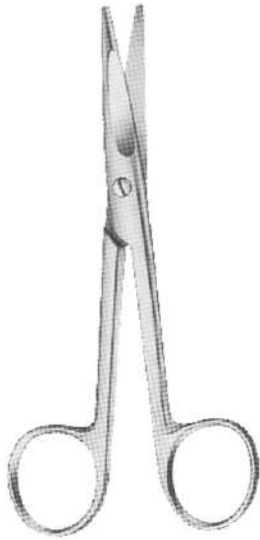

**MAYO**  
Straight, bevelled blades



**103-0001**  
140 mm  
(5.1/2")

**103-0003**  
190 mm  
(7.1/2")



**103-0002**  
170 mm  
(6.3/4")

**103-0004**  
215mm  
(8.1/2")



**103-0005**  
140 mm  
(5.1/2")

**103-0007**  
190 mm  
(7.1/2")

**103-0006**  
170 mm  
(6.3/4")

**103-0008**  
215mm  
(8.1/2")

Curved on flat, bevelled blades

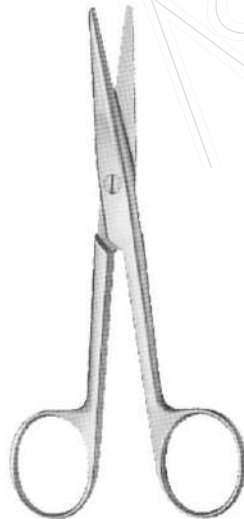

**MAYO**  
Round Blades

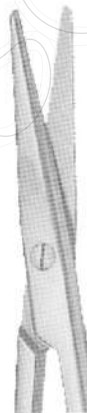

**103-0009**  
170 mm  
(6.3/4")

200mm  
(8")  
Straight



**103-0010**  
140mm  
(5.1/2")

150 mm  
(6")  
Straight



**MAYO**  
Round Blades



**103-0011**  
170 mm  
(6.3/4")

200mm  
(8")  
Curved on flat



**103-0012**  
140mm  
(5.1/2")

150 mm  
(6")  
Curved on flat



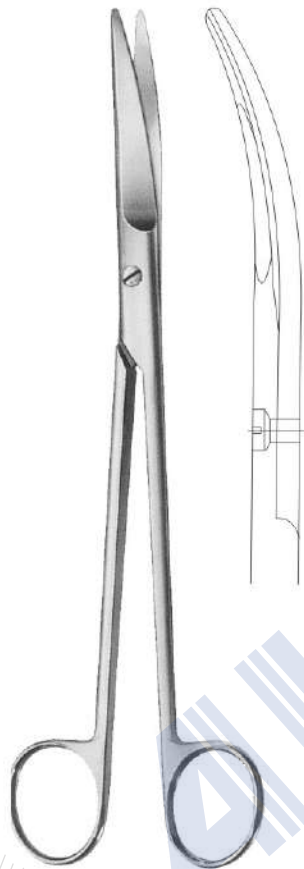

**MAYO HARRINGTON**  
**103-0013**  
 225mm (9")  
 Curved on flat , blunt points

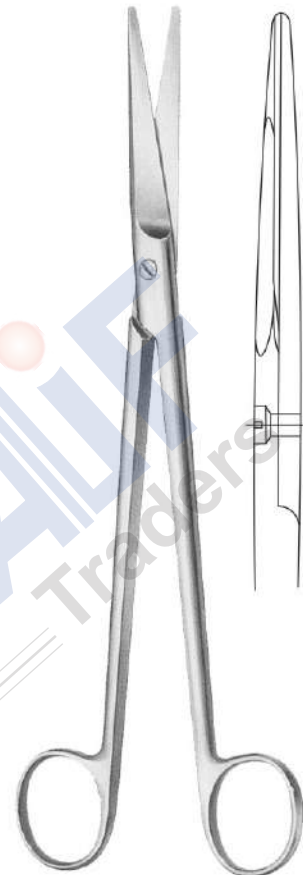

**MAYO HARRINGTON**  
**103-0014**  
 225mm (9")  
 Straight, blunt points



**MAYO (STILLE)**



**103-0015**  
 170 mm  
 (6.3/4")  
 Straight



**103-0016**  
 150 mm  
 (6")  
 Straight



**103-0017**  
 170 mm  
 (6.3/4")  
 Curved on  
 flate



**103-0018**  
 150 mm  
 (6")  
 Curved on  
 flate



● ● ● Scissors



**METZENBAUM**

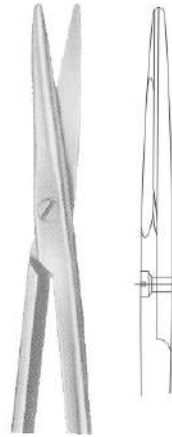

**METZENBAUM**  
Straight, blunt points  
103-0019 115mm (4.1/2")  
103-0020 145mm (5.3/4")  
103-0021 180mm (7")  
103-0022 200mm (8")

**METZENBAUM (Nelson)**  
Straight  
103-0023 230mm (9")  
103-0024 250mm (10")

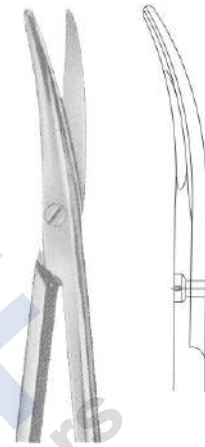

**METZENBAUM**  
Curved on flat, blunt points  
103-0025 115mm (4.1/2")  
103-0026 145mm (5.3/4")  
103-0027 180mm (7")  
103-0028 200mm (8")

**METZENBAUM (Nelson)**  
Curved on flat  
103-0029 230mm (9")  
103-0030 250mm (10")

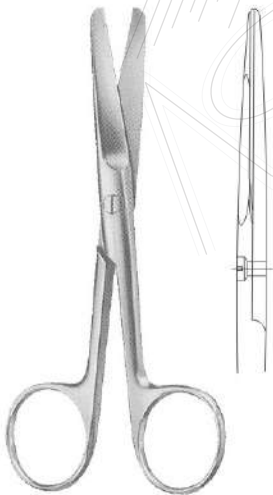

**DRESSING**  
Straight, blunt / blunt points  
103-0031 125mm (5")  
103-0032 145mm (5.3/4")  
103-0033 150mm (6")  
103-0034 180mm (7")  
103-0035 200mm (8")

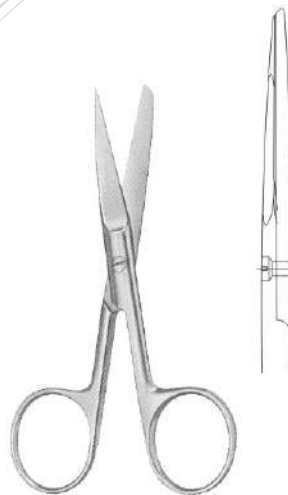

**DRESSING**  
Straight, sharp / blunt points  
103-0036 125mm (5")  
103-0037 145mm (5.3/4")  
103-0038 150mm (6")  
103-0039 180mm (7")  
103-0040 200mm (8")

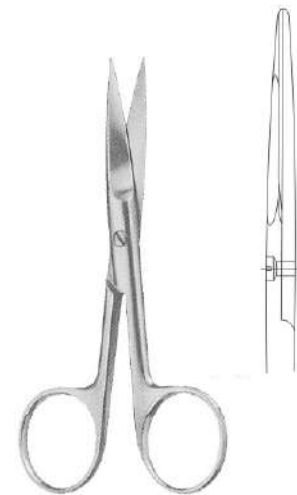

**DRESSING**  
Straight, sharp / Sharp points  
103-0041 125mm (5")  
103-0042 145mm (5.3/4")  
103-0043 150mm (6")  
103-0044 180mm (7")  
103-0045 200mm (8")



**CRAFOORD**  
**103-0046** 305mm (12")  
 Straight

**LLOYD DAVIS RECTAL**  
 blunt points, flat blades  
**103-0047** 255mm (10")  
 Curved on flat  
**103-0048** 255mm (10")  
 Straight

**UTERINE**  
**103-0049** 230mm (9")  
 Straight, blunt points

**UTERINE**  
 Curved on flat, blunt points  
**103-0050** 200mm (8")  
**103-0051** 230mm (9")

● ● ● Scissors



**BRAUN STADTLER**  
**EPISIOTOMY** Angled blades  
 103-0052 145mm (5.3/4")  
 103-0053 200mm (8")



**AMERICAN PATTERN**  
**UMBILICAL** Angled blades  
 103-0054 100mm (4")

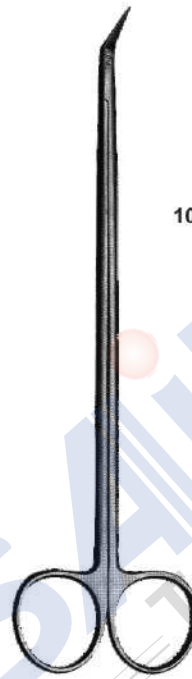

**HEGEMANN'S DELICATE**  
 190mm (7.1/2")

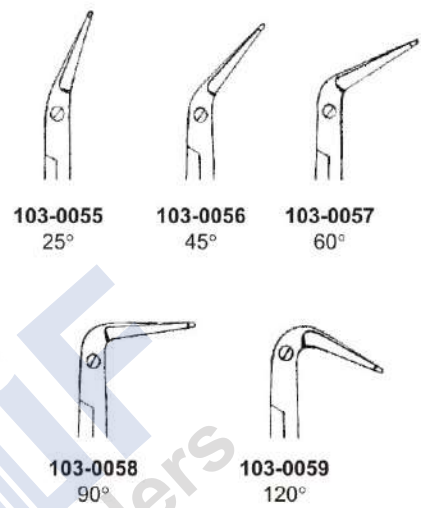

103-0055  
25°

103-0056  
45°

103-0057  
60°

103-0058  
90°

103-0059  
120°



**KILNER**  
 103-0060 110mm (4.1/2")  
 Straight, sharp points  
 103-0061 110mm (4.1/2")  
 Curved on flat, blunt points

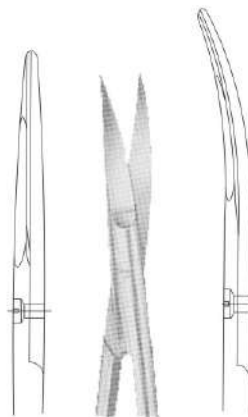
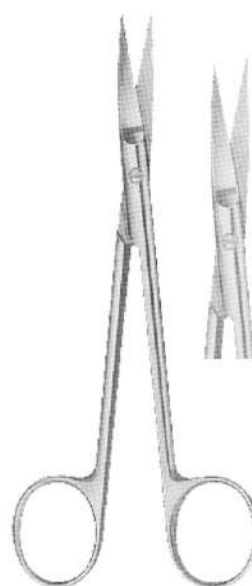
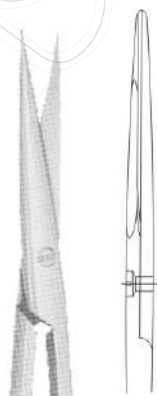

**AUFRICHT**  
 150mm (6") Lightweight  
 103-0062 Straight  
 103-0063 Curved on flat

## Delicate Scissors ●●●



**103-0064**  
Straight  
**103-0065**  
Curved on flat

**IRIS**  
110mm (4.1/2")  
sharp points



**103-0066**  
Straight  
**103-0067**  
Curved on flat

**IRIS**  
110mm (4.1/2")  
Round blades,  
sharp points

**IRIS**  
**103-0068** 90mm (3.1/2")  
Curved on flat, lightweight  
sharp points

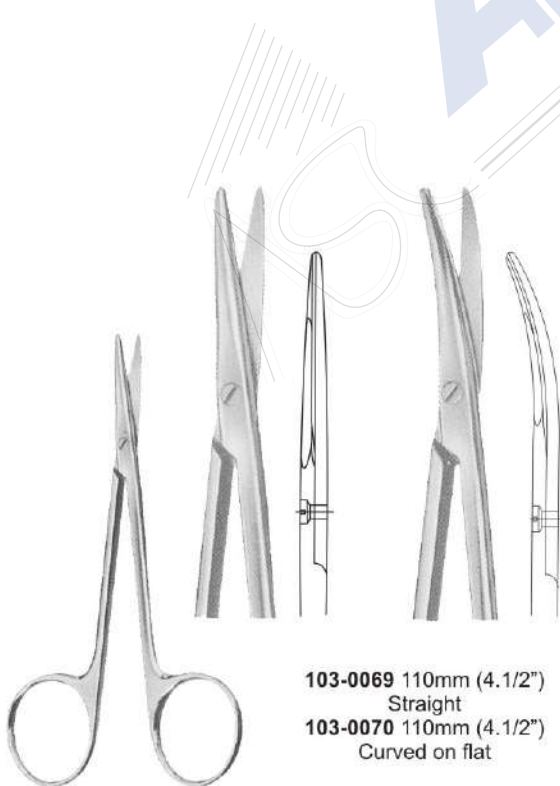

**103-0069** 110mm (4.1/2")  
Straight  
**103-0070** 110mm (4.1/2")  
Curved on flat

**STRABISMUS**



**HEYMANN**  
**TURBINECTOMY**  
**103-0071** 185mm (7.1/4")  
Angled shanks  
blunt points

●●● Delicate & Oral Scissors



**STEVENS TENOTOMY**  
110 mm (4.1/4")

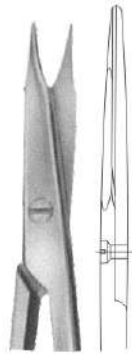

**103-0072**  
straight,  
sharp points

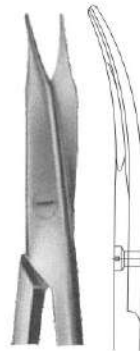

**103-0073**  
Curved on flat  
sharp points

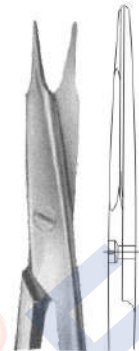

**103-0074**  
straight,  
blunt points



**103-0075**  
Curved on flat  
blunt points

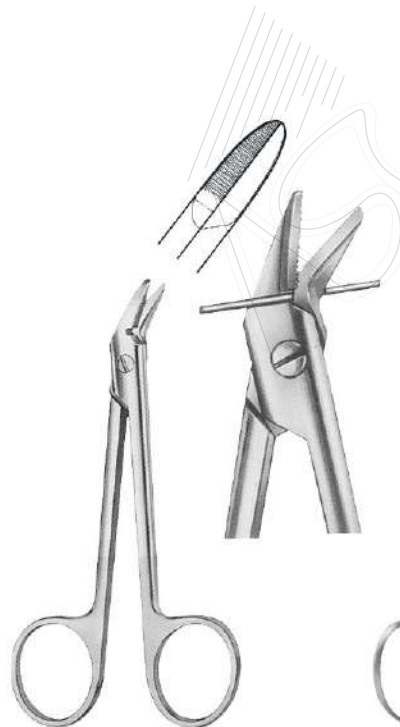

**SCHUKNECHT  
WIRE CUTTING**  
103-0076 125mm (5")



**WOODS TONSIL**  
190mm (7.1/2")



**103-0077**  
Curved on flat  
sharpened  
outer edge, blunt



**WHEELER TONSIL**  
103-0078 200mm (8")  
Curved on flat

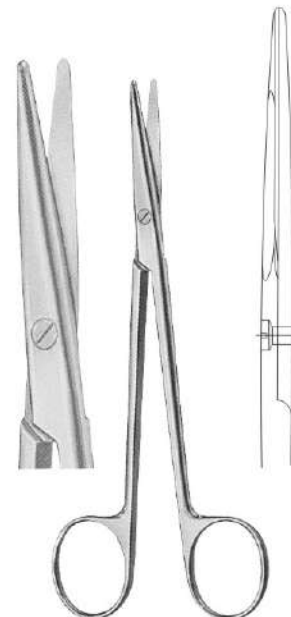

**WILSON TONSIL**  
103-0079 180mm (7")  
Straight

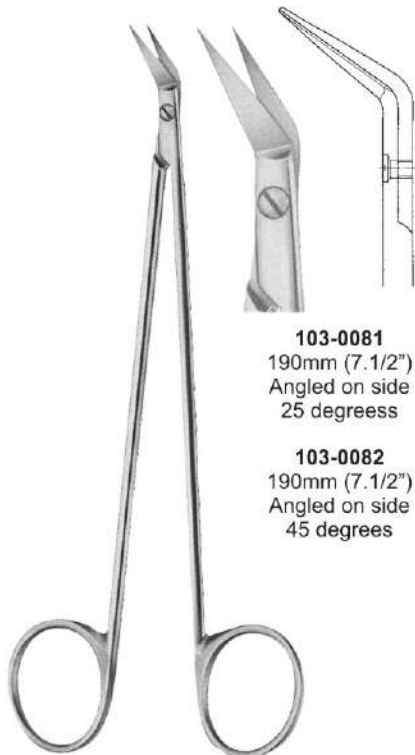

**103-0081**  
190mm (7.1/2")  
Angled on side  
25 degrees

**103-0082**  
190mm (7.1/2")  
Angled on side  
45 degrees

**POTTS**  
**103-0080** 190mm (7.1/2")  
Angled on flat 45 degrees

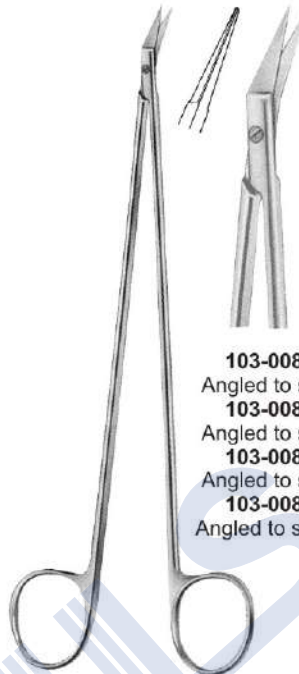

**103-0084** 175mm (7")  
Angled to side, 45 degrees  
**103-0085** 175mm (7")  
Angled to side, 60 degrees  
**103-0086** 175mm (7")  
Angled to side, 90 degrees  
**103-0087** 175mm (7")  
Angled to side, 125 degrees

**HEDGEMAN (DIETRICH)**  
**103-0083** 175mm (7")  
Angled to side, 25 degrees

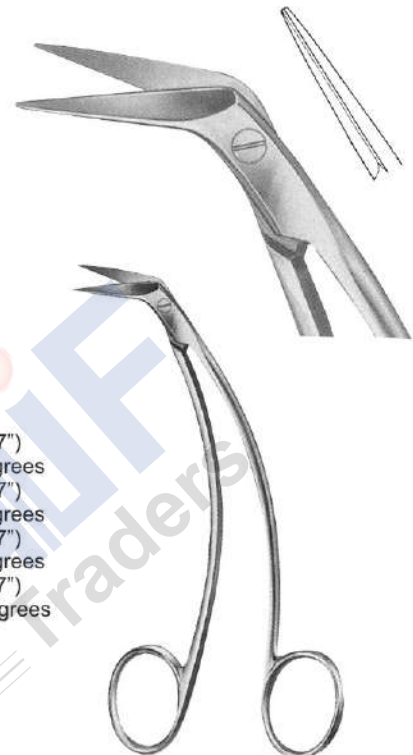

**FAVALORO**  
**103-0088** 150mm (6")  
Shanks curved, blades angled to side

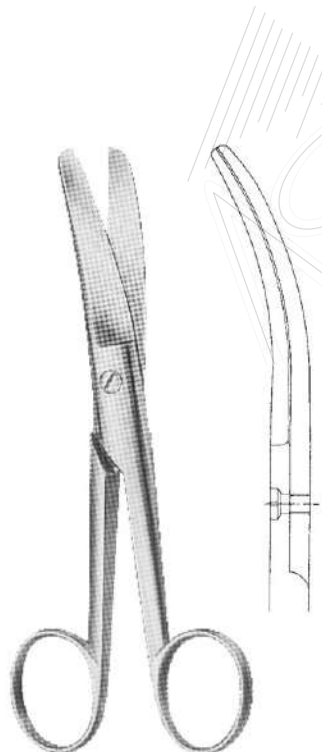

**DOYEN ABDOMINAL**  
**103-0089** 180mm (7")  
Curved, blunt points

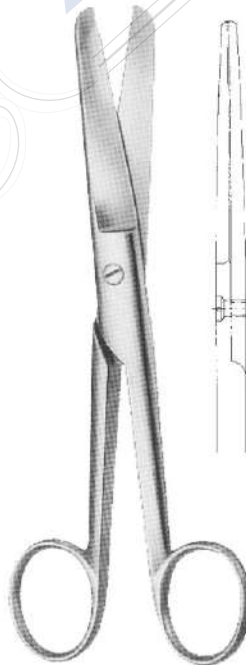

**DOYEN ABDOMINAL**  
**103-0090** 180mm (7")  
Straight, blunt points

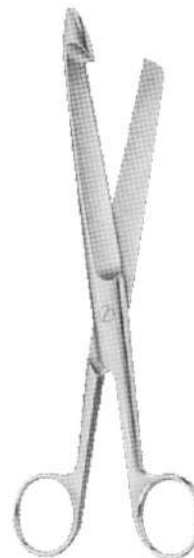

**DOYEN ABDOMINAL**  
**103-0091** 210mm (8.1/4")  
One blade with hook end



**COUNTER SCISSORS**  
**103-0092** 210mm (8.1/4")

● ● ● Scissors

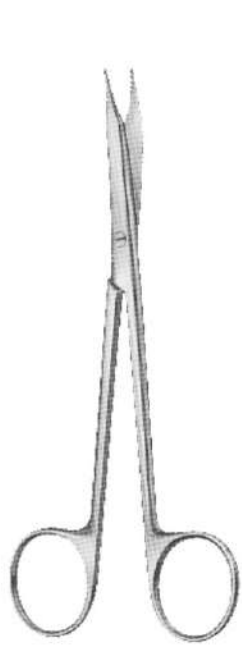

**REYNOLDS**  
Curved on flat, tapered points

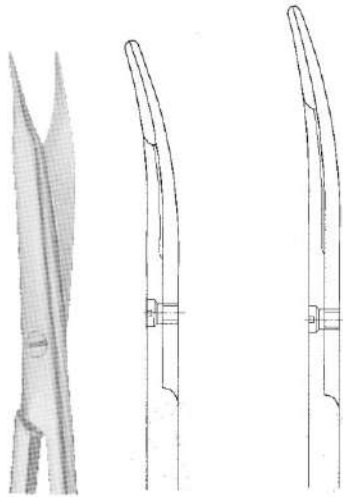

103-0093 145mm (5.3/4")  
103-0094 180mm (7")

103-0095 115mm (4.1/2")  
103-0096 140mm (5.1/2")  
103-0097 180mm (7")  
103-0098 200mm (8")  
103-0099 235mm (9.1/4")

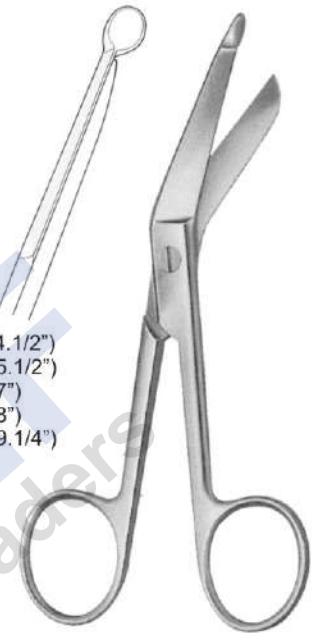

**LISTER BANDAGEz**



**SCHUMACHER UMBILICAL**  
103-0100 155mm (6")

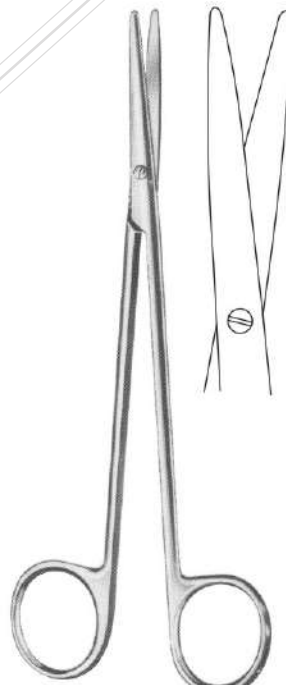

**MCINDOE SCISSORS**  
103-0101 180mm (7")  
Straight

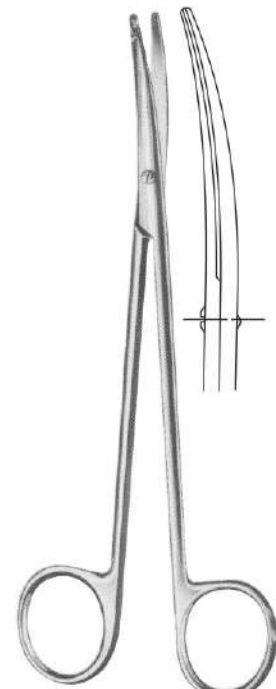

**MCINDOE SCISSORS**  
103-0102 180mm (7")  
Curved



## Serrated Dissecting Forceps ●●●



**CANADIAN**  
Straight  
104-0001 130mm (5.1/8")  
104-0002 150mm (6")



**DISSECTING FORCEPS**  
Turn over end  
104-0003 125mm (5")  
104-0004 150mm (6")  
104-0005 180mm (7")  
104-0006 200mm (8")  
104-0007 250mm (10")



**DISSECTING FORCEPS**  
Block end  
104-0008 125mm (5")  
104-0009 150mm (6")  
104-0010 180mm (7")  
104-0011 200mm (8")  
104-0012 250mm (10")



**DISSECTING FORCEPS**



104-0013  
150mm (6")



104-0014  
180mm (7")



104-0015  
200mm (8")

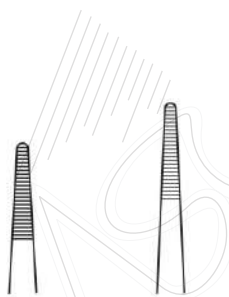

104-0016  
115mm (4.1/2")

104-0017  
130mm (5.1/8")



104-0021  
115mm (4.1/2")



104-0022  
130mm (5.1/8")



104-0023  
150mm (6")



104-0024  
160mm (6.1/4")



**DISSECTING FORCEPS**



104-0018  
145mm (5.3/4")



104-0019  
160mm (6.1/4")



104-0020  
305mm (12")



**DISSECTING FORCEPS**  
Round Points



104-0025  
180mm (7")



104-0026  
200mm (8")



104-0027  
250mm (10")



104-0028  
300mm (12")

## ●●● Serrated Dissecting Forceps



**RAMSEY**  
104-0029  
180mm (7")

**BONNEY**  
104-0030  
180mm (7")

**BICKFORD**  
104-0031  
225mm (9")

**MAINGOT INTESTINAL**  
Fenestrated Grip  
104-0032  
280mm (11")

**ST MARKS**  
104-0033  
290mm (11.1/2")

**EMMET**  
104-0034  
200mm (8")

## Delicate Dissecting Forceps ●●●

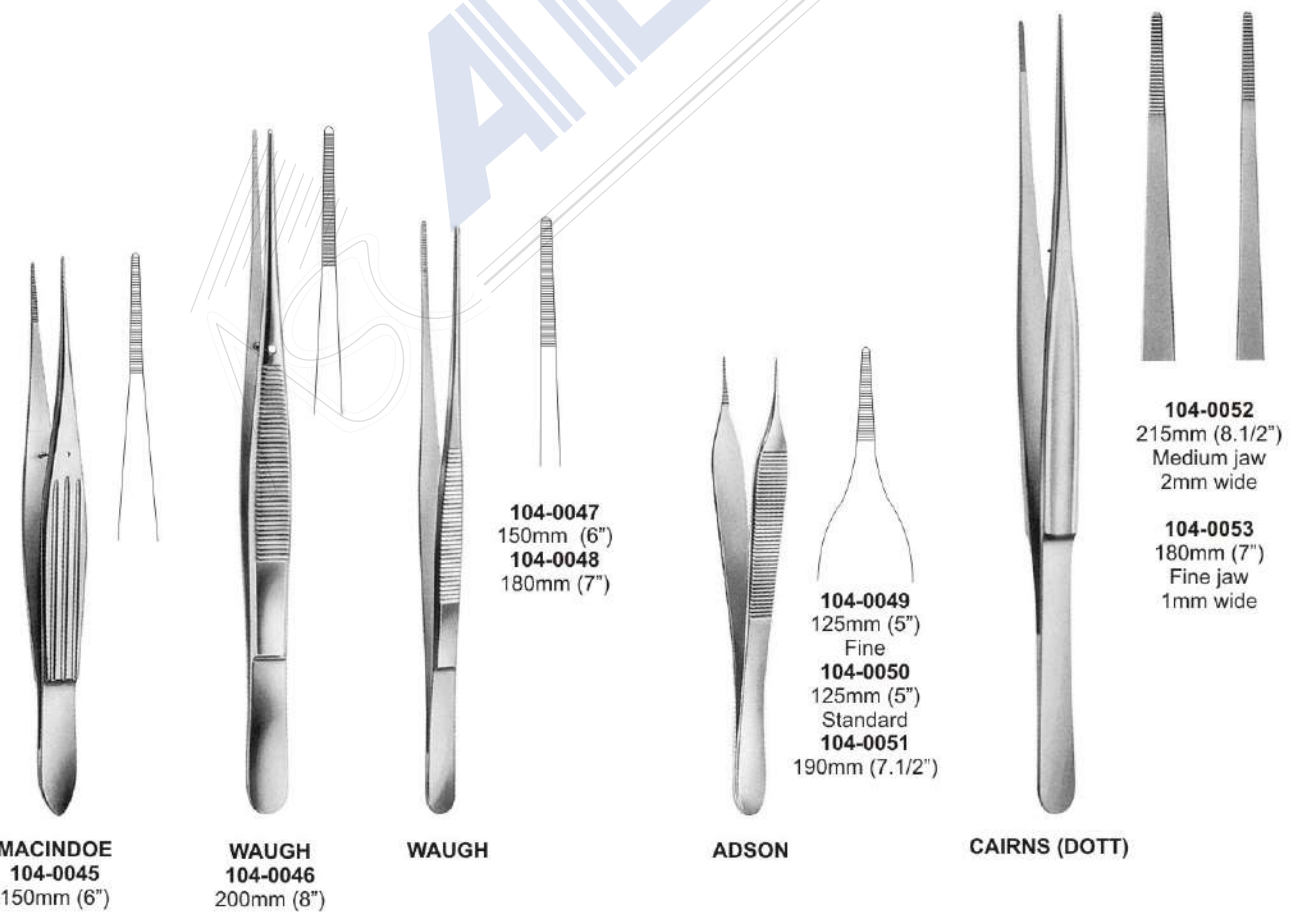
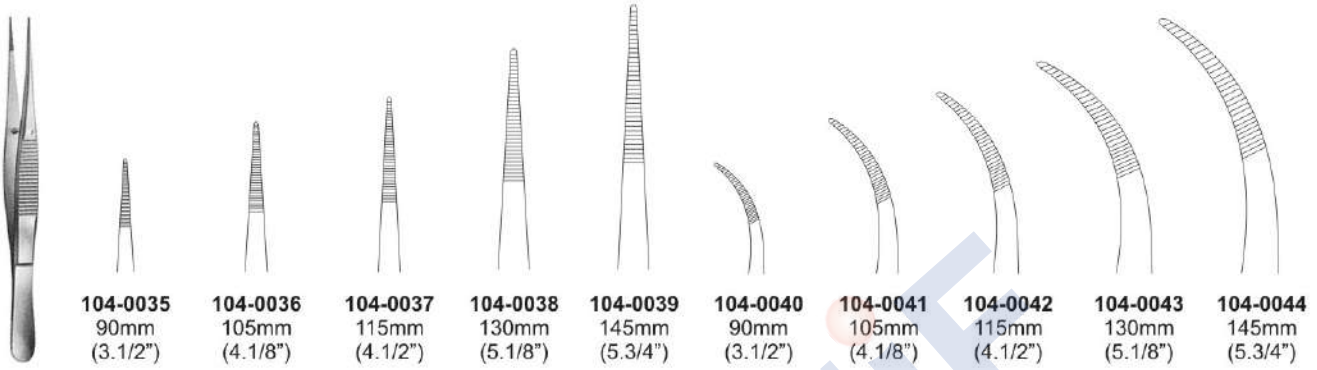

## ●●● Delicate Dissecting Forceps

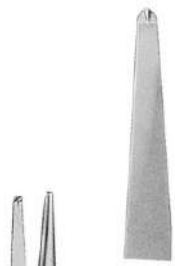

**104-0054**  
125mm (5")  
**104-0055**  
150mm (6")  
**104-0056**  
180mm (7")  
**104-0057**  
200mm (8")  
**104-0058**  
250mm (10")

**TREVES**  
1 x 2 teeth



**104-0059**  
125 mm (5")  
**104-0060**  
145mm (5.3/4")  
**104-0061**  
180mm (7")  
**LANE**  
2 x 3 teeth  
**104-0062**  
145mm (5.3/4")  
**104-0063**  
180mm (7")

**LANE**  
1 x 2 teeth



**DISSECTING FORCEPS**

**104-0064**  
150mm (6")  
2 x 3 teeth  
**104-0065**  
150mm (6")  
3 x 4 teeth



**WAUGH**  
1 x 2 teeth



**104-0066**  
200mm (8")  
**104-0067**  
180mm (7")  
**104-0068**  
150mm (6")



**ADSON**  
1 X 2 teeth



**104-0069**  
125mm (5") Fine  
**104-0070**  
125mm (5") Standard  
**104-0071**  
190mm (7.1/2")



**ADSON**  
Bayonet  
1 x 2 teeth

**104-0072**  
190mm (7.1/2")



**JEFFERSON**  
1 x 2 teeth



**104-0073**  
180mm (7")



**ADSON-BROWN**  
7 x 7 teeth



**104-0074**  
125mm (5")



**PENNYBACKER**  
3 x 4 teeth  
**104-0075**  
160mm (6.1/2")

## Toothed Dissecting Forceps ●●●

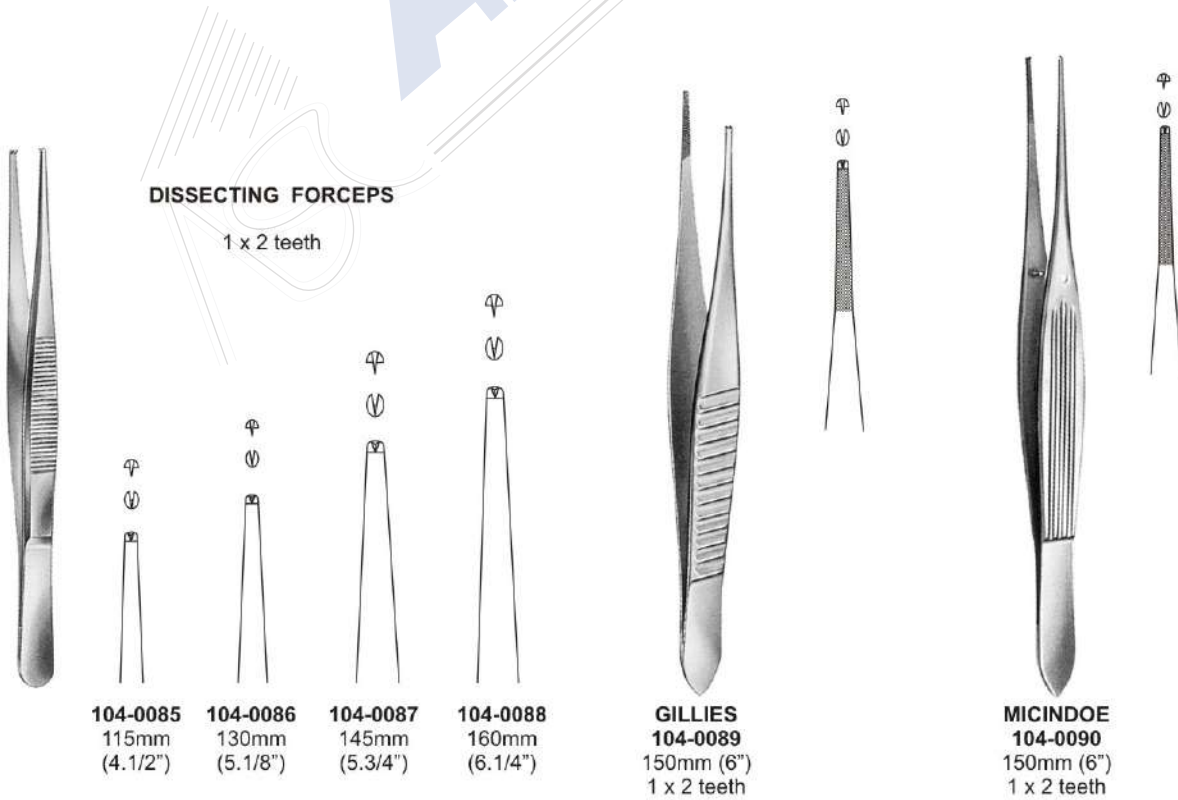
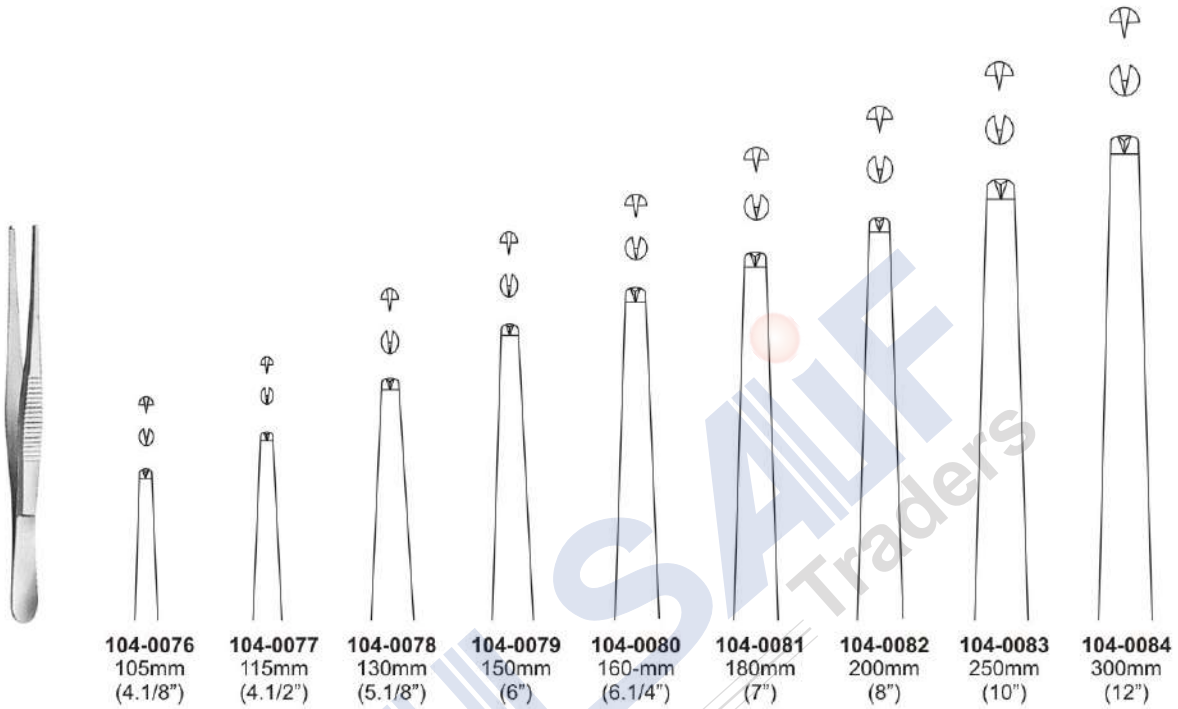

## ●●● Toothed Dissecting Forceps



**104-0091**  
**SILCOCK**  
1 x 2 teeth

**104-0092**  
100mm (4")  
**104-0093**  
110mm (4.3/8")



**104-0094**



**104-0095**  
**FINE**  
1 x 2 teeth  
**104-0096**  
100mm (4")  
**104-0097**  
100mm (4")



**104-0098**



**104-0099**



**104-0100**



**RAMSEY**  
180mm (7")



**BONNEY**  
1 x 2 teeth

**104-0101**  
180mm (7")

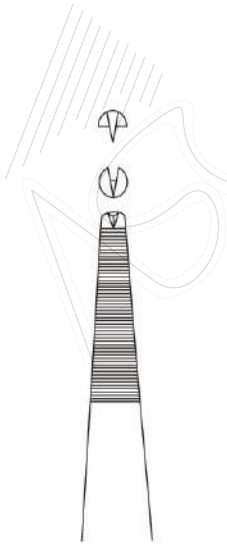

**BICKFORD**  
1 x 2 teeth

**104-0102**  
225mm (9")



**CANADIAN**  
2 x 3 teeth

**104-0103**  
140mm (5.1/2")

**104-0104**  
150mm (6")

## Toothed Dissecting Forceps ●●●

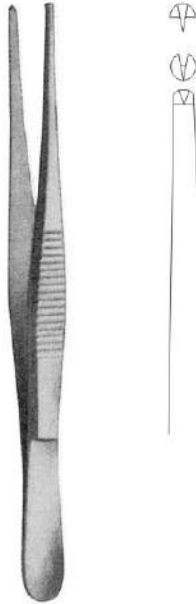

**ST MARKS**  
1 X 2 teeth  
**104-0105**  
290mm (11.1/2")

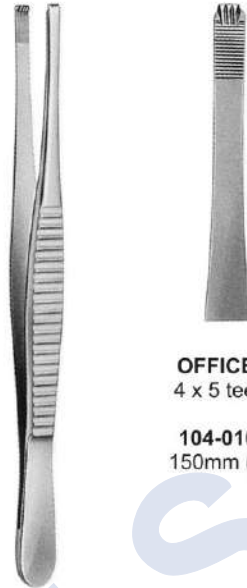

**OFFICER**  
4 x 5 teeth  
**104-0106**  
150mm (6")

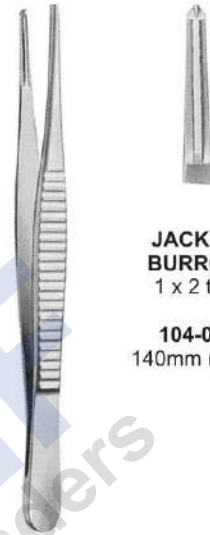

**JACKSON BURROWS**  
1 x 2 teeth  
**104-0107**  
140mm (5.1/2")



**MUSTARDE**  
Combined, double hooked jaw  
**104-0108**  
150mm (6")



**RUSSIAN**  
With circular jaw  
**104-0109**  
150mm (6")  
**104-0110**  
200mm (8")  
**104-0111**  
250mm (10")

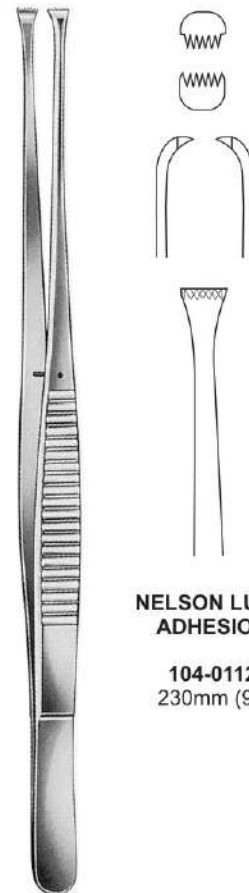

**NELSON LUNG ADHESION**  
**104-0112**  
230mm (9")

## ●●● Splinter Forceps

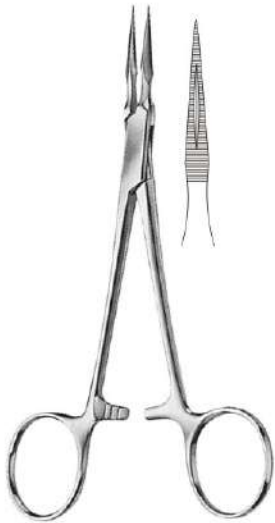

**104-0113  
ARTHURE**  
140mm (5.1/2")



**104-0114  
FEILCHENFEL**  
70mm (3")  
90mm (3.1/2")  
115mm (4.1/2")

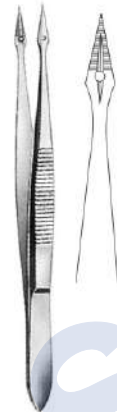

**104-0115  
HUNTER**  
105mm (4.1/8")

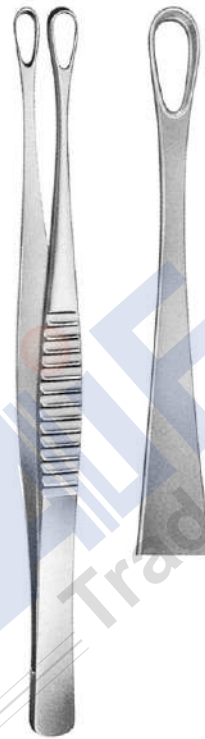

**DENIS BROWNE**  
**104-0116**  
190mm (7.1/2")



**MICRO SOFT TOUCH RING TIP**  
**104-0117**  
150mm (6")  
**104-0118**  
185mm ( 7.1/4")  
**104-0119**  
210mm (8.1/4")  
**104-0120**  
230mm (9")  
**104-0121**  
250mm (10")

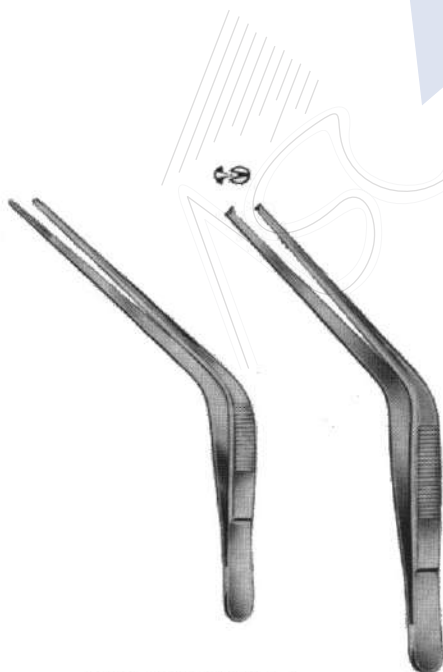

**TROELTSCH (Wilde)**  
**104-0122**  
110mm (4.1/2")

**TROELTSCH (Wilde)**  
**104-0123**  
120mm (4.3/4")  
1 x 2 teeth



**TUDICHUM**  
**104-0124**  
65mm (2.3.1/2")

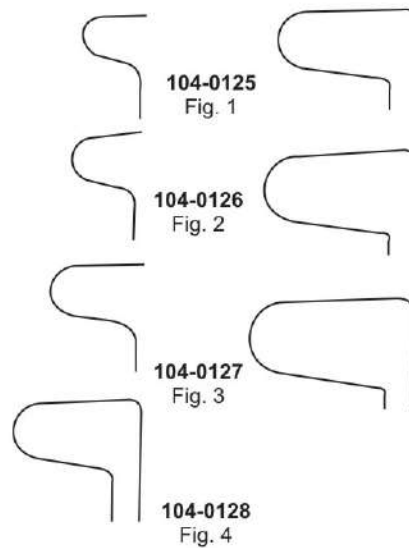

**104-0125**  
Fig. 1

**104-0126**  
Fig. 2

**104-0127**  
Fig. 3

**104-0128**  
Fig. 4



## Dissecting & Ligature Forceps ●●●



**LIGATURE FORCEPS**  
105-0001  
95mm (3.3/4")  
Straights, smooth jaw



**MICRO ADSON**  
105-0002  
140mm (5.1/2")

105-0003  
185mm (7.1/4")

105-0004  
210mm (8.1/4")

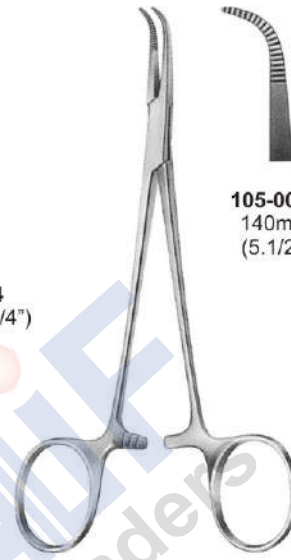

**BABY - ADSON**

105-0005  
140mm  
(5.1/2")

105-0006  
180mm  
(7")

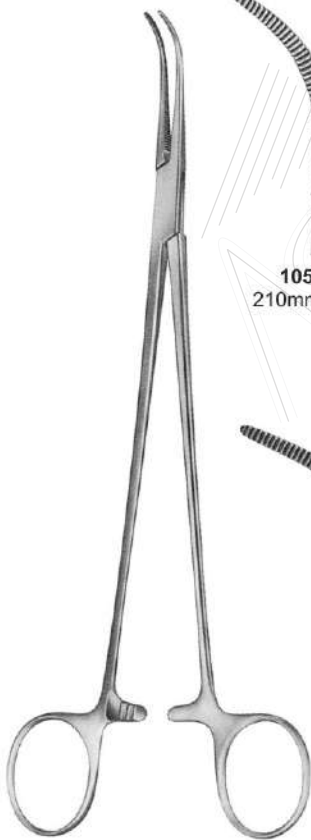

**FINE CURVED DISSECTING FORCEPS**



105-0007  
210mm (8.1/4")



105-0008  
215mm (8.1/2")



105-0009  
220mm (8.3/4")

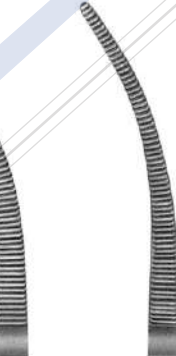

105-0010  
225mm (9")



105-0011  
225mm (9")



105-0012  
295mm (11.3/4")



105-0013  
295mm (11.3/4")



105-0014  
300mm (12")

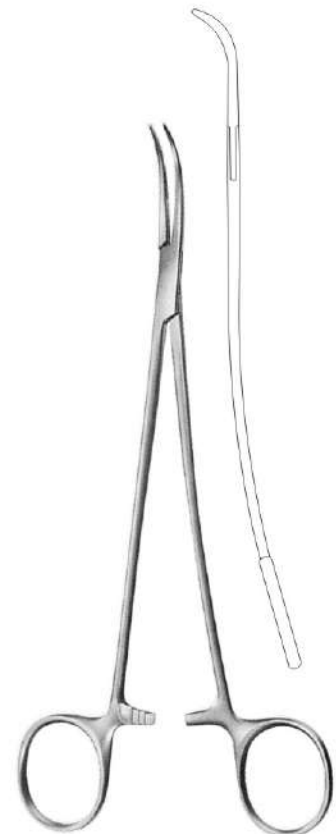

**S.SHAPED DELICATE**

## ● ● ● Dissecting & Ligature Forceps

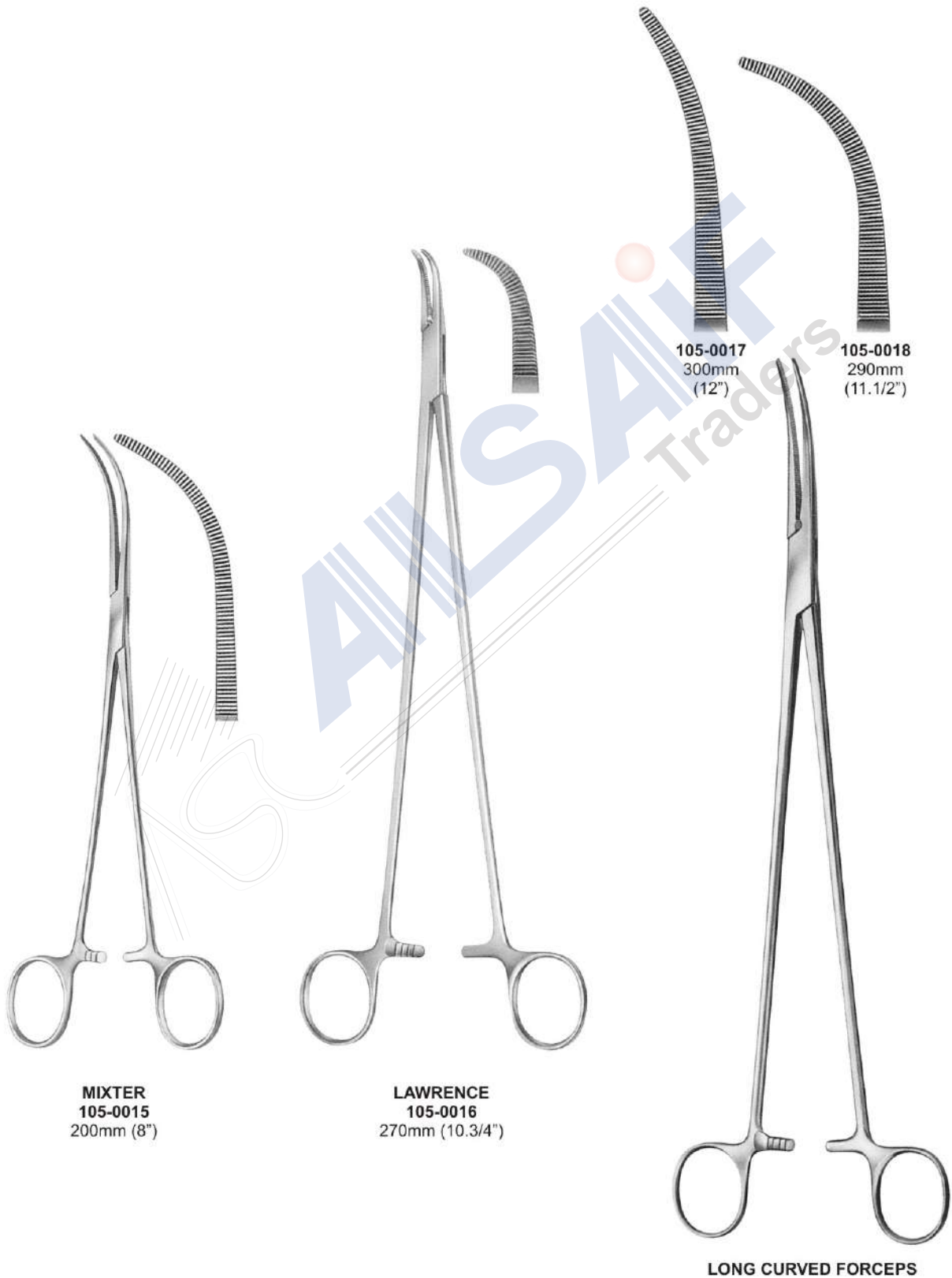



**RUTHERFORD MORISON**  
 105-0019 150mm (6")  
 6 x 7 teeth



**STILES (ALLIS-THOMS)**  
 105-0020 200mm (8")  
 6 x 7 teeth

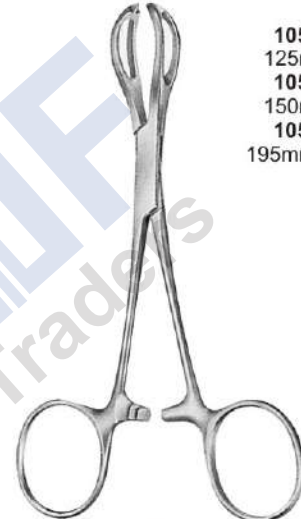

**LANE**  
 1 x 2 teeth fenestrated



- 105-0021 125mm (5")
- 105-0022 150mm (6")
- 105-0023 195mm (7.3/4")



**BABCOCK**  
 105-0024 165mm (6.1/2")

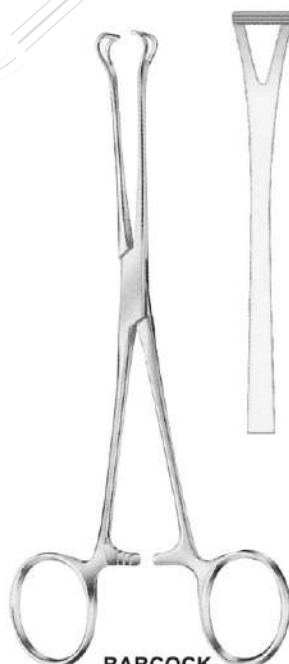

**BABCOCK**  
 105-0025 200mm (8")  
 Extra light

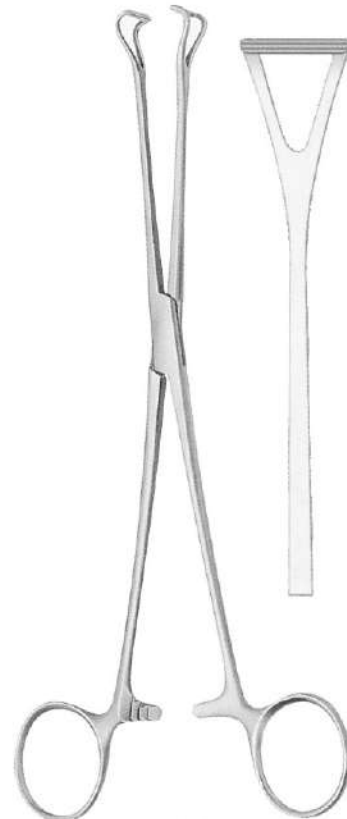

**BABCOCK**  
 105-0026 230mm (9")

## ●●● Tissue Forceps



**ALLIS**  
 150mm (6")  
 105-0027 2 x 3 teeth  
 105-0028 3 x 4 teeth  
 105-0029 4 x 5 teeth  
 105-0030 5 x 6 teeth  
 105-0031 6 x 7 teeth



105-0032



105-0033

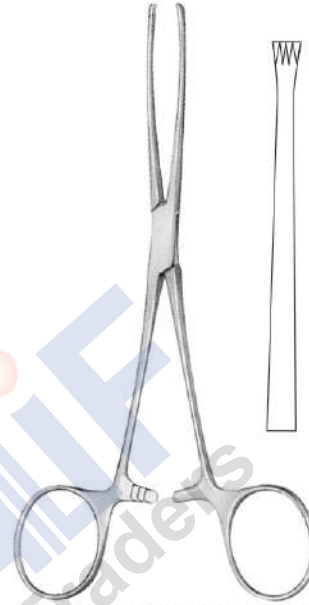

**AMERICAN PATTERN ALLIS**  
 105-0034 150mm (6") 3 x 4 teeth



**JUD-ALLIS**  
 105-0035 195mm (7.3/4")  
 Light pattern, 3 x 4 teeth

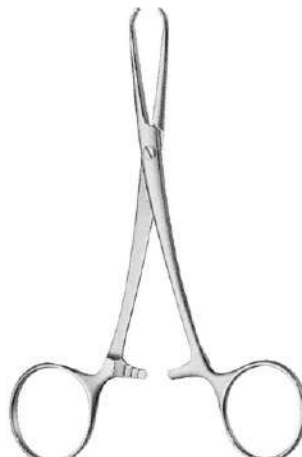
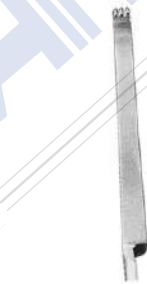

**CHAPUT (POIRIER)**  
 105-0036 125mm (5") 2 x 3 teeth

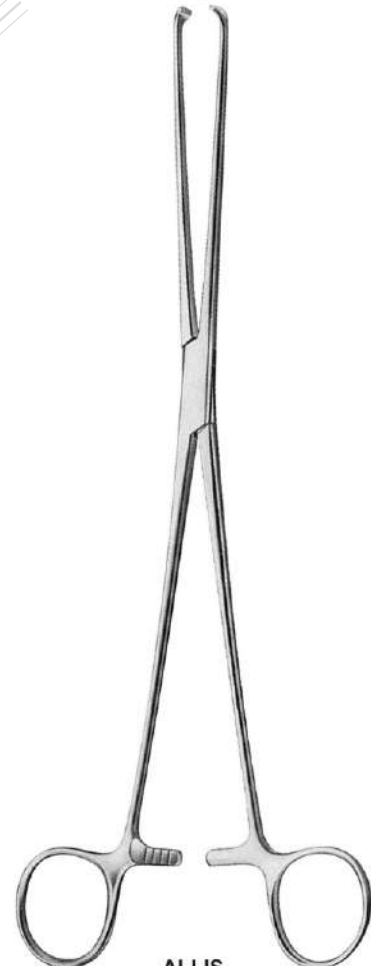

**ALLIS**  
 105-0037 190mm (7.1/2")  
 105-0038 255mm (10") 5 x 6 Teeth

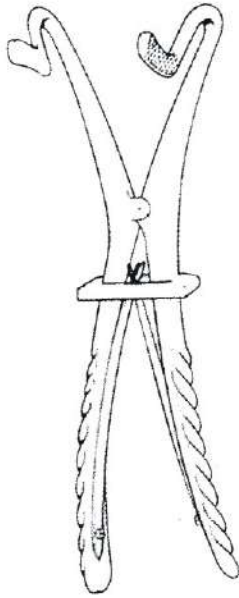

**FERGUSSON ACLAND**

**105-0039**  
170mm (6.3/4")

**105-0040**  
200mm (8")



**DOYEN (CHILD)**

**105-0041**  
120mm (4.3/4")

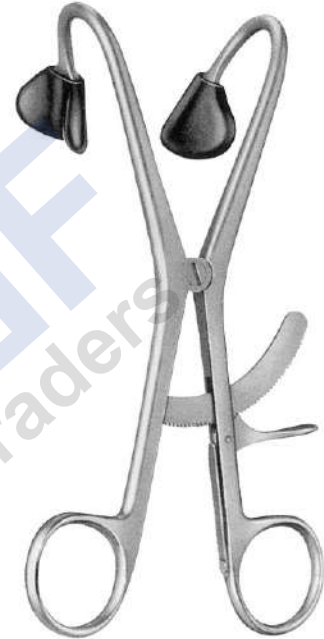

**FEATHERSTONE**

**105-0042**  
165mm (6.1/2")



**DOYEN (ADULT)**

**105-0043**  
140mm (5.1/2")

## ●●● Tongue Depressors



**105-0044**  
180mm (7")

**FLAT TONGUE DEPRESSOR**  
Double ended  
tapering 19mm + 23mm



**105-0045**  
140mm (5.1/2")

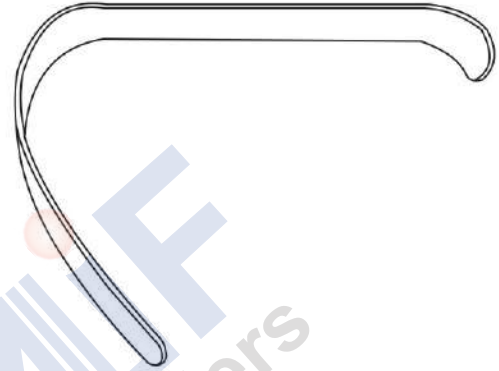

**LACK TONGUE DEPRESSOR**  
**105-0046** 13mm wide  
child  
**105-0047** 19mm wide  
Adolescent  
**105-0048** 22mm wide  
Adults

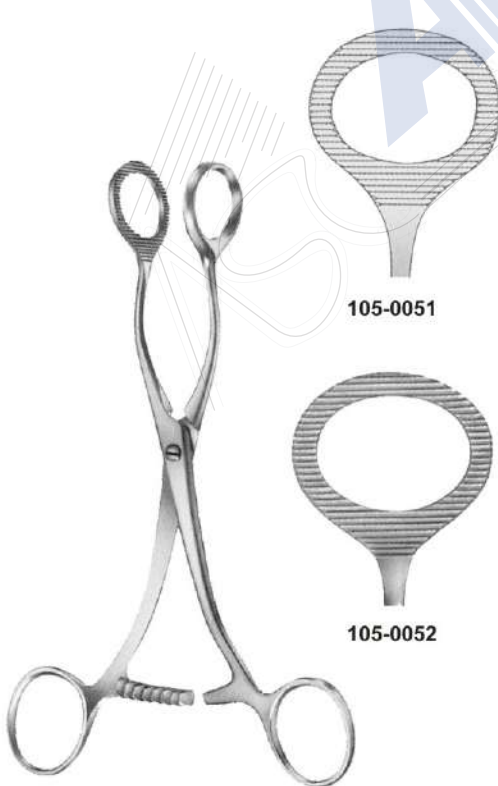

**COLLIN TONGUE FORCEPS**  
**105-0049** 170mm (6.3/4")  
**105-0050** 160mm (6.1/4")

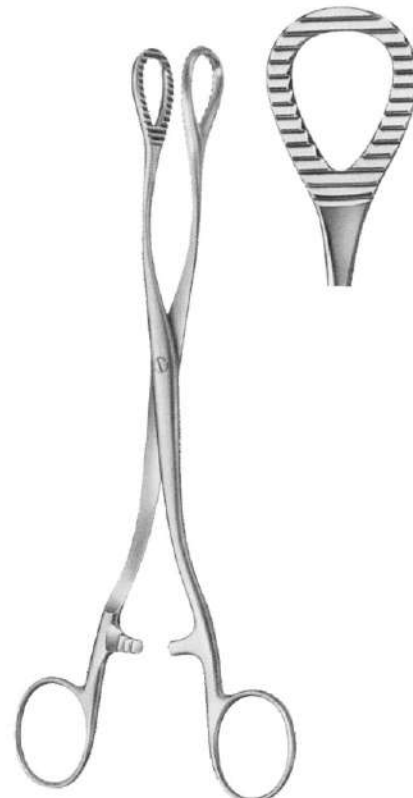

**HEYWOOD-SMITH TONGUE FORCEPS**  
**105-0053** 200mm (8")

## Towel Clamps ●●●

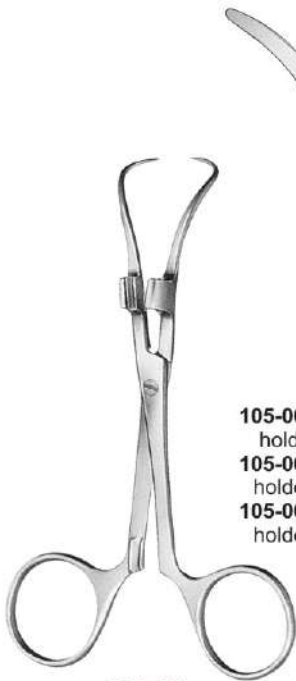

**ROBIN**

**105-0054** 140mm (5.1/2")  
holder diameter 5mm  
**105-0055** 140mm (5.1/2")  
holder diameter 13mm  
**105-0056** 140mm (5.1/2")  
holder diameter 25mm



**EDNA (LORNA)**  
**105-0057**  
100mm (4")

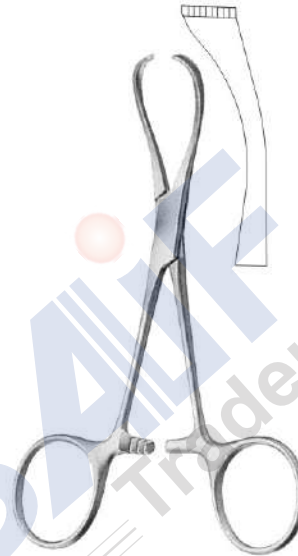

**EDNA (LORNA)**  
**105-0058**  
130mm (5.1/4")



**DOYEN**  
**105-0059**  
190mm (7.1/2")



**BALL AND SOCKET**  
**105-0062** 130mm (5")

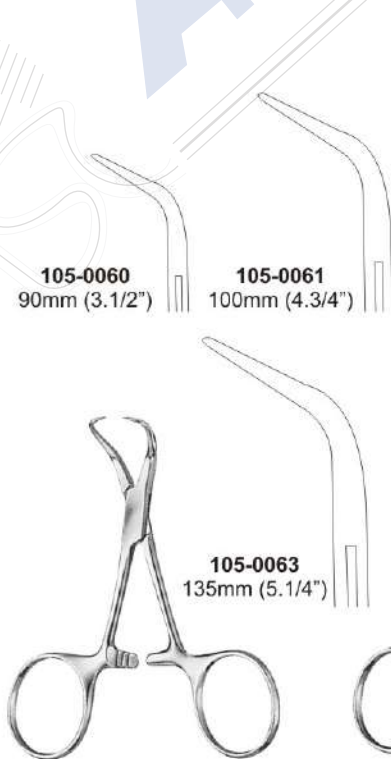

**BACKHAUS**

**105-0060**  
90mm (3.1/2")

**105-0061**  
100mm (4.3/4")

**105-0063**  
135mm (5.1/4")

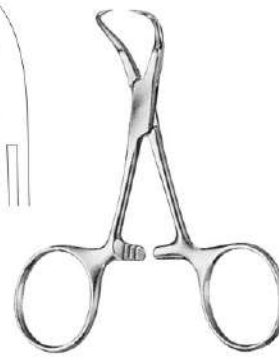

**MAYO**  
**105-0064** 140mm (5.1/2")

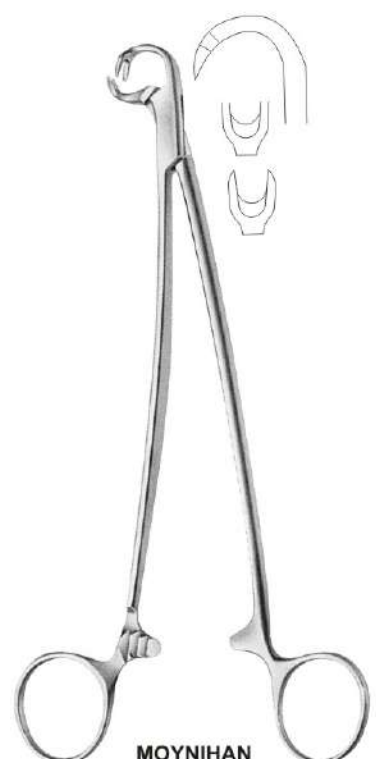

**MOYNIHAN**  
**105-0065**  
190mm (7.1/2") 2 x 2 teeth

## ●●● Sponge Holding Forceps

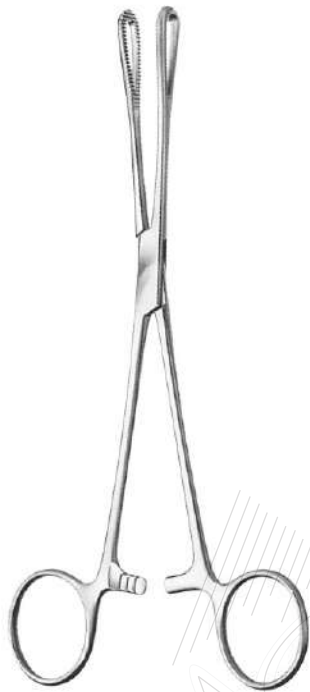

**RAMPLEY**

**105-0066**  
180mm (7")

**105-0067**  
240mm (9.1/2")

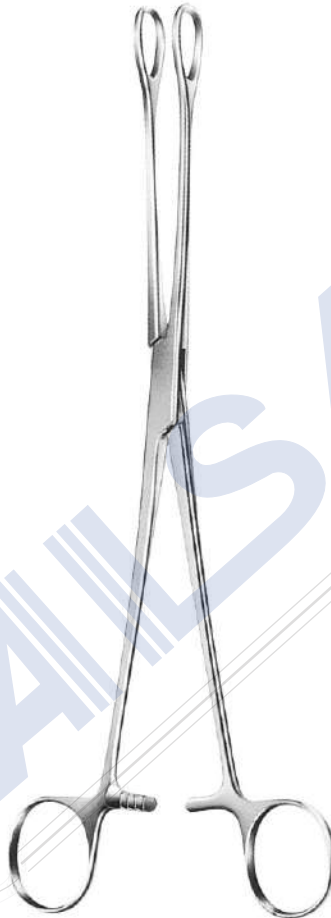

**FORESTER**

**105-0068**  
240mm (9.1/2")

**105-0069**  
180mm (7")  
Straight

**105-0070**  
240mm (9.1/2")

**105-0071**  
180mm (7")  
Curved on flat



**105-0072**



**105-0073**

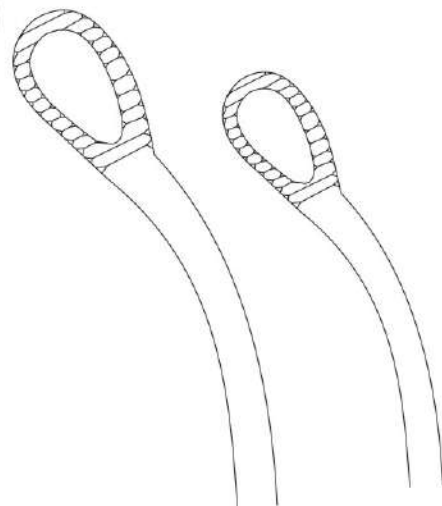

**105-0074**

**105-0075**



## Dressing Forceps ●●●

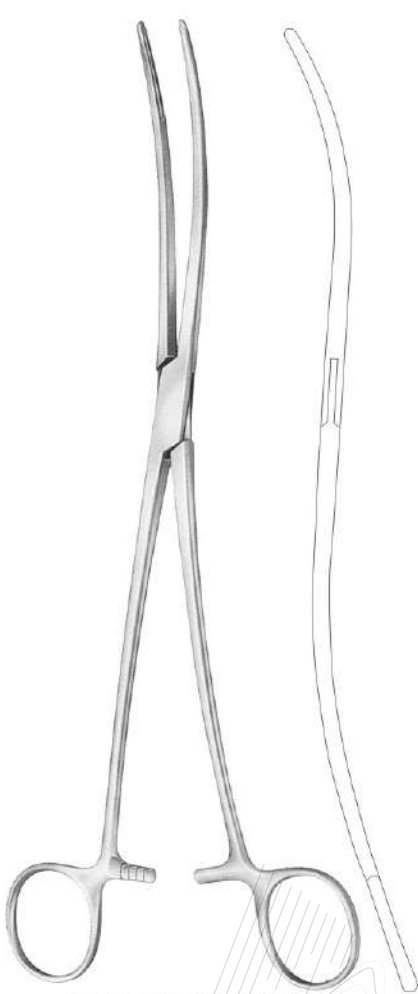

**BOZEMANN UTERINE DRESSING FORCEPS**  
**105-0076** 255mm (10")  
 Jaws with longitudinal groove

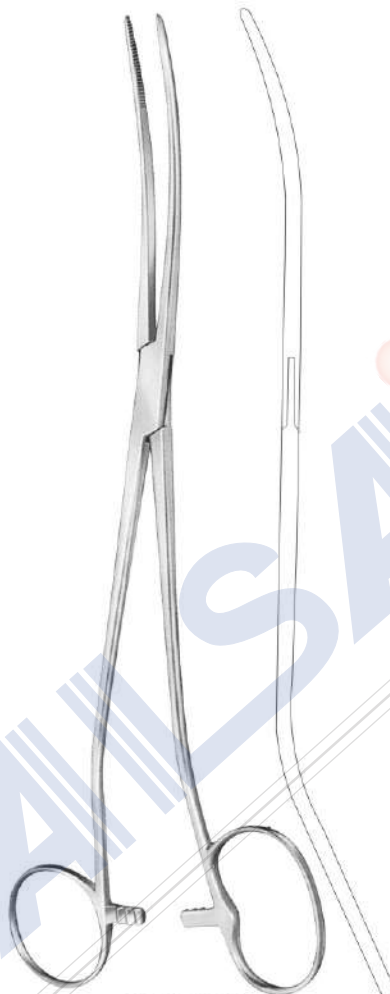

**BOZEMANN**  
**105-0077** 260mm (10.1/4")  
 Serrated jaws, on large bow

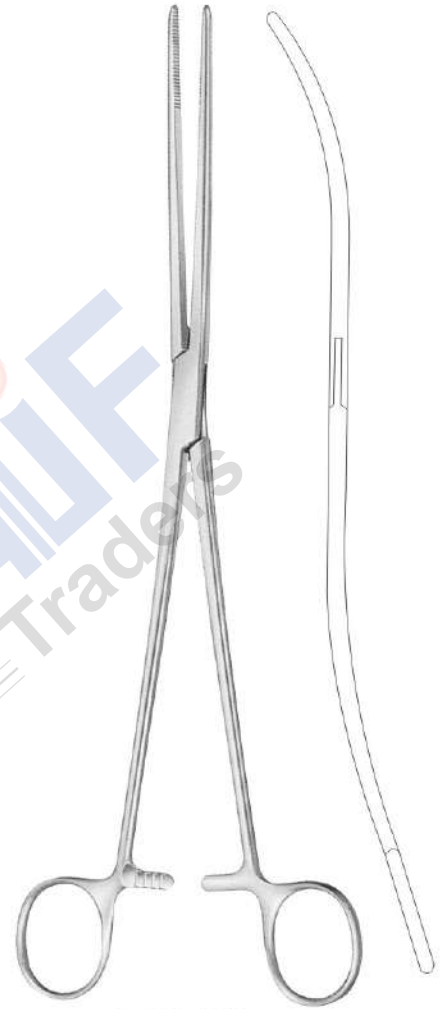

**BOZEMANN**  
**105-0078** 250mm (10")  
 S-shaped curve

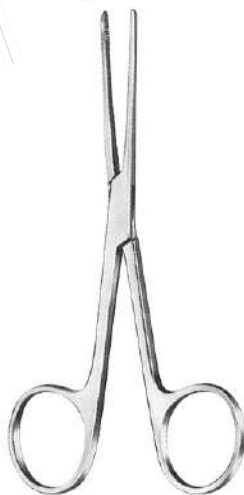

**LISTER - SINUS**



**105-0079**  
 125mm  
 (5")



**105-0080**  
 150mm  
 (6")



**105-0081**  
 180mm  
 (7")

## ●●● Haemostats Forceps



**HALSTEAD MOSQUITO**  
106-0001 100mm (4")  
Straight



**HALSTEAD MOSQUITO**  
106-0002 100mm (4")  
Curved on flat



**HALSTEAD MOSQUITO**  
100mm (4")  
1 x 2 teeth  
106-0003  
Straight  
106-0004  
Curved on flat

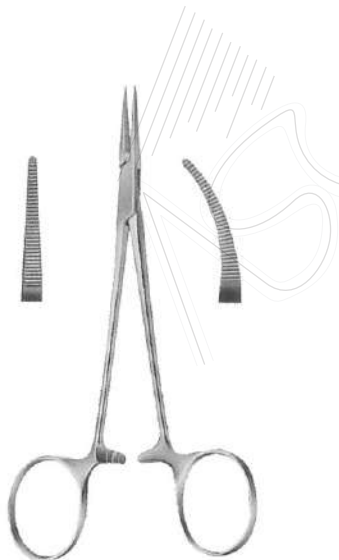

**HALSTEAD MOSQUITO**  
125mm (5")  
106-0005  
Straight  
106-0006  
Curved on flat



**HALSTEAD MOSQUITO**  
125mm (5")  
1 x 2 teeth  
106-0007  
Straight  
106-0008  
Curved on flat



**BABY - CRILE**  
106-0009  
140mm (5.1/2")  
Straight



**BABY-CRILE**  
106-0010 140mm (5.1/2")  
Curved on flat



**BABY-CRILE**  
106-0011 140mm (5.1/2")  
Straight  
1 x 2 teeth



**BABY CRILE**  
106-0012 140mm (5.1/2")  
Curved on flat  
1 x 2 teeth

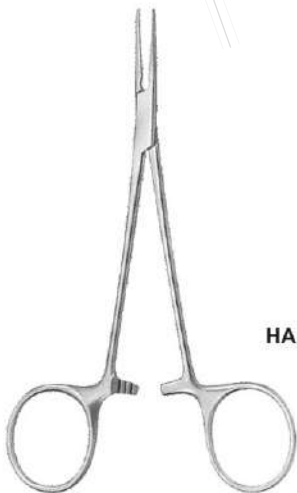
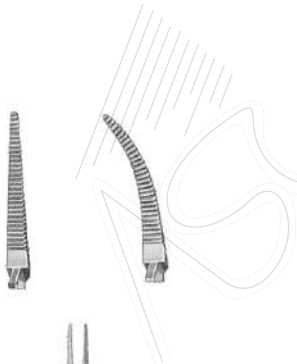

**HALSTEAD MOSQUITO**  
125mm (5")  
106-0013  
Straight  
106-0014  
Curved on flat



**HALSTEAD MOSQUITO**  
125mm (5")  
1 x 2 teeth  
106-0015  
Straight  
106-0016  
Curved on flat

## ●●● Haemostats Forceps

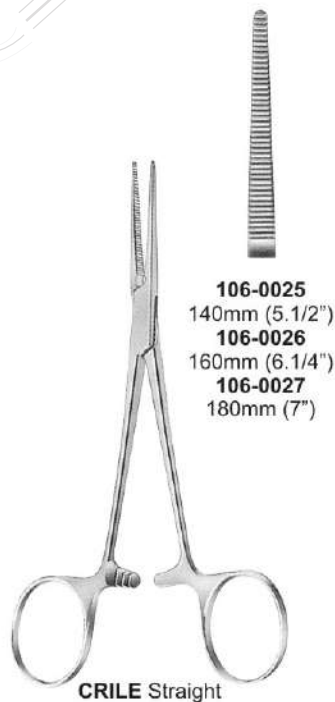
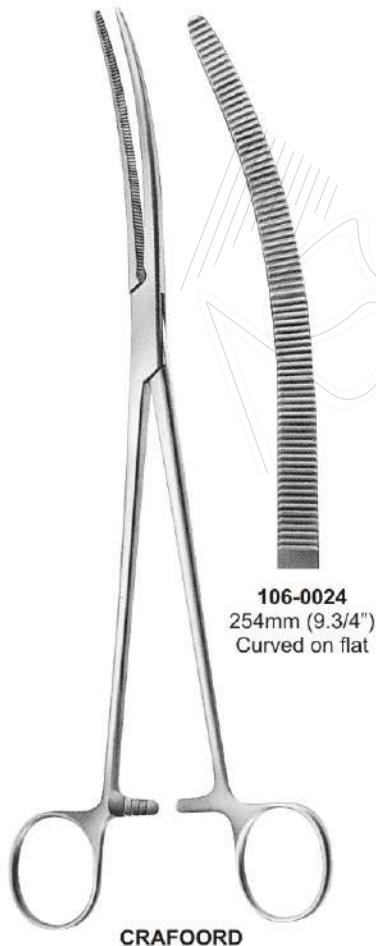
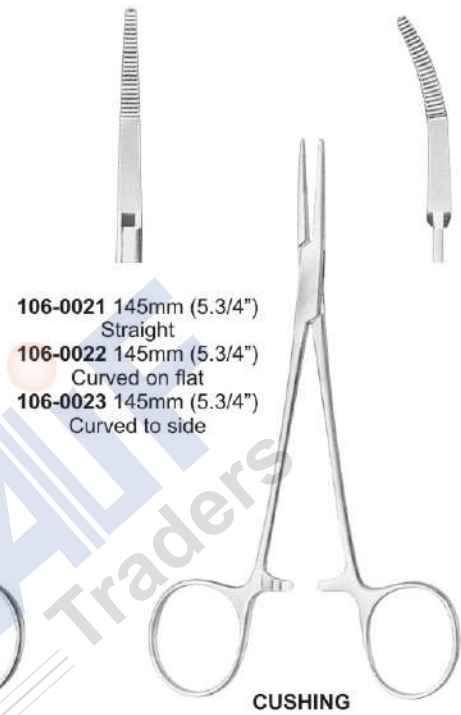



**CRILE**  
1 x 2 teeth  
106-0031 160mm (6.1/4")  
Straight  
106-0032 160mm (6.1/4")  
Curved on flat  
106-0033 140mm (5.1/2")  
Straight  
106-0034 140mm (5.1/2")  
Curved on flat



**CRILE**  
Curved on flat  
106-0035 140mm (5.1/2")  
106-0036 160mm (6.1/4")

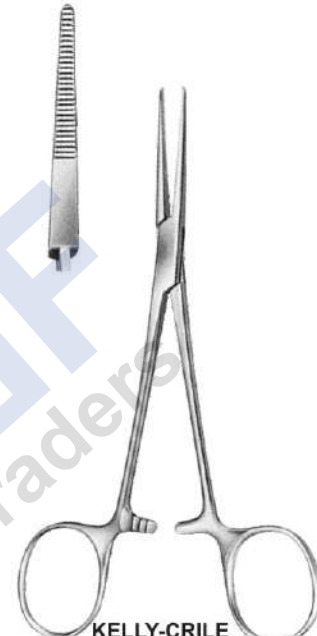

**KELLY-CRILE**  
Straight  
106-0037 140mm (5.1/2")  
106-0038 160mm (6.1/4")

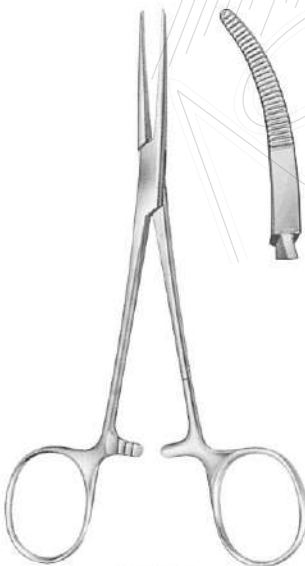

**KELLY**  
Curved on flat  
106-0039 140mm (5.1/2")  
106-0040 160mm (6.1/4")



**KELLY HALSTEAD**  
106-0041 140mm (5.1/2")  
Straight  
106-0042 140mm (5.1/2")  
Curved on flat



**KOCHER**  
Straight 1 x 2 teeth  
106-0043 125mm (5")  
106-0044 140mm (5.1/2")  
106-0045 150mm (6")  
106-0046 180mm (7")  
106-0047 200mm (8")  
106-0048 225mm (9")

## ●●● Haemostats Forceps



**KOCHER**  
 Curved on flat 1 x 2 teeth  
 106-0049 125mm (5")  
 106-0050 140mm (5.1/2")  
 106-0051 150mm (6")  
 106-0052 180mm (7")  
 106-0053 200mm (8")  
 106-0054 225 (9")



**106-0055**  
 260mm (10.1/4")  
 Curved on flat

**LLOYD DAVIS**

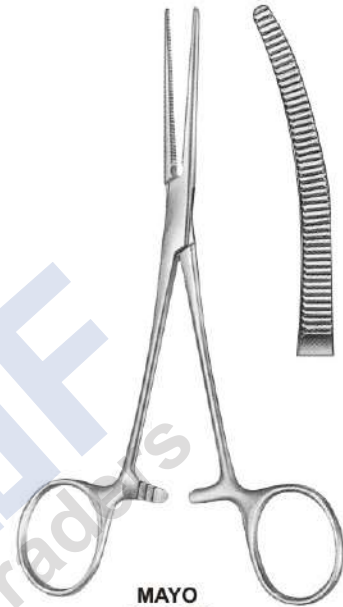

**MAYO**  
 106-0056  
 160mm (6.1/4")  
 Curved on flat



**ROCHESTER - OSCHNER**  
 Straight 1 x 2 teeth

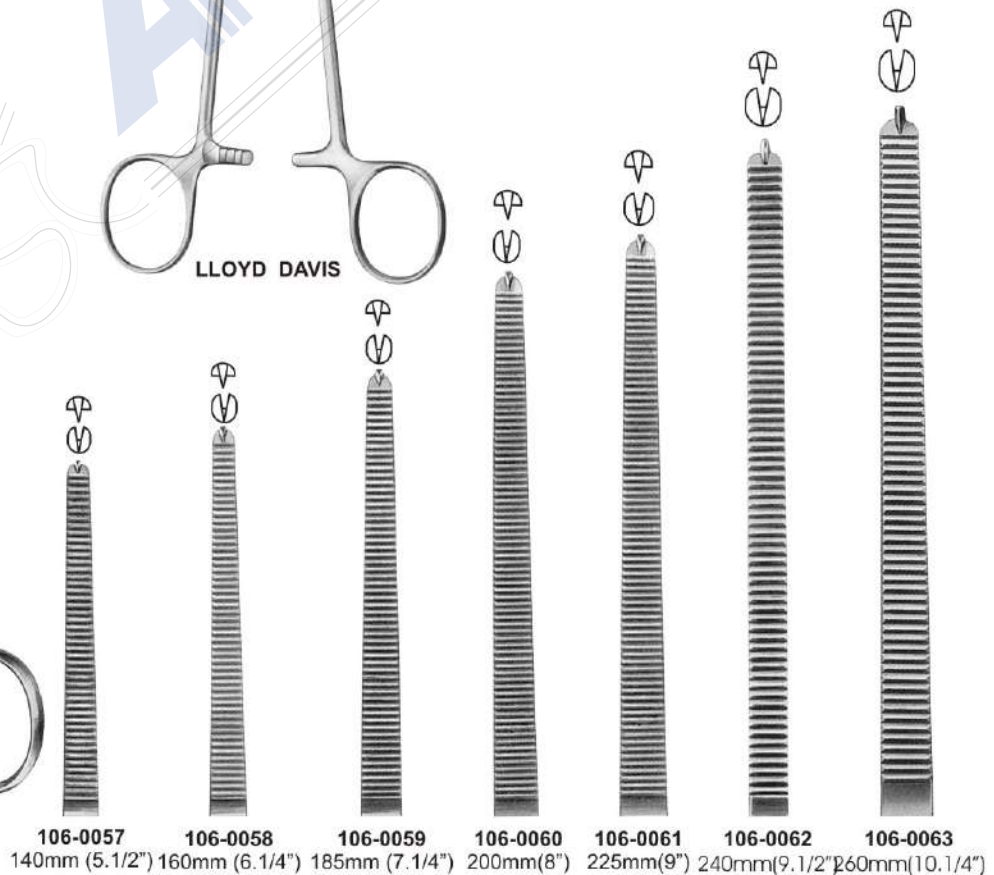

**106-0057** 140mm (5.1/2") **106-0058** 160mm (6.1/4") **106-0059** 185mm (7.1/4") **106-0060** 200mm(8") **106-0061** 225mm(9") **106-0062** 240mm(9.1/2") **106-0063** 260mm(10.1/4")

## Haemostats Forceps ●●●



**ROCHESTER - OSCHNER**  
Curved  
1 x 2 teeth

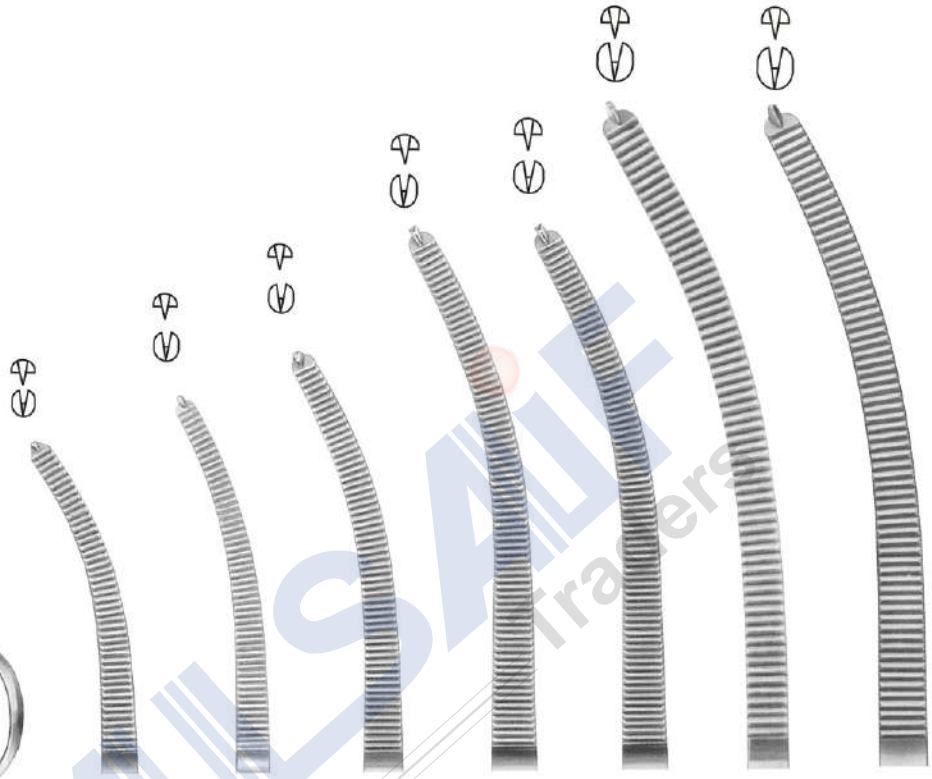

<b>106-0064</b> 140mm (5.1/2")	<b>106-0065</b> 160mm (6.1/4")	<b>106-0066</b> 185mm (7.1/4")	<b>106-0067</b> 200mm (8")	<b>106-0068</b> 225mm (9")	<b>106-0069</b> 240mm (9.1/2")	<b>106-0070</b> 260mm (10.1/4")
--------------------------------------	--------------------------------------	--------------------------------------	----------------------------------	----------------------------------	--------------------------------------	---------------------------------------



**FRASER-KELLY (CRILE)**  
106-0071 180mm (7") Curved on flat

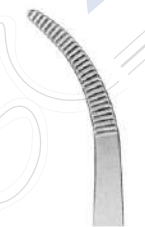

**106-0072**  
180mm (7")  
Curved on flat

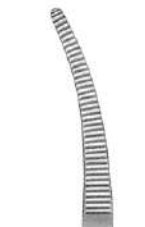

**106-0074**  
185mm (7.1/4")  
Curved on flat  
1 x 2 teeth



**106-0073**  
180mm (7")  
Straight



**106-0075**  
185mm (7.1/4")  
Straight  
1 x 2 teeth



**FRASER - ADSON**



**DUNHILL**  
106-0076 125mm (5")  
Curved on flat  
106-0077 125mm (5")  
Straight  
106-0078 180mm (7")  
Curved on flat

## ●●● Haemostats Forceps

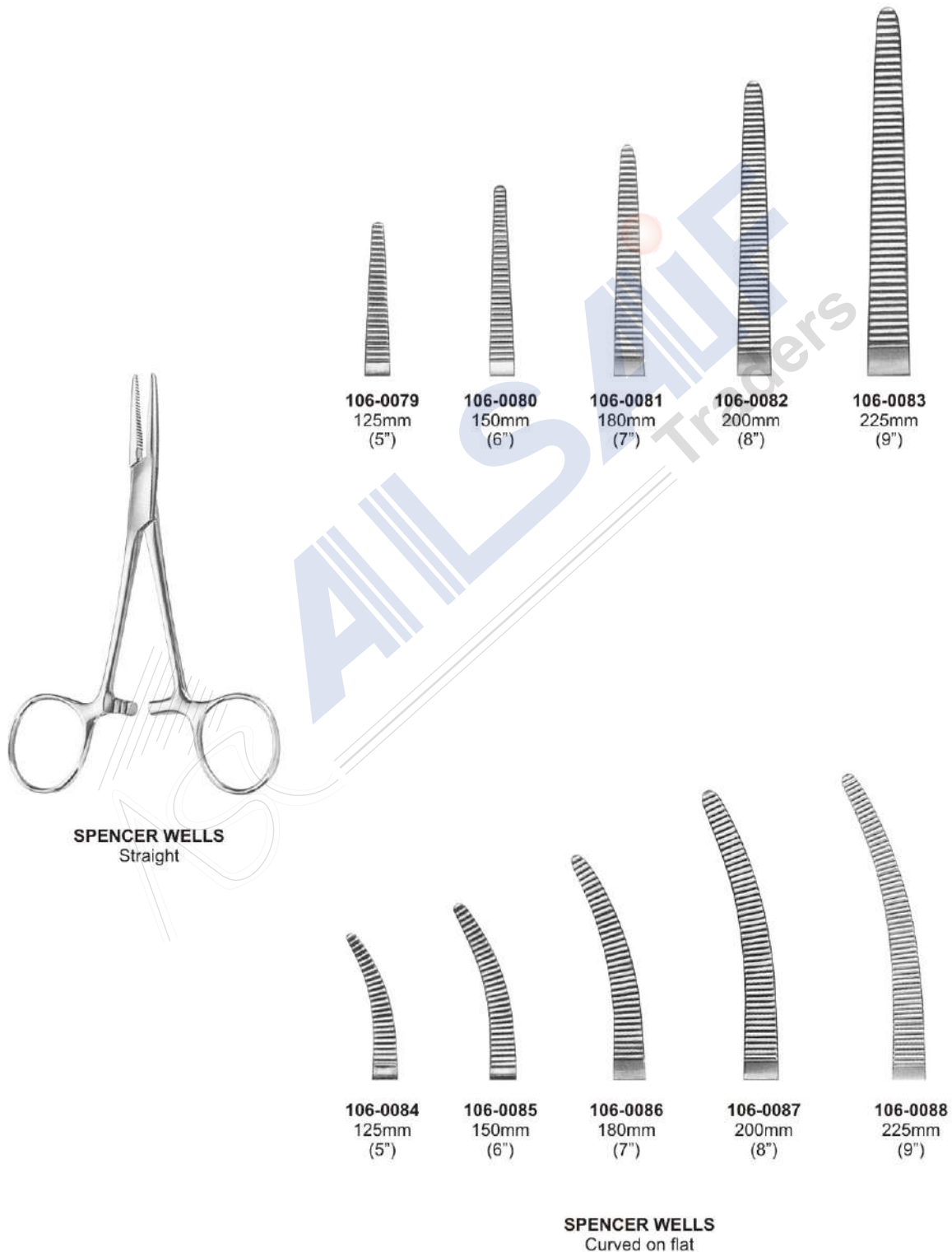



## Haemostats Forceps ●●●

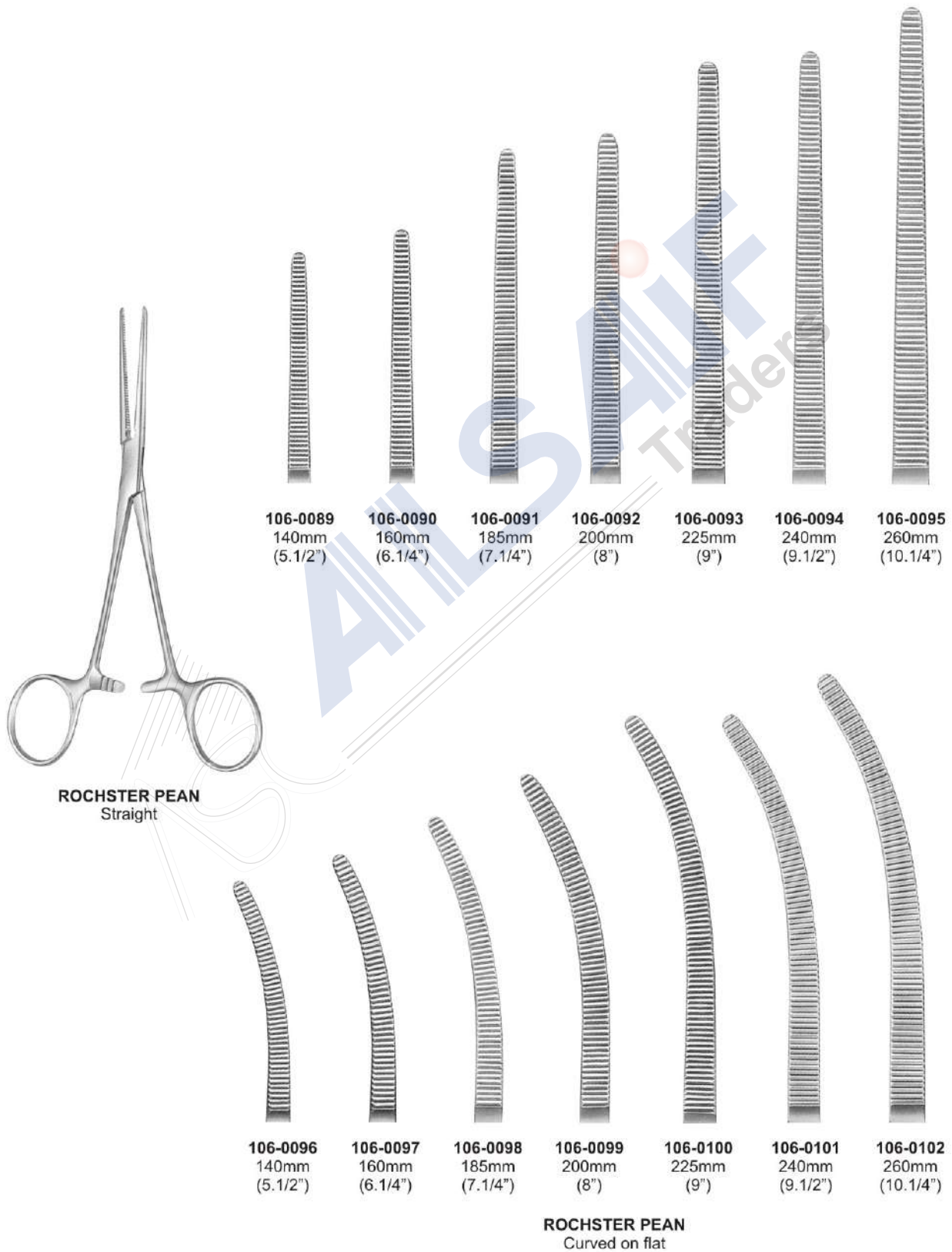

## ●●● Haemostats Forceps



**HEISS**  
**106-0103** 200mm (8")  
 Straight  
**106-0104** 200mm (8")  
 Curved on side  
**106-0105** 200mm (8")  
 Straight 1 x 2 teeth  
**106-0106** 200mm (8")  
 Curved on flat 1 x 2 teeth



**ROBERTS**  
 Curved on flat  
**106-0107** 230mm (9")  
 Screw joint  
**106-0108** 230mm (9")  
 Box joint

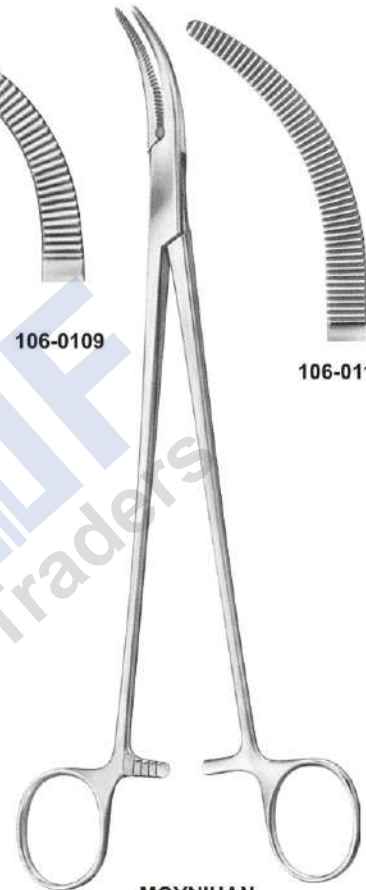

**MOYNIHAN**  
**106-0109** 230mm (9")  
**106-0110** 240mm (9.1/2")



**MIXTER**  
 Curved on flat



**106-0111**  
 140mm (5.1/2")



**106-0113**  
 180mm (7")



**106-0112**  
 230mm (9")



**106-0114** 180mm (7")  
 Straight  
**106-0115** 180mm (7")  
 Curved to side  
**106-0116** 180mm (7")  
 Curved on flat

## Haemostats Forceps ●●●



**106-0117**  
150mm  
(6")

**106-0118**  
180mm  
(7")

**106-0119**  
200mm  
(8")

**106-0120**  
230mm  
(9")

**106-0121**  
255mm  
(10")

**O'SHAUGHNESSY**  
Curved, lightweight



**TUBING CLAMP**  
Heavy pattern.  
wedge jaw

**106-0122**  
150mm (6")

**106-0123**  
180mm (7")

**106-0124**  
200mm (8")



**106-0125**

**106-0126**

**FICKLING ORAL**

**106-0127**  
180mm (7")  
Angled to side  
1 x 2 teeth

**106-0128**  
180mm (7")  
Angled to side

## ●●● Tonsil Artery Forceps



106-0129



106-0130

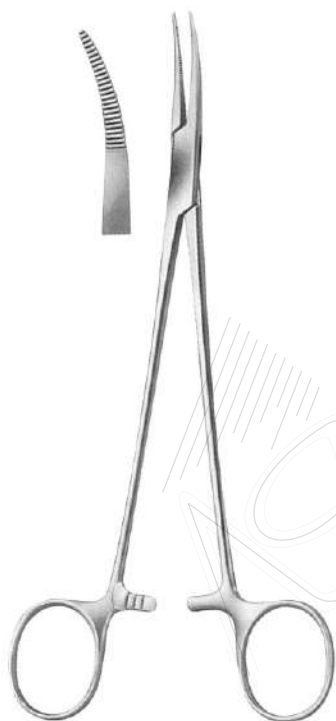

**SCHNIDT TONSIL**

**106-0131**  
180mm (7")  
Slight curved on flat

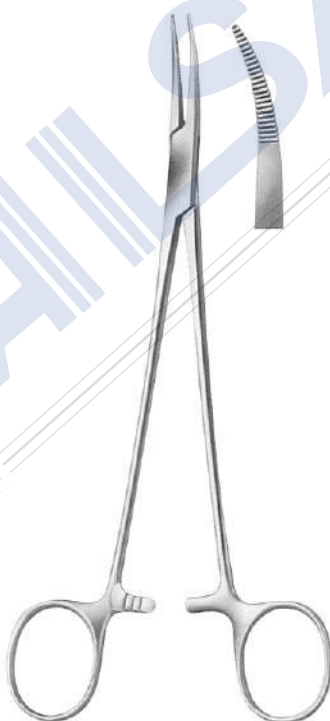

**NEGUS TONSIL**

**106-0132**  
180mm (7")  
Small curved

**106-0133**  
180mm (7")  
Large curved



**WILSON TONSIL**

**106-0134**  
190mm (7.1/2")  
Curved on flat  
Angled shafts



**CASTROVIEJO**  
 107-0001  
 145mm (5.3/4")  
 With catch



**CASTROVIEJO**  
 107-0002  
 145mm (5.3/4")  
 With catch



**ARRUGA**  
 107-0003  
 135mm (5.1/4")



**BARRAQUER**  
 107-0004  
 120mm (4.3/4")  
 With catch



**BARRAQUER**  
 107-0005  
 120mm (4.3/4")  
 Without catch



**CONVERSE**  
 107-0006  
 125mm (5")



**DERF**  
 107-0007  
 120mm (4.3/4")



**MAYO (DUNHILL)**  
 107-0008  
 160mm (6.1/4")



**MAYO**  
 107-0009  
 180mm (7")

## ●●● Needle Holders



**MAYO**  
107-0010 190mm (7.1/2")



**CRILE WOOD**  
107-0011 150mm (6")



**CRILE MURRAY**  
107-0012 145mm (5.3/4")



**KILNER**  
107-0013 135mm (5.1/4")



**NAUNTUN MORGAN**

107-0014  
190mm (7.1/2")  
107-0015  
250mm (10")



**WANGENSTEEN**

107-0016  
270mm (10.3/4")

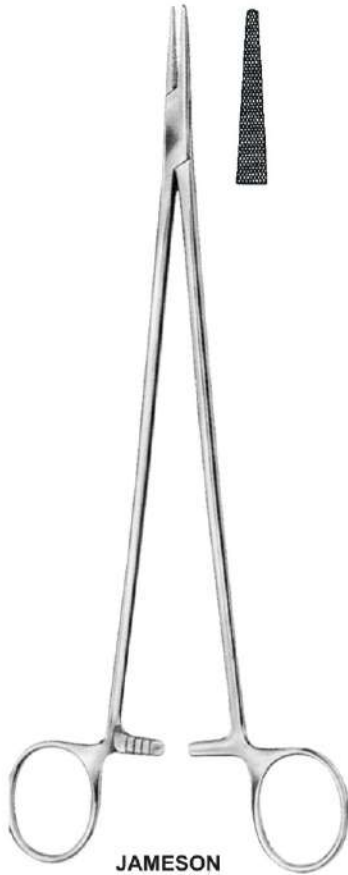

**JAMESON**  
107-0016 230mm (9")



**WRIGHT**  
107-0017 125mm (5")

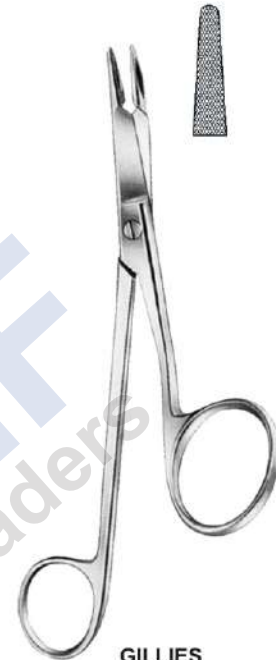

**GILLIES**  
Combined needle holder  
and scissors  
107-0018 160mm (6.1/4")

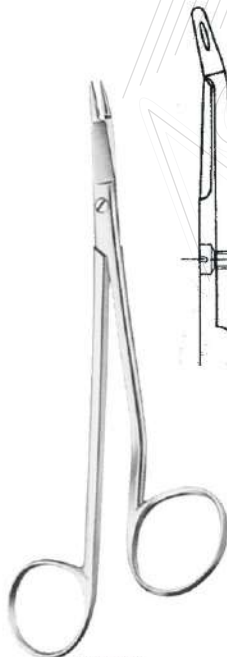

**WARD**  
Combined needle holder  
and scissors  
107-0019 180mm (7")



**HEANEY**  
107-0020 200mm (8")

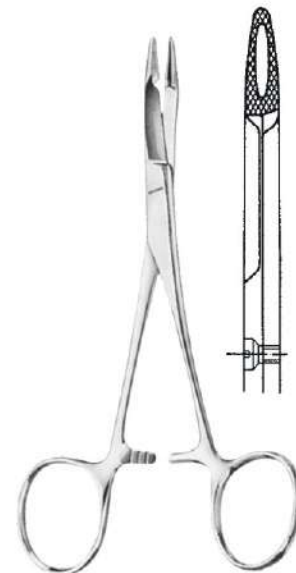

**OLSEN HEGAR**  
Combined needle holder  
and scissors  
107-0021 140mm (5.1/2")  
107-0022 165mm (6.1/2")  
107-0023 190mm (7.1/2")

● ● ● Needle Holders

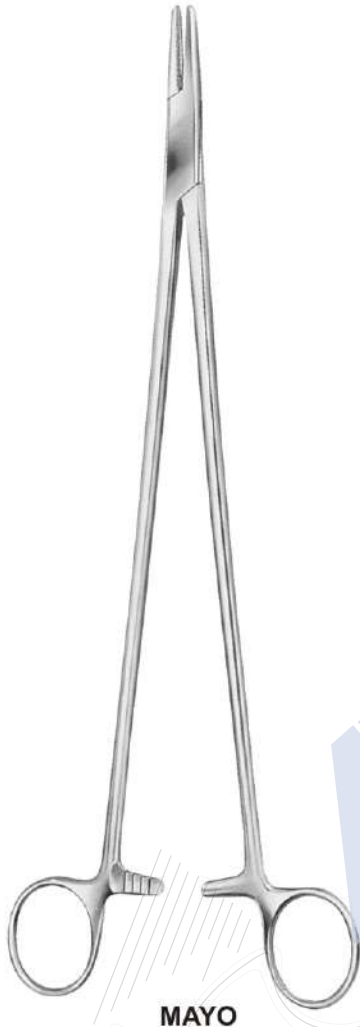

**MAYO (BAUMGARTNER)**  
107-0024 140mm (5.1/2")



**107-0028**  
200mm (8")



**MAYO (MASSON)**  
107-0025 265mm (10.1/2")



**107-0029**  
230mm (9")



**MAYO**  
107-0026 165mm (6.1/2")



**107-0027**  
190mm (7.1/2")



**HEGAR**  
107-0030  
200mm (8")

**MAYO**

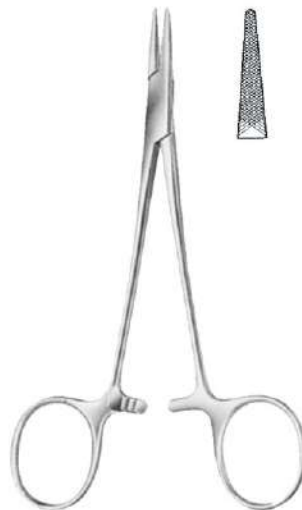

**HALSEY**  
107-0031  
125mm (5")



**MATHIEU**  
107-0032  
140mm (5.1/2")







**MATHIEU**  
**107-0033**  
 170mm (6.3/4")



**MATHIEU**  
**107-0034**  
 200mm (8")

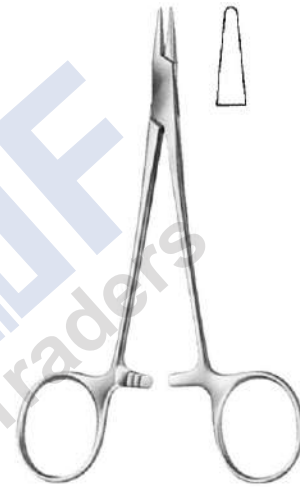

**WEBSTER**  
 Smooth Jaw  
**107-0035**  
 115mm (4.1/2")



**MAYO**  
**107-0036**  
 150mm (6")



**MCPHAILS**  
**107-0037**  
 180mm (7")



**LAWRANCE**  
**107-0038** 150mm (6")  
 Lightweight  
**107-0039** 150mm (6")

## ●●● Probes

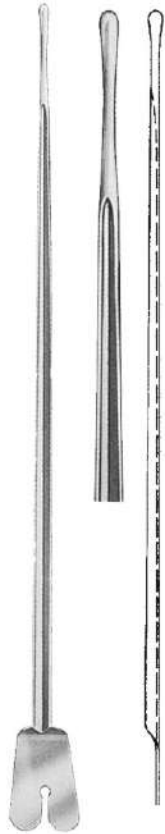

**BRODIE**  
**107-0040**  
200mm (8")  
Ball point



**DIRECTORS**  
**107-0041** 130mm (5.1/8")  
**107-0042** 145mm (5.3/4")  
**107-0043** 160mm (6.1/4")



**107-0044**  
140mm (5.1/2")



**SINUS**  
**107-0045**  
150mm (6")



**PROBE**  
With Eye

- PROBE**
- 107-0046**  
127mm (5")
- 107-0047**  
152mm (6")
- 107-0048**  
178mm (7")
- 107-0049**  
200mm (8")
- 107-0050**  
255mm (10")
- 107-0051**  
305mm (12")



**MYRTLE LEAF PROBE**  
**107-0052**  
145mm (5.3/4")



**1mm Tip**  
**107-0053**  
145mm (5.3/4")

- | 1.5mm tip                         | 2mm tip                           |
|-----------------------------------|-----------------------------------|
| <b>107-0054</b><br>130mm (5.1/8") | <b>107-0060</b><br>145mm (5.3/4") |
| <b>107-0055</b><br>145mm (5.3/4") | <b>107-0061</b><br>160mm (6.1/4") |
| <b>107-0056</b><br>160mm (6.1/4") | <b>107-0062</b><br>180mm (7")     |
| <b>107-0057</b><br>180mm (7")     | <b>107-0063</b><br>200mm (8")     |
| <b>107-0058</b><br>200mm (8")     |                                   |
| <b>107-0059</b><br>250mm (10")    |                                   |



**LIEBRICH LACHRYMAL**

**107-0064**

No. 00 - 0 (0.7 - 0.8mm)

**107-0065**

No. 1 - 2 (0.9 - 1.1mm)

**107-0066**

No. 3 - 4 (1.3 - 1.4mm)

**107-0067**

No. 5 - 6 (1.5 - 1.6mm)



**ANEL LACHRYMAL**

**107-0068**

108mm (4.1/4") 0.6mm , small



**JOBSON HORNE**

**107-0069** 140mm (5.1/2")

**107-0070** 178mm (7")



**FISTULA PROBE**

**107-0071** 240mm (9.1/2")



**KINGS COLLEGE HOSPITAL**

**COCAINISING WIRE**

**107-0072** 89mm (3.1/2")

**107-0073** 133mm (5.1/4")



**LOGAN TURNER**

**107-0074** 120mm (4.3/4")

1.00mm diameter



**CAWTHORNE**

**107-0075**

140mm (5.1/2")

● ● ● Dissectors

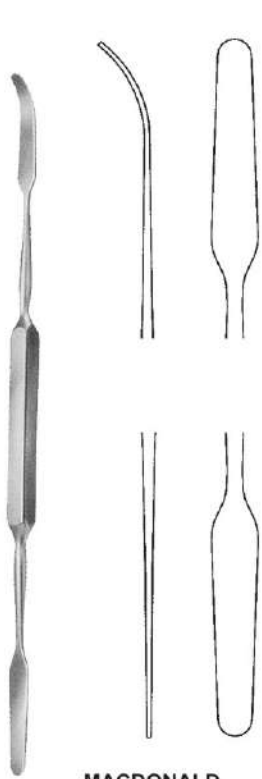

**MACDONALD**  
107-0076 185mm (7.1/4")  
Double ended



**WATSON CHEYNE**  
Fine with probe  
107-0077 125mm (5")  
107-0078 190mm (7.1/2")

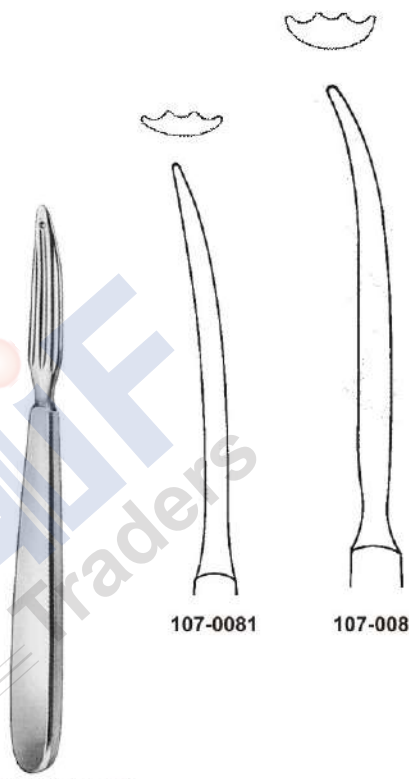

**KOCHER THYROID**  
107-0079 150mm (6")  
107-0080 170mm (6.3/4")

107-0081

107-0082

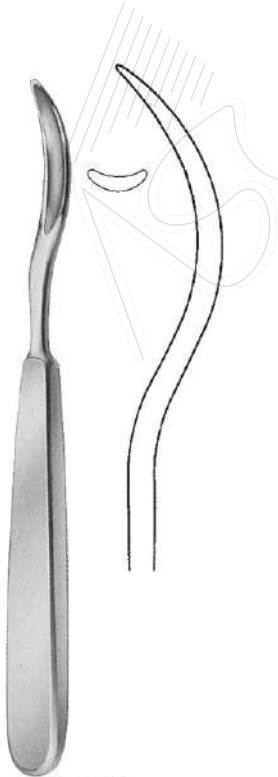

**KOCHER THYROID**  
107-0083 190mm (7.1/2")



**KING**  
107-0084 195mm (7.3/4")



**KING**  
107-0085 200mm (8")

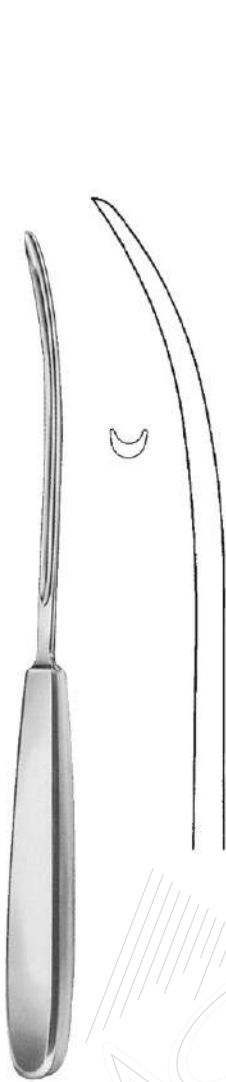

**PAYR**  
107-0086 225mm (9")

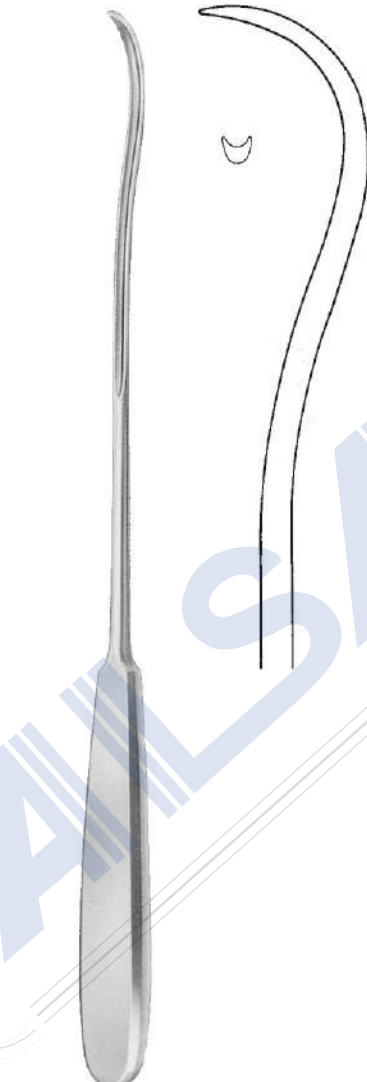

**PAYR**  
107-0087 280mm (11")



**GWYNNE EVANS TONSIL**  
200mm (8")  
Double ended  
107-0088 6mm wide  
107-0089 8mm wide

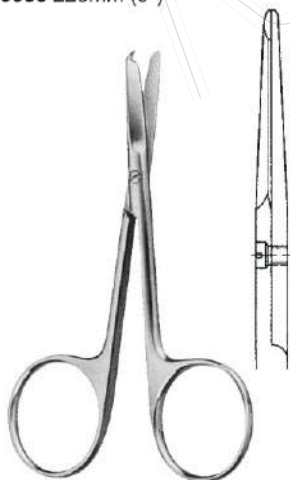

**LITTAUER**  
107-0090 110mm (4.1/2")  
With hook end



**LITTAUER (SPENCER)**  
107-0091 80mm (3.1/2")  
With hook end

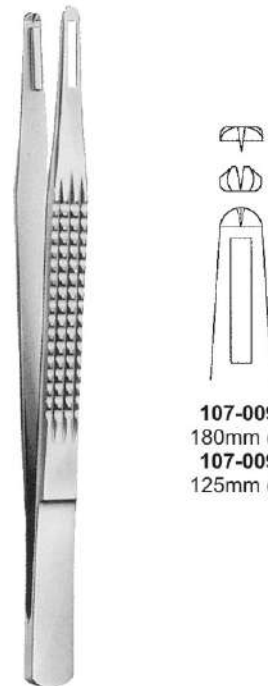

**CHARNLEY SUTURE  
FORCEPS**



107-0092  
180mm (7")  
107-0093  
125mm (5")

## ● ● ● Hand Held Retractors





**DEAVER GRIP**

**No 1**  
**108-0006**  
310mm (12.1/4")  
Blade: 25mm wide

**DEAVER GRIP**

**No 2**  
**108-0007**  
310mm (12.1/4")  
Blade: 38mm wide

**DEAVER GRIP**

**No 3**  
**108-0008**  
302mm (12")  
Blade: 50mm wide

**DEAVER GRIP**

**No 4**  
**108-0009**  
310mm (12.1/4")  
Blade: 75mm wide

## ●●● Hand Held Retractors



**RICHARDSON**  
240mm (9.1/2")



**108-0010**  
Blade: 23mm x 20mm

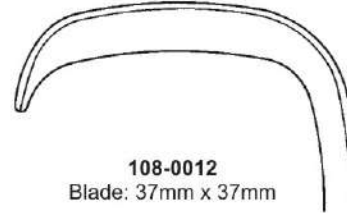

**108-0012**  
Blade: 37mm x 37mm

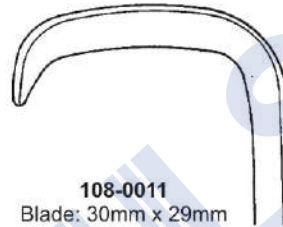

**108-0011**  
Blade: 30mm x 29mm

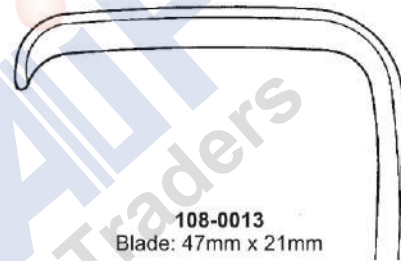

**108-0013**  
Blade: 47mm x 21mm

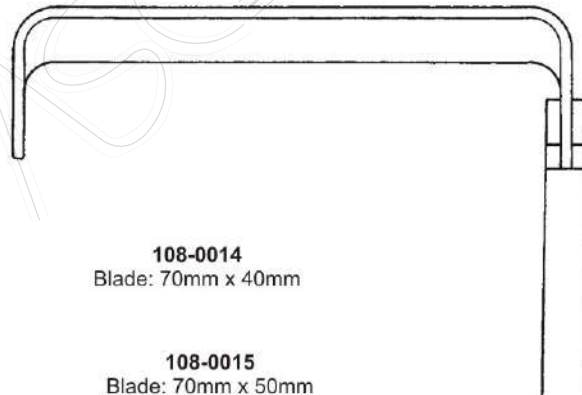

**108-0014**  
Blade: 70mm x 40mm

**108-0015**  
Blade: 70mm x 50mm

**108-0016**  
Blade: 70mm x 65mm



**MORRIS**  
245mm (9.3/4")  
Single blade



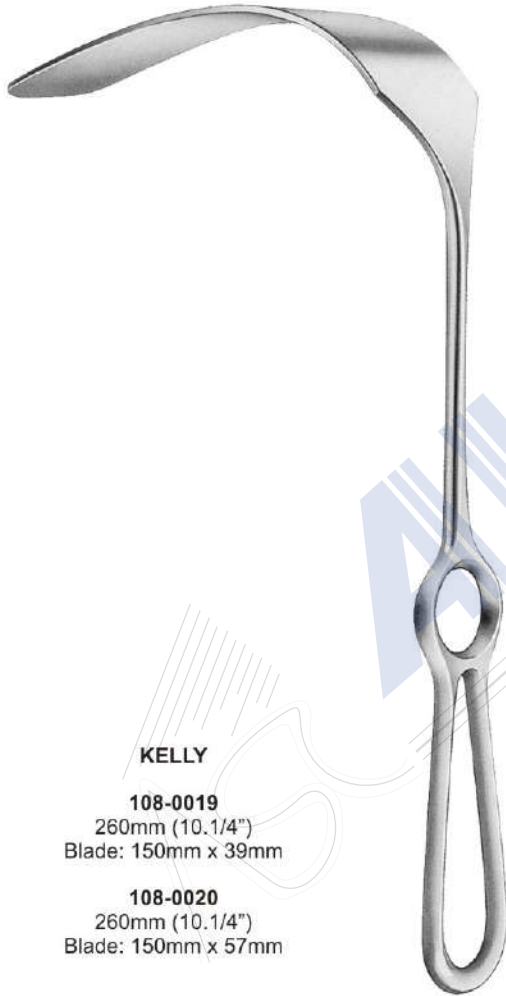
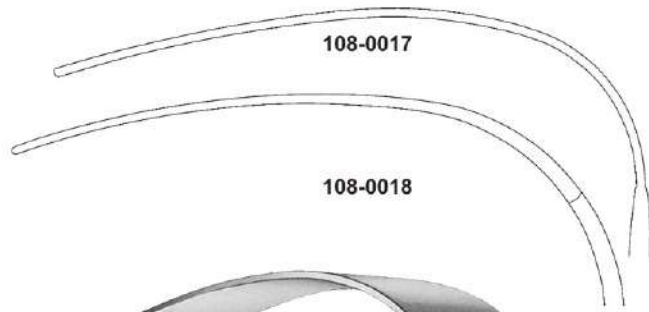

**KELLY**

**108-0019**  
 260mm (10.1/4")  
 Blade: 150mm x 39mm

**108-0020**  
 260mm (10.1/4")  
 Blade: 150mm x 57mm

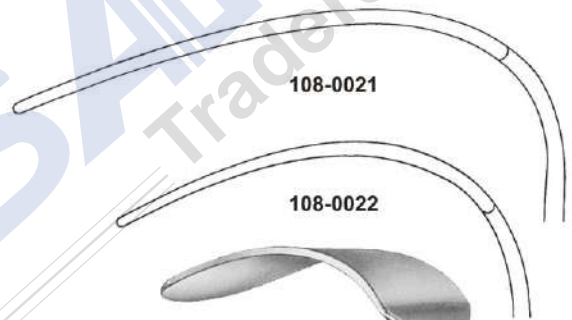

**LIVER RETRACTORS**  
 250mm (10")

**108-0022**  
 Blade: 91mm x 35mm

**108-0021**  
 Blade: 121mm x 50mm



## ●●● Hand Held Retractors



**MIDDELDORPF**



**108-0023**  
 220mm (8.3/4")  
 Blade: 15mm x 15mm



**108-0024**  
 215mm (8.1/2")  
 Blade: 20mm x 22mm



**108-0025**  
 235mm (9.1/4")  
 Blade: 28mm x 28mm

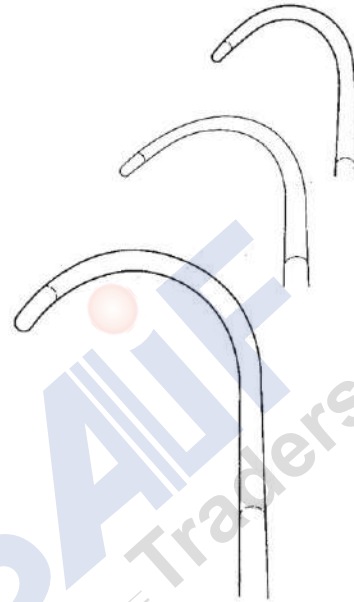

**DURHAM**  
 215mm (8.1/2")  
**108-0026** Blade: 10mm  
**108-0027** Blade: 16mm



**KOCHER**  
**108-0028** 230mm (9")  
 Blade: 36mm x 20mm



**MOYNIHAN**  
 205mm (8")  
**108-0029** Blade: 20mm x 15mm  
**108-0030** Blade: 20mm x 12mm



**108-0031**



**108-0032**

## Hand Held Retractors ●●●

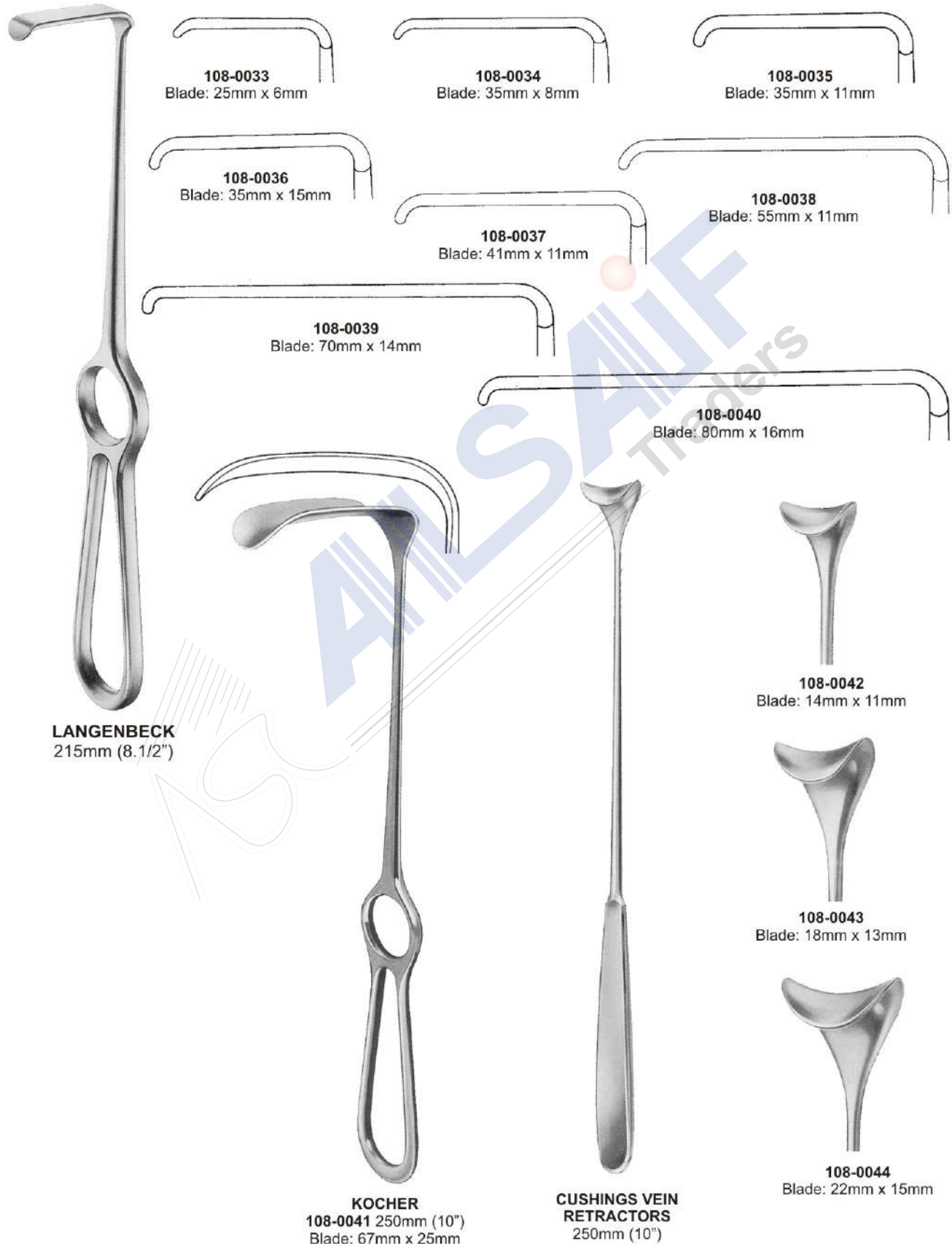

## ●●● Hand Held Retractors



**KOCHER**  
 230mm (9")

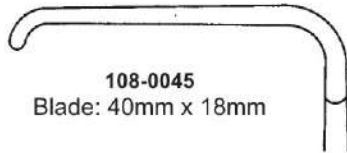

**108-0045**  
 Blade: 40mm x 18mm

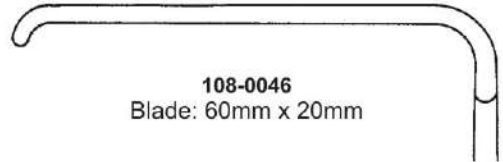

**108-0046**  
 Blade: 60mm x 20mm

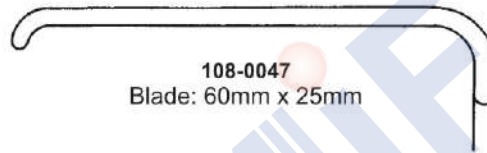

**108-0047**  
 Blade: 60mm x 25mm

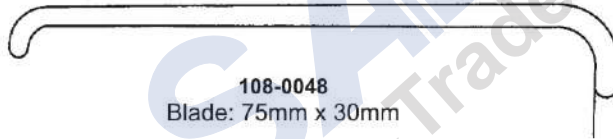

**108-0048**  
 Blade: 75mm x 30mm



**108-0049**  
 Blade: 75mm x 40mm



**FARABEUF 125mm (5")**  
**108-0050**  
 Set consisting of  
 Inner blade: 22mm x 10mm  
 28mm x 12mm  
 Outer blade: 25mm x 10mm  
 32mm x 12mm



**FARABEUF 150mm (6")**  
**108-0051**  
 Set consisting of  
 Inner blade: 20mm x 16mm  
 24mm x 16mm  
 Outer blade: 23mm x 16mm  
 28mm x 16mm



**WALTON**  
 305mm (12") Malleable  
**108-0052** 13mm wide  
**108-0053** 25mm wide  
**108-0054** 38mm wide  
**108-0055** 51mm wide



**SIMON**  
**108-0056**  
 220mm (8.3/4")



**DOYEN**  
**108-0057** 250mm (10")  
 Blade: 53mm x 80mm

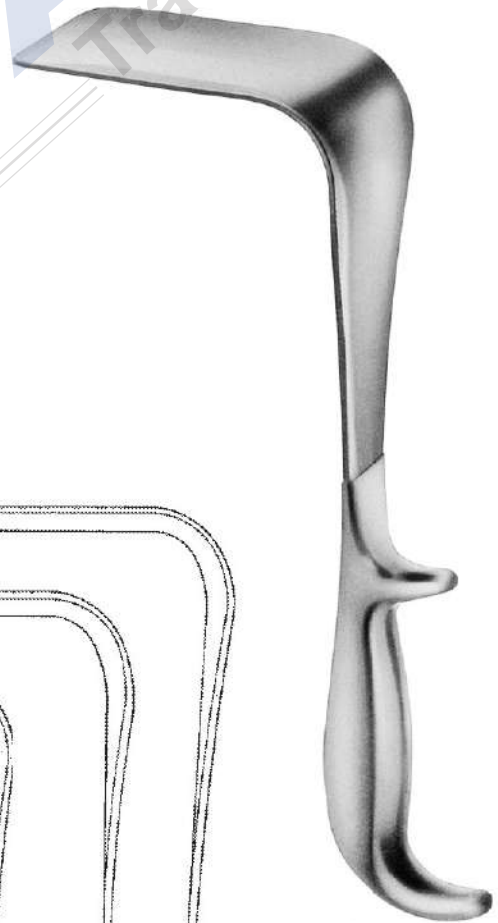

**DOYEN**  
 240mm (9.1/2")  
**108-0058**  
 Blade: 60mm x 45mm  
**108-0059**  
 Blade: 90mm x 45mm  
**108-0060**  
 Blade: 120mm x 45mm

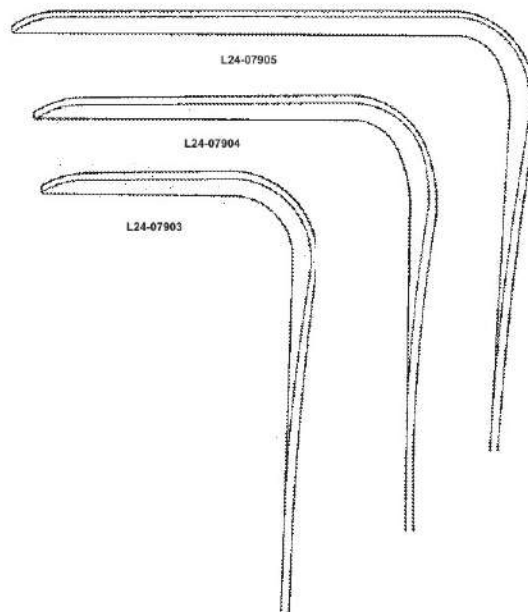

## ●●● Hand Held Retractors



**LANGENBECK BONE HOOK**

**108-0061**  
 205mm (8")  
 Sharp

**LANGENBECK BONE HOOK**

**108-0062**  
 205mm (8")  
 Blunt

**KOCHER BONE HOOK**

**108-0063**  
 220mm (8.3/4")  
 Sharp

**KOCHER BONE HOOK**

**108-0064**  
 220mm (8.3/4")  
 Blunt

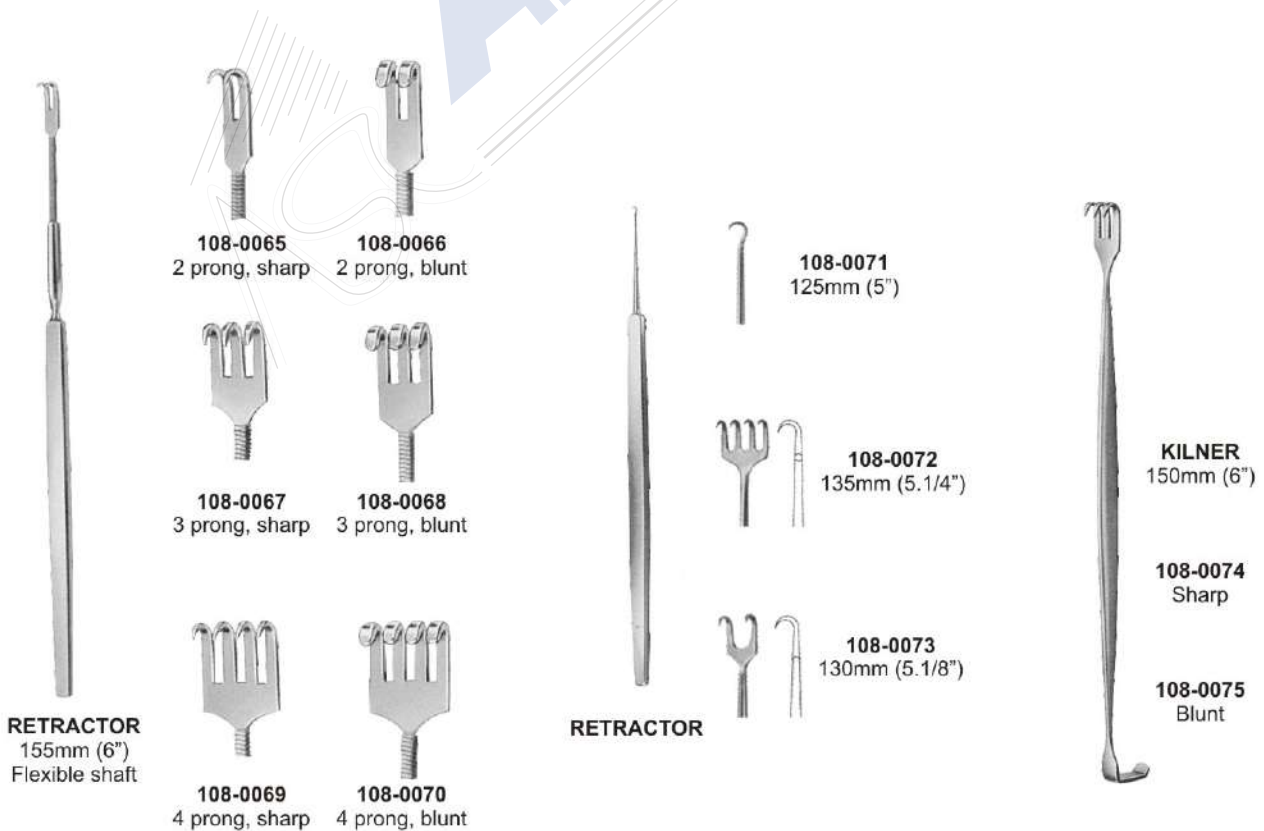

**108-0065**  
 2 prong, sharp

**108-0066**  
 2 prong, blunt

**108-0067**  
 3 prong, sharp

**108-0068**  
 3 prong, blunt

**108-0069**  
 4 prong, sharp

**108-0070**  
 4 prong, blunt

**108-0071**  
 125mm (5")

**108-0072**  
 135mm (5.1/4")

**108-0073**  
 130mm (5.1/8")

**RETRACTOR**  
 155mm (6")  
 Flexible shaft

**RETRACTOR**

**KILNER**  
 150mm (6")

**108-0074**  
 Sharp

**108-0075**  
 Blunt

## Hand Held Retractors ●●●



**RICARD**  
**108-0076**  
Lateral blades: 58mm x 80mm  
Centre blade: 54mm x 70mm  
**108-0077**  
Lateral blades: 72mm x 84mm  
Centre blade: 72mm x 90mm

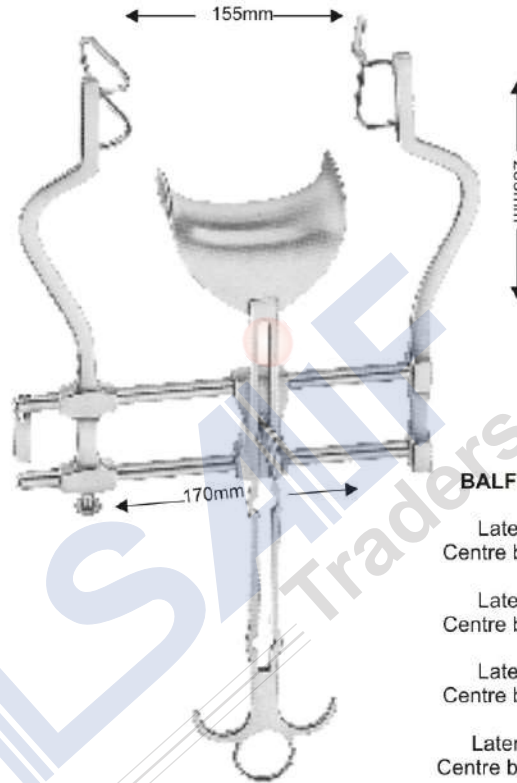

**BALFOUR ABDOMINAL**  
**108-0078**  
Lateral blades: 60mm  
Centre blade: 47mm x 80mm  
**108-0079**  
Lateral blades: 60mm  
Centre blade: 62mm x 76mm  
**108-0080**  
Lateral blades: 90mm  
Centre blade: 80mm x 80mm  
**108-0081**  
Lateral blades: 105mm  
Centre blade: 59mm x 107mm

**KIRSCHNER RETRACTOR SET**  
**108-0082**

Set comprising of:  
1 x **108-0083**  
2 x **108-0084**  
2 x **108-0085**

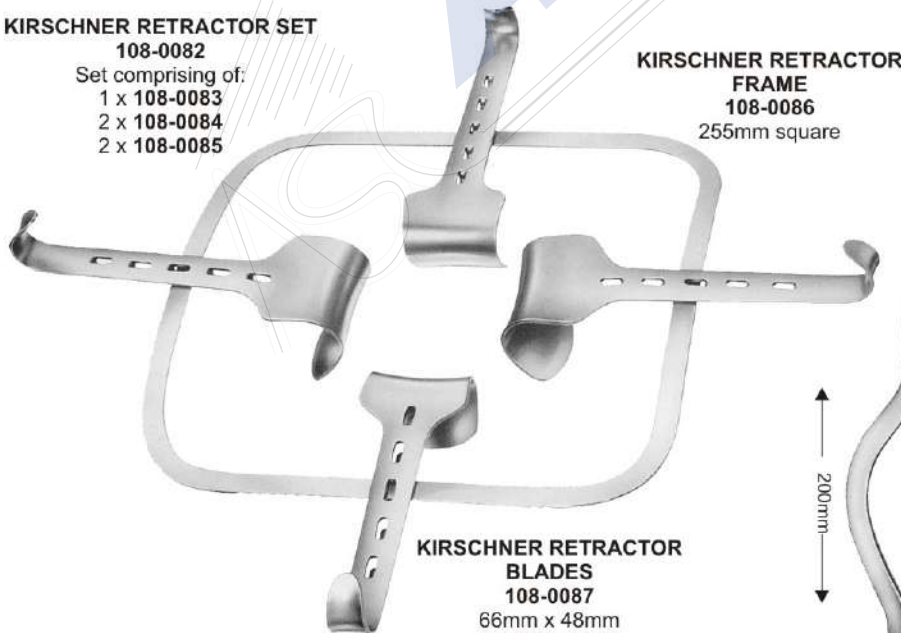

**KIRSCHNER RETRACTOR**  
**FRAME**  
**108-0086**  
255mm square

**KIRSCHNER RETRACTOR**  
**BLADES**  
**108-0087**  
66mm x 48mm  
**108-0088**  
54mm x 42mm  
**108-0089**  
64mm x 80mm

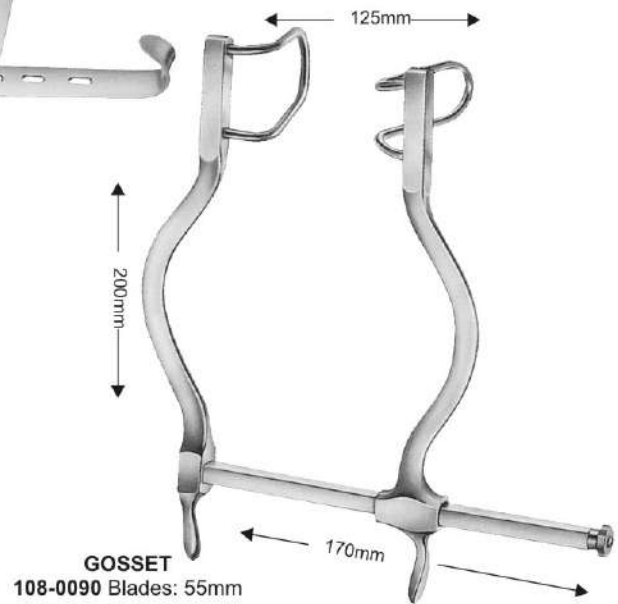

**GOSSET**  
**108-0090** Blades: 55mm

## ●●● Hand Held Retractors



**GOLIGHER**

**108-0091**  
 Complete with two centre blades: 51mm deep, and four lateral blades:  
 2 x 51mm deep  
 2 x 102mm deep

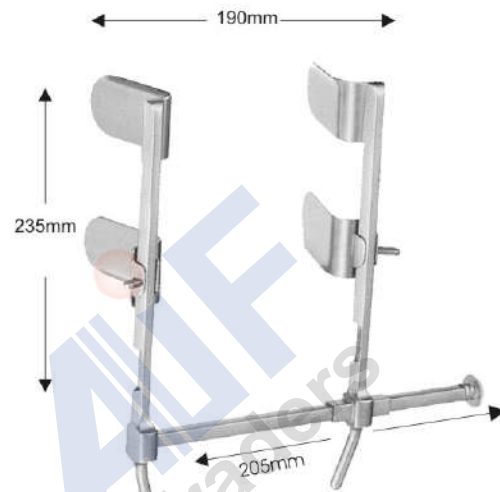

**BERKELEY ABDOMINAL**

**108-0092**  
 Blades: 35mm x 60mm



**TRAVERS**

**108-0093**  
 200mm (8")  
 4 x 5 teeth  
 Blunt



**IRWIN**

**108-0094**  
 178mm (7")  
 4 x 5 teeth  
 Sharp





**WEISLANDER**  
**108-0095** 110mm (4.3/8")  
 2 x 3teeth, sharp



**WEISLANDER**  
**108-0096** 110mm (4.3/8")  
 2 x 3 teeth, blunt



**RNTNE HOSPITAL**  
**108-0097** 159mm (6.1/4")  
 3 x 4 teeth



**NORFOLK AND NORWICH**  
**108-0098** 215mm (8.1/2")  
 4 x 5 teeth, blunt



**WEISLANDER**  
 3 x 4 teeth, blunt  
**108-0099**  
 130mm (5.1/8")  
**108-0100**  
 156mm (6.1/2")



**WEISLANDER**  
 3 x 4 teeth, sharp  
**108-0101**  
 130mm (5.1/8")  
**108-0102**  
 165mm (6.1/2")



**WEISLANDER**  
 3 x 4 teeth, semi sharp  
**108-0103**  
 130mm (5.1/8")  
**108-0104**  
 165mm (6.1/2")

## ●●● Hand Held Retractors



**WEISLANDER**



**108-0105**  
 195mm (7.3/4")  
 3 x 4 teeth  
 sharp



**108-0106**  
 240mm (9.1/2")  
 3 x 4 teeth  
 sharp

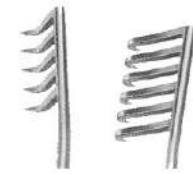

**108-0107**  
 255mm (10")  
 5 x 6 teeth  
 sharp



**108-0108**  
 195mm (7.3/4")  
 3 x 4 teeth  
 blunt



**108-0109**  
 240mm (9.1/2")  
 3 x 4 teeth  
 blunt



**108-0110**  
 255mm (10")  
 5 x 6 teeth  
 blunt

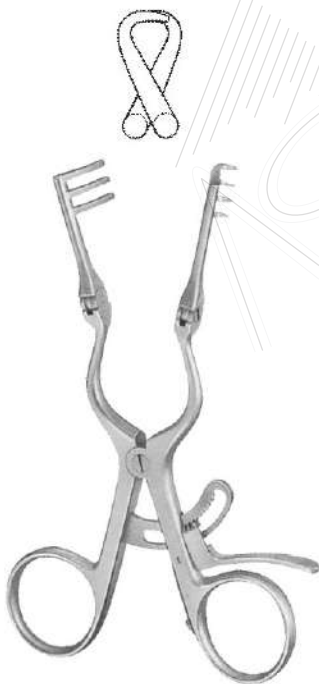

**CONE**

**108-0111**  
 145mm (5.3/4")



**JANSON (SHEA)**

**108-0112**  
 105mm (4.1/8")

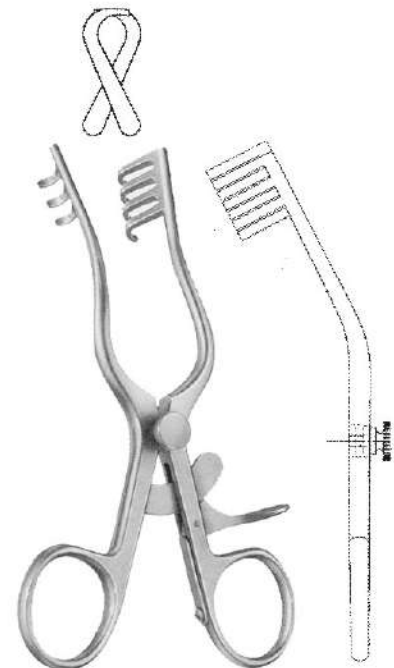

**JEFFERSON**

**108-0113**  
 140mm (5.1/2")



**GEARY GRANT**

**109-0001**  
 230mm (9")  
 Large curved

**LAHEY**

**109-0002**  
 195mm (7.3/4")

**109-0003**  
 230mm (9")

**LOWER**

**109-0004**  
 180mm (7")

**MIXTER**

**109-0005**  
 220mm (8.3/4")

**109-0006**  
 250mm (10")

●●● Cholecystectomy & Gall Stone

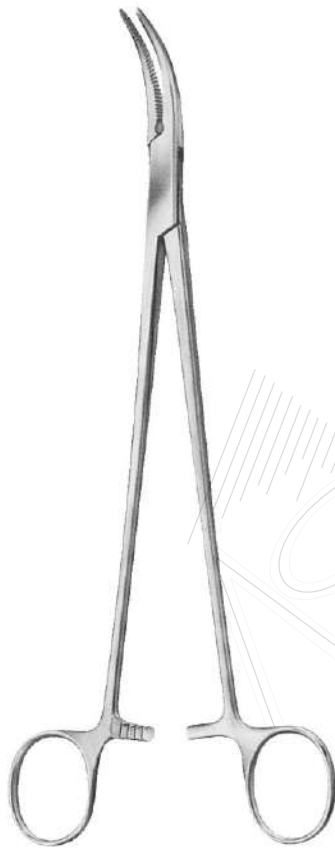
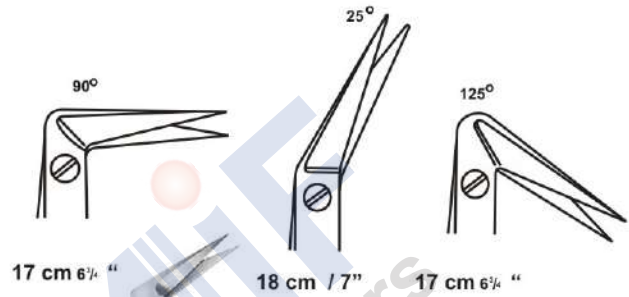

**MOYNIHAN**  
 109-0007  
 230mm (9")

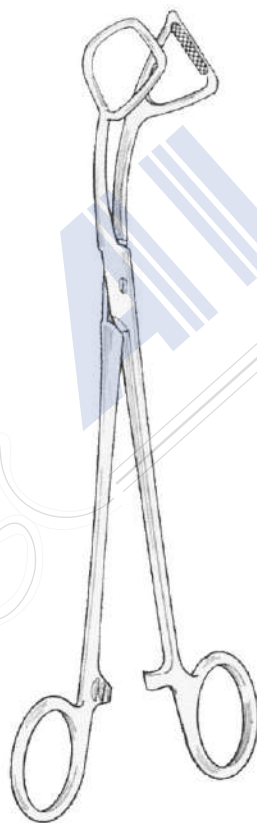

**MOUAT GALL BLADDER LIFTING FORCEPS**  
 109-0008  
 215mm (8.1/2")

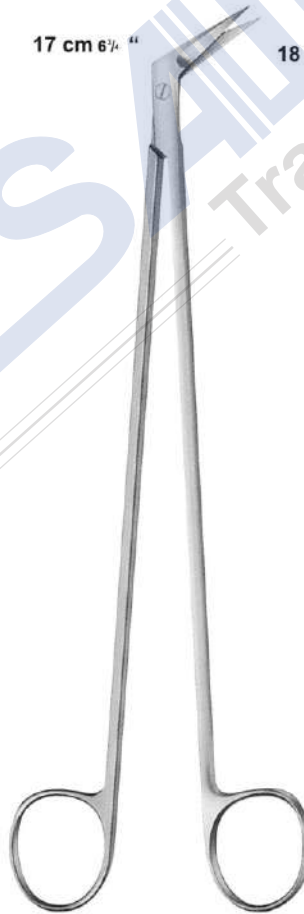

**GALL DUCT SCISSORS**



**POTTS-DE MARTEL**  
 109-0009  
 220mm (8.3/4")



**MILLS**  
 109-0010  
 230mm (8.3/4")

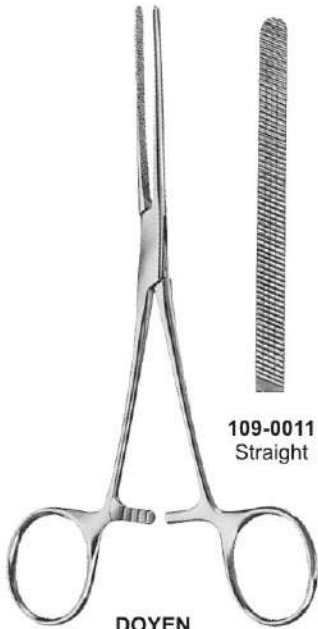

**DOYEN**  
165mm (6.1/2")  
Spring blades

**109-0011**  
Straight



**109-0012**  
Curved



**109-0015**  
Straight

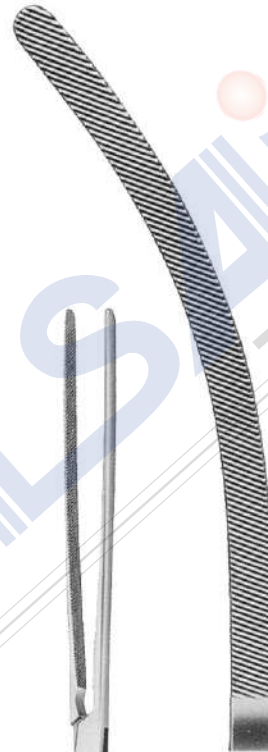

**109-0016**  
Curved



**DOYEN**  
170mm (6.3/4")  
Spring blades

**109-0013**  
Straight

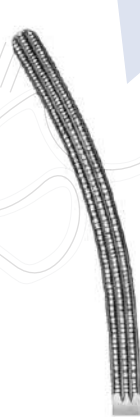

**109-0014**  
Curved

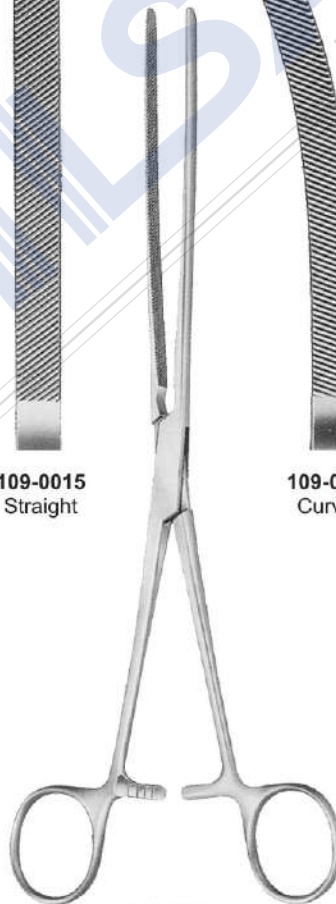

**DOYEN**  
235mm (9.3/4")  
Spring blades

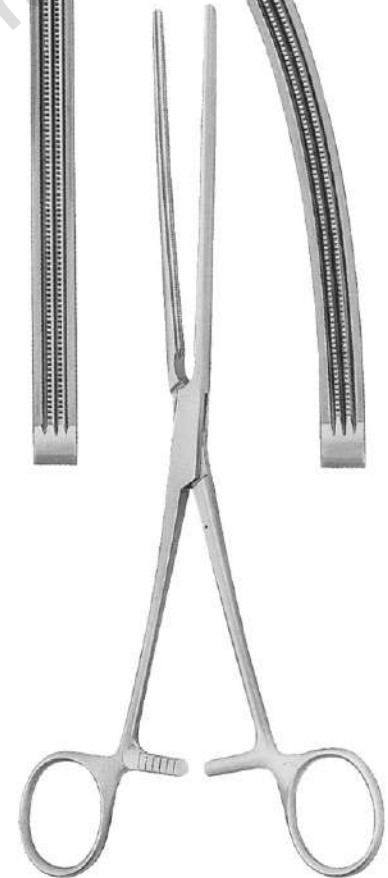

**DOYEN**  
230mm (9")  
Spring blades  
**109-0017** Straight  
**109-0018** Curved

## ● ● ● Intestinal Clamps



**DOYEN (KOCHER)**  
Straight, light spring blade  
**109-0019**  
230mm (9")  
**109-0020**  
250mm (10")  
**109-0021**  
280mm (11")  
**109-0022**  
210mm (8.1/4")

**DOYEN (MAYO ROBSON)**  
Curved, light spring blade  
**109-0023**  
230mm (9")  
**109-0024**  
250mm (10")  
**109-0025**  
280mm (11")  
**109-0026**  
210mm (8.1/4")

**KOCHER**  
Spring blades  
**109-0027**  
250mm (10")  
**109-0028**  
280mm (11")

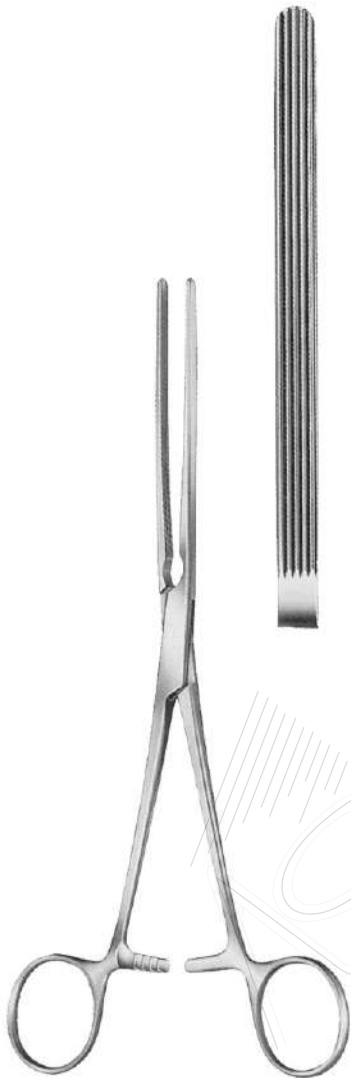

**LANE**  
**109-0029**  
 210mm (8.1/4")

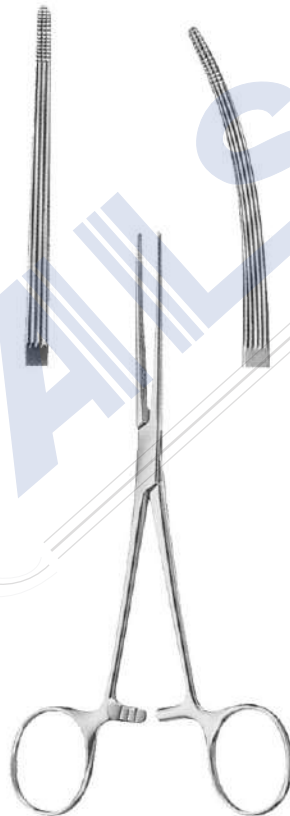

**SETON PRINGLE**  
**(BAINBRIDGE)**  
**109-0030**  
 150mm (6") Straight  
**109-0031**  
 150mm (6") Curved

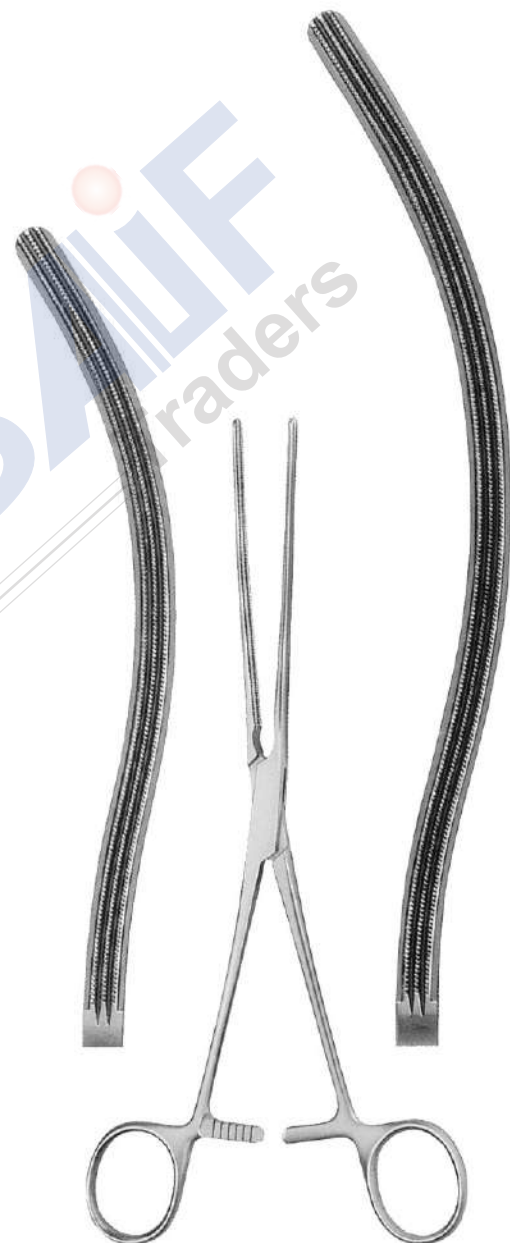

**DOYEN (MAYO ROBSON)**  
 Spring blades  
**109-0032**  
 250mm (10")  
**109-0033**  
 280mm (11")

## ● ● ● Intestinal Clamps



**SCHOEMAKER**  
 Hollow blades for  
 hemisphincterectomy  
**109-0034**  
 170mm (6.3/4")  
**109-0035**  
 215mm (8.1/2")

**PARKER KERR**  
 Anastomosis forceps for  
 colon resection  
**109-0036**  
 250mm (10")

**LANG STEVENSON**  
**109-0037**  
 200mm (8")

**PAYR**  
**109-0038**  
 200mm (8")  
 Jaw: 65mm  
**109-0039**  
 280mm (11")  
 Jaw: 100mm  
**109-0040**  
 350mm (14")  
 Jaw: 150mm



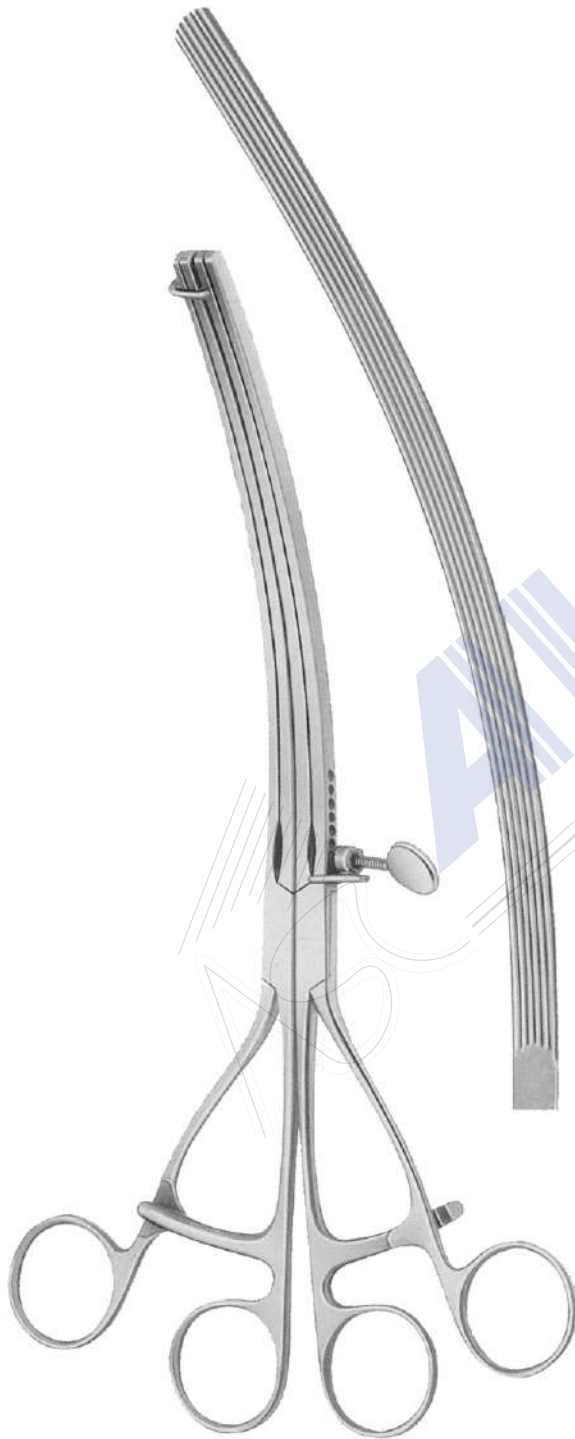

**LANE TWIN ANASTOMOSIS**  
**109-0041**  
300mm (12") Curved

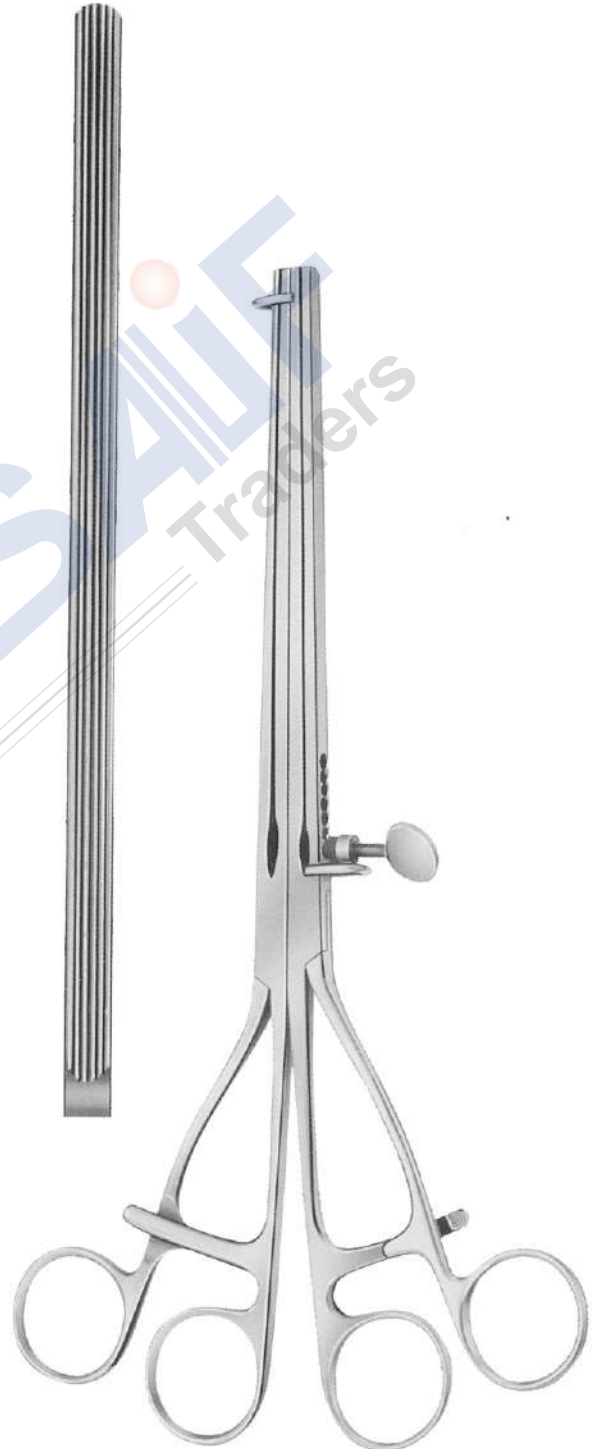

**LANE TWIN ANASTOMOSIS**  
**109-0042**  
300mm (12") Straight

## ●●● Vaginal Speculum



**CUSSO**  
110-0001 75mm x 17mm  
Extra small for virgins

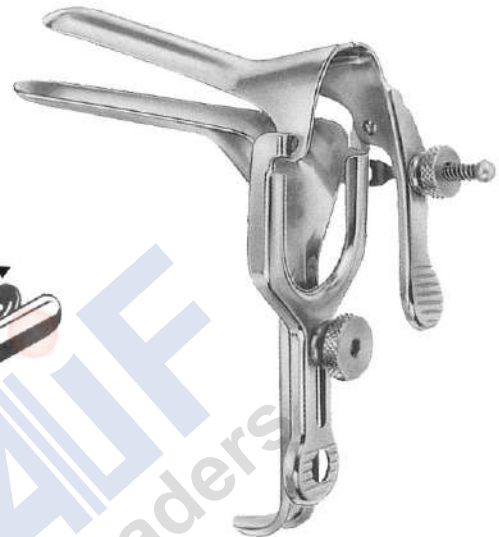

**GRAVE**  
110-0004 75mm x 20mm  
110-0005 95mm x 30mm  
110-0006 195mm x 33mm

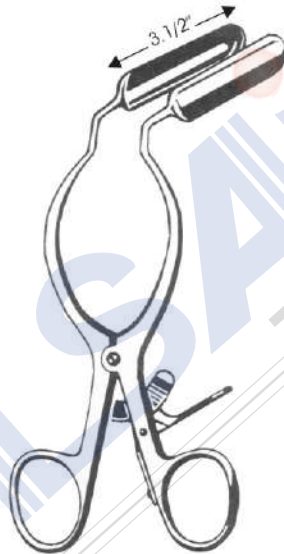

**McGEE LATERAL  
VAGINAL RETRACTOR**  
with ratch handle  
110-0003

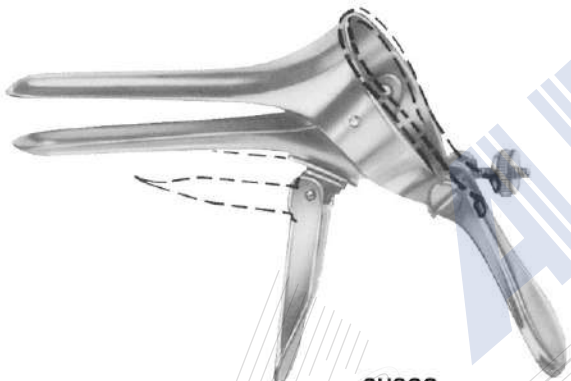

**CUSCO**  
110-0002 75mm x 17mm  
Extra small for virgins



**CUSCO**  
110-0007 110mm x 37mm  
110-0008 80mm x 32mm  
110-0009 80mm x 24mm



**PEDERSON**  
110-0010 100mm x 22 mm  
110-0011 120mm x 25mm

## Vaginal Speculum ●●●

**SIMS**

- 111-0001**  
125mm (5")  
Small  
70mm x 26mm  
75mm x 30mm
- 111-0002**  
150mm (6")  
Medium  
75mm x 30mm  
80mm x 35mm
- 111-0003**  
175mm (7")  
Large  
80mm x 36mm  
90mm x 40mm

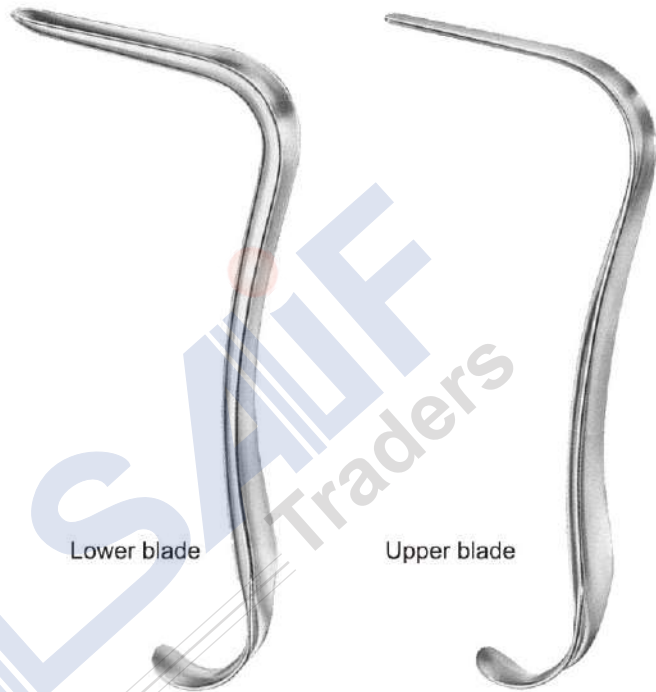
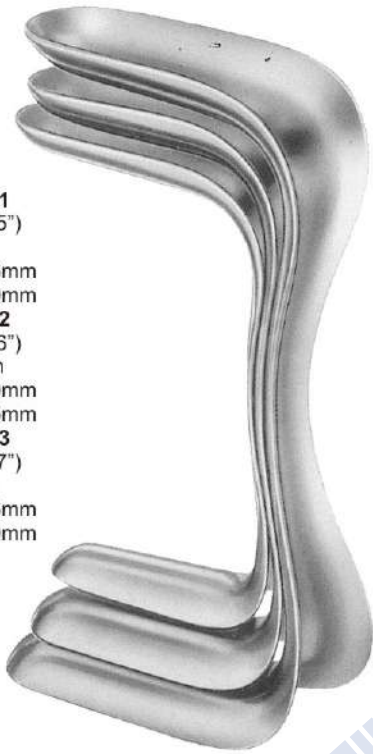

Lower blade

Upper blade

- 111-0004**  
175mm (7")  
Blade:  
70mm x 15mm

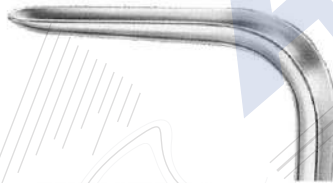

- 111-0008**  
175mm (7")  
Blade:  
70mm x 10mm



- 111-0005**  
180mm (7")  
Blade:  
70mm x 27mm

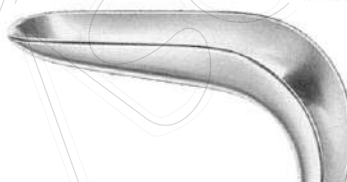

- 111-0009**  
180mm (7")  
Blade:  
75mm x 23mm



- 111-0006**  
180mm (7")  
Blade:  
75mm x 30mm

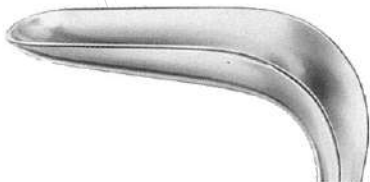

- 111-0010**  
180mm (7")  
Blade:  
80mm x 25mm



- 111-0007**  
185mm (7.1/4")  
Blade:  
90mm x 36mm

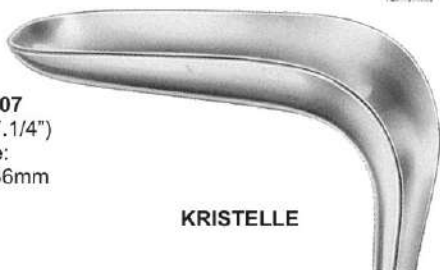

KRISTELLE

- 111-0011**  
185mm (7.1/4")  
Blade:  
100mm x 32mm



KRISTELLE

## ●●● Vaginal Speculum

### MATHIEU

**111-0012**  
210mm (8.1/4")  
Blade:  
95mm x 17-30mm  
For children and virgins



### DOYEN

240mm (9.1/2")

**111-0013**  
Blade: 60mm x 35mm

**111-0014**  
Blade: 90mm x 35mm

**111-0015**  
Blade: 120mm x 35mm

**111-0016**  
Blade: 60mm x 60mm

**111-0017**  
Blade: 90mm x 60mm

**111-0018**  
Blade: 120mm x 60mm

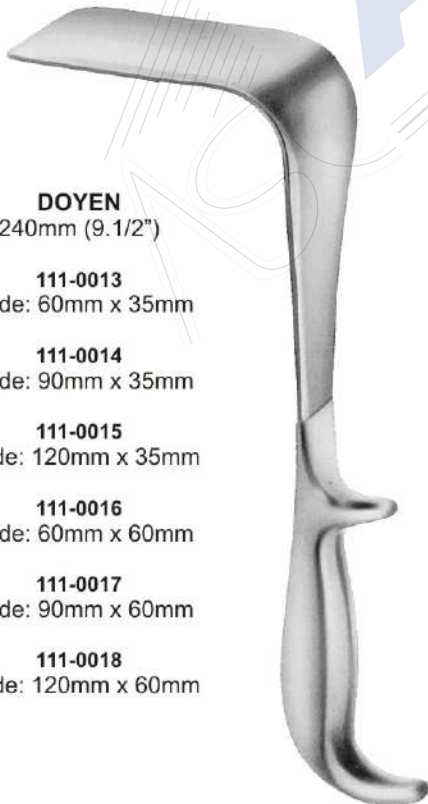

### MODIFIED WERTHEIM

320mm (12.3/4")

**111-0019**  
Blade: 100mm x 25mm

**111-0020**  
Blade: 100mm x 30mm

**111-0021**  
Blade: 100mm x 35mm

**111-0022**  
Blade: 100mm x 40mm

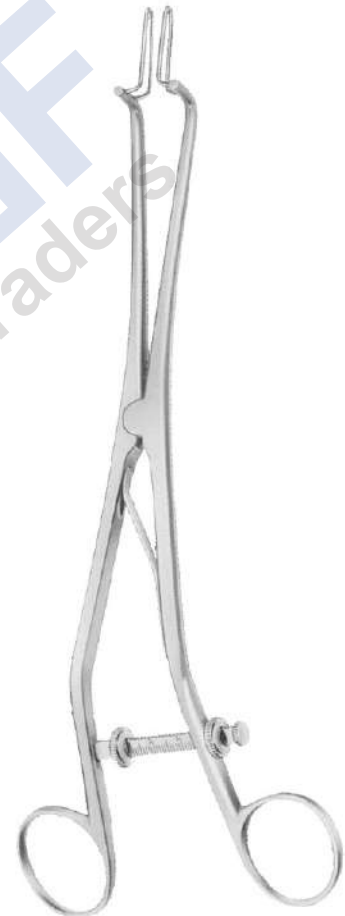

### KOGAN ENDOCERVICAL SPECULUM

**111-0023**  
240mm (9.1/2")  
Graduated

## Vaginal Retractor/ Uterine Dilators ●●●

### AUVARD

**111-0024**  
230mm (9")  
Blade: 63mm x 38-28mm  
Weight: 1.53 Kg (3lb, 60z)  
Fixed weight



### AUVARD

230mm (9")  
Weight: 1.47kg (3lb, 4oz)  
with detachable weight

**111-0025**  
Blade: 75mm x 42-40mm

**111-0026**  
Blade: 105mm x 43-40mm

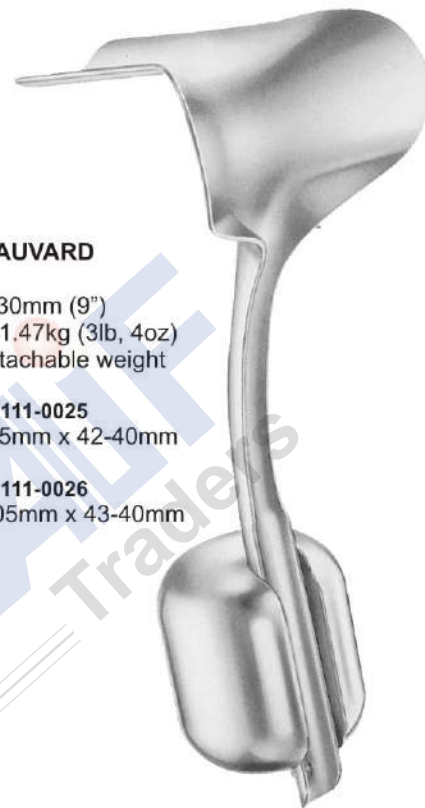

### O6-09443

Set of twelve

- 111-0027** 6mm
- 111-0028** 7mm
- 111-0029** 8mm
- 111-0030** 9mm
- 111-0031** 10mm
- 111-0032** 11mm
- 111-0033** 12mm
- 111-0034** 13mm
- 111-0035** 14mm
- 111-0036** 15mm
- 111-0037** 16mm
- 111-0038** 17mm



**HAWKIN AMBLER**  
170mm (6.3/4")  
Cervix dilator

### 111-0039

Set of sixteen  
consisting of one of  
each of: 111-0040 to 111-0056

- |                      |                       |                        |
|----------------------|-----------------------|------------------------|
| <b>111-0040</b> 2mm  | <b>111-0052</b> 13mm  | <b>111-0063</b> 8.5mm  |
| <b>111-0042</b> 3mm  | <b>111-0053</b> 14mm  | <b>111-0064</b> 9.5mm  |
| <b>111-0043</b> 4mm  | <b>111-0054</b> 15mm  | <b>111-0065</b> 10.5mm |
| <b>111-0044</b> 5mm  | <b>111-0055</b> 16mm  | <b>111-0066</b> 11.5mm |
| <b>111-0045</b> 6mm  | <b>111-0056</b> 17mm  | <b>111-0067</b> 12.5mm |
| <b>111-0046</b> 7mm  | <b>111-0057</b> 2.5mm | <b>111-0068</b> 13.5mm |
| <b>111-0047</b> 8mm  | <b>111-0058</b> 3.5mm | <b>111-0069</b> 14.5mm |
| <b>111-0048</b> 9mm  | <b>111-0059</b> 4.5mm | <b>111-0070</b> 15.5mm |
| <b>111-0049</b> 10mm | <b>111-0060</b> 5.5mm | <b>111-0071</b> 16.5mm |
| <b>111-0050</b> 11mm | <b>111-0061</b> 6.5mm | <b>111-0072</b> 17.5mm |
| <b>111-0051</b> 12mm | <b>111-0062</b> 7.5mm |                        |



**HEGAR**  
185mm (7.1/4")  
Cervix dilator

● ● ● Uterine Dilators / Probes



**HEGAR**  
205mm (8")  
Cervix dilator  
Double ended

**111-0073**  
Set of eight consisting  
of one of each of:  
111-0074 to 111-0082

- 111-0074      1mm - 2mm
- 111-0075      3mm - 4mm
- 111-0076      5mm - 6mm
- 111-0077      7mm - 8mm
- 111-0078      9mm - 10mm
- 111-0079      11mm - 12mm
- 111-0080      13mm - 14mm
- 111-0081      15mm - 16mm
- 111-0082      17mm - 18mm

4mm



**GALABIN**

**111-0083**  
290mm (11.1/2")  
Shaft graduated  
is cm's  
Malleable

3mm



**SIMS**

**111-0084**  
330mm (13")

**111-0085**  
330mm (13")  
Malleable



**MARTIN**

**111-0086**  
300mm (12")



**111-0087**  
HEGAR  
Dilator set consisting of:  
14 Dilators,  
1 Rack for dilators ( 4- 12 mm)  
1 Rack for Dilators ( 13 - 17 mm)  
1 Metal case only,  
with hinged lid, stainless 200 X 100 X 35 mm

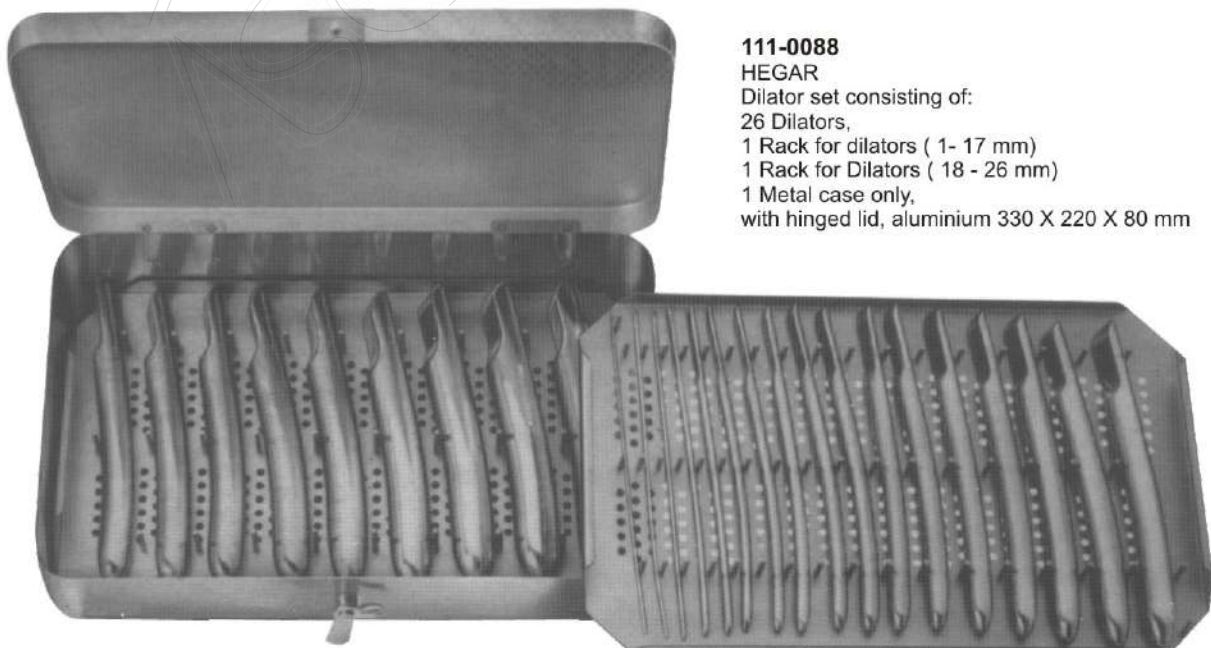

**111-0088**  
HEGAR  
Dilator set consisting of:  
26 Dilators,  
1 Rack for dilators ( 1- 17 mm)  
1 Rack for Dilators ( 18 - 26 mm)  
1 Metal case only,  
with hinged lid, aluminium 330 X 220 X 80 mm

## ●●● Tenaculum Forceps

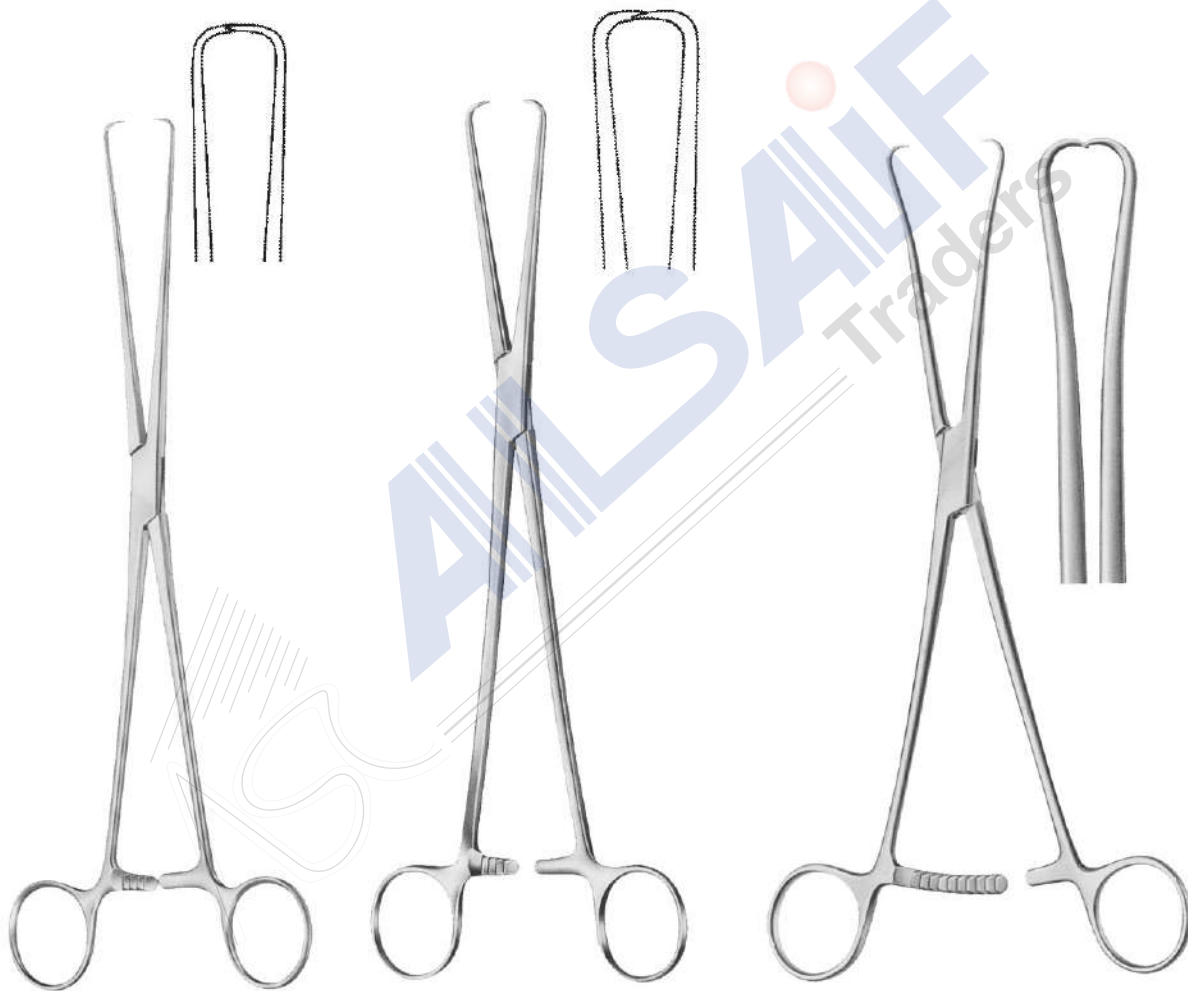

### **BROWN**

**112-0001**  
250mm (10")  
Slender

### **SCHROEDER**

**112-0002**  
230mm (9")

### **WILSON**

**112-0003**  
240mm (9.1/2")



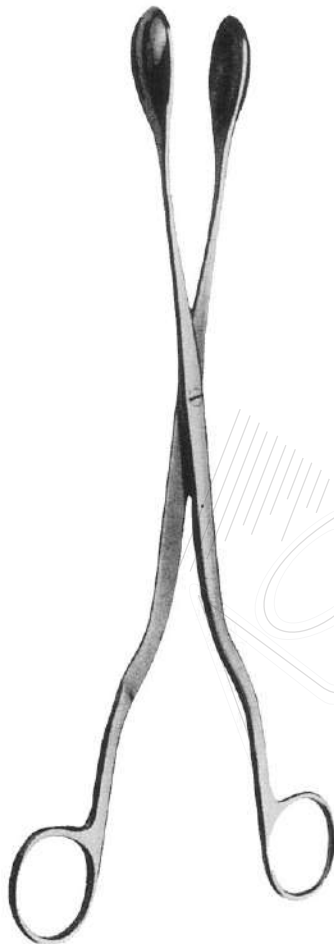

**HEYWOOD SMITH**

**112-0004**  
240mm (9.1/2")

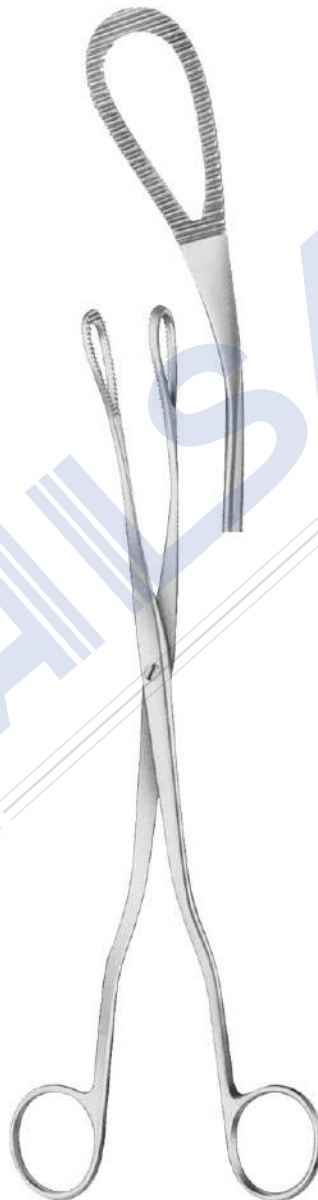

**MCLINTOCK**

**112-0005**  
240mm (9.1/2")

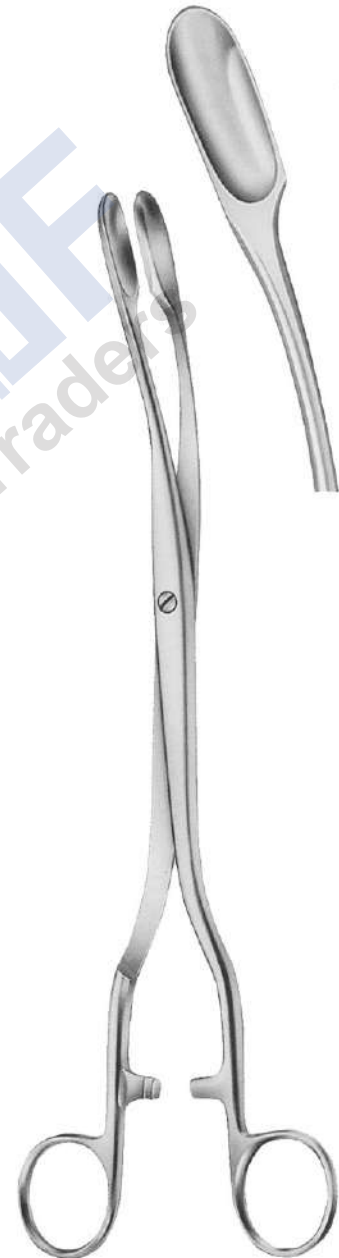

**NOTO**

**112-0006**  
280mm (11")

## ●●● Ovum Forceps

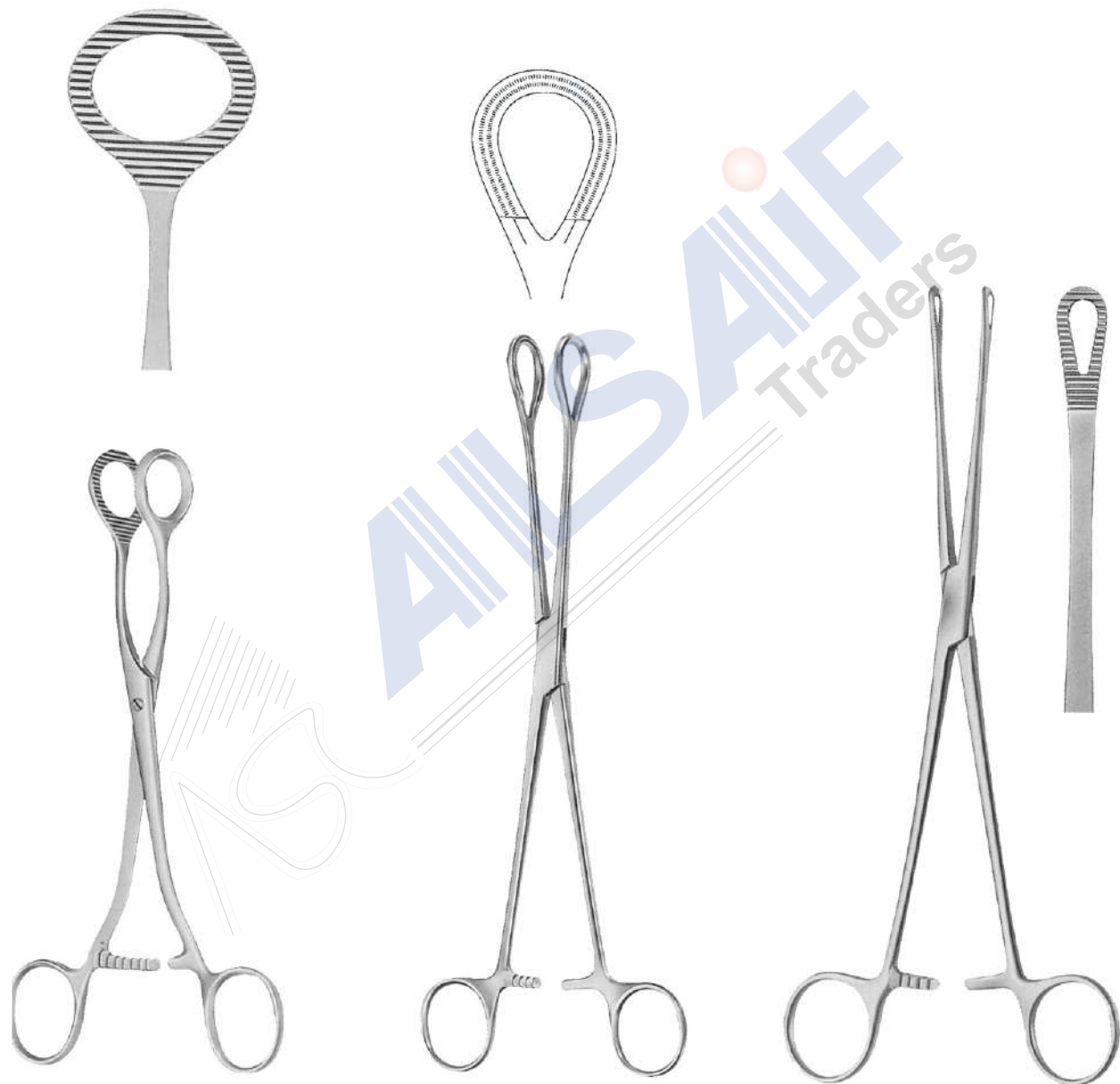

**DOYEN**  
**112-0007**  
185mm (7.1/4")

**112-0008**  
250mm (10")

**BONNEY POLYPI**  
**112-0009**  
240mm (9.1/2")

## Cervical Biopsy Forceps ●●●

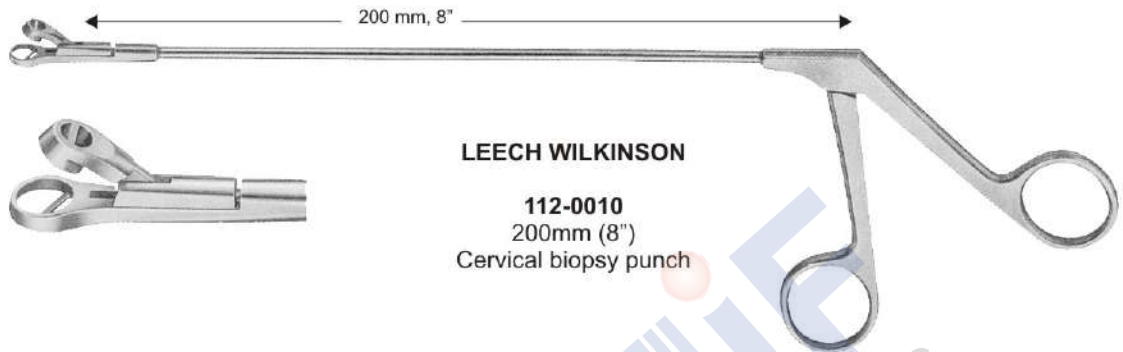

**LEECH WILKINSON**  
**112-0010**  
200mm (8")  
Cervical biopsy punch

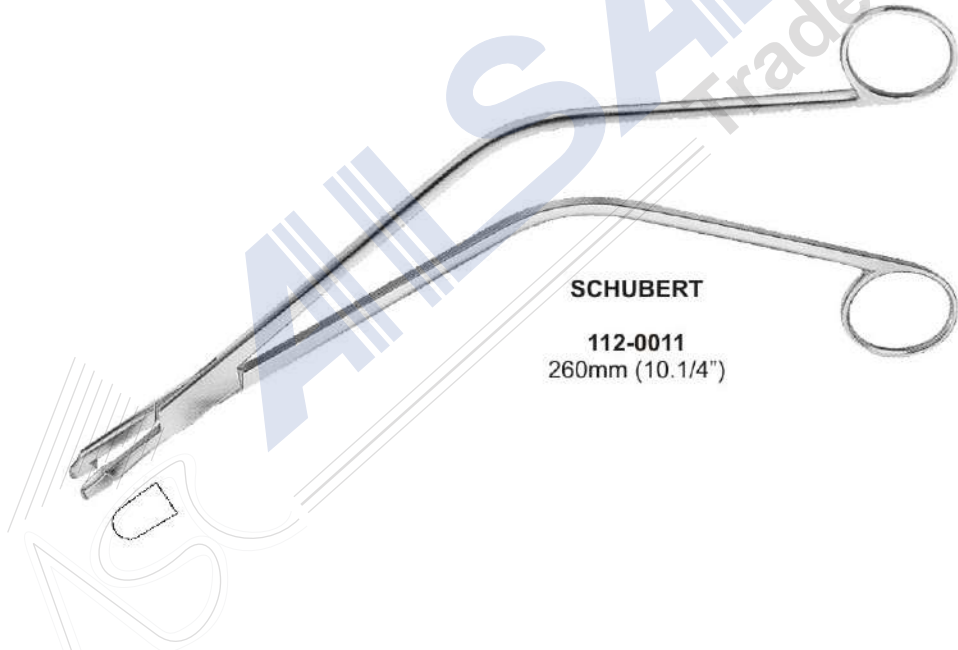

**SCHUBERT**  
**112-0011**  
260mm (10.1/4")

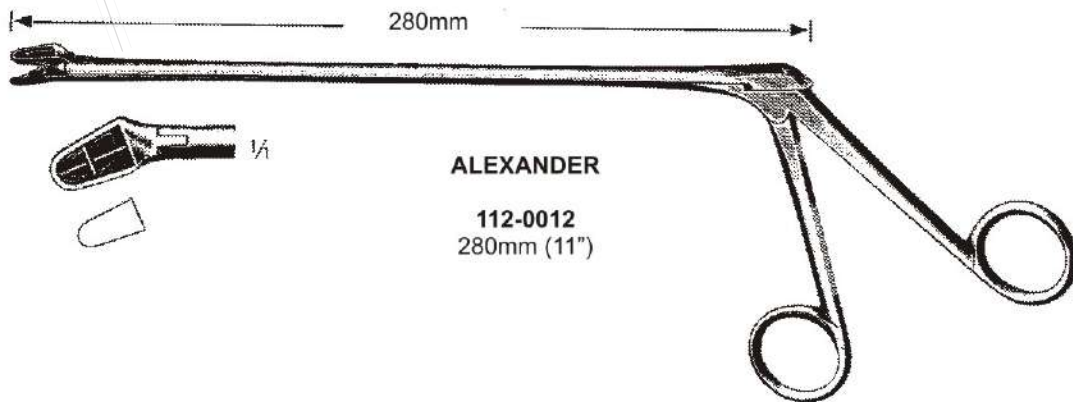

**ALEXANDER**  
**112-0012**  
280mm (11")

## ●●● Cervical Biopsy Forceps

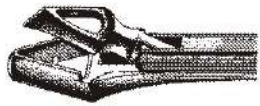

240mm

### SCHUMARCHER

112-0013  
240mm (9.1/2")



235mm

### KEVORKIAN

112-0014  
235mm (9.3/4")



230mm

### WITTNER

112-0015  
230mm (9.1/4") Straight  
230mm (9.1/4") Curved



200mm

### TISCHLER-MORGAN

112-0016  
200mm (8")

## Uterine Scoops And Curettes ●●●

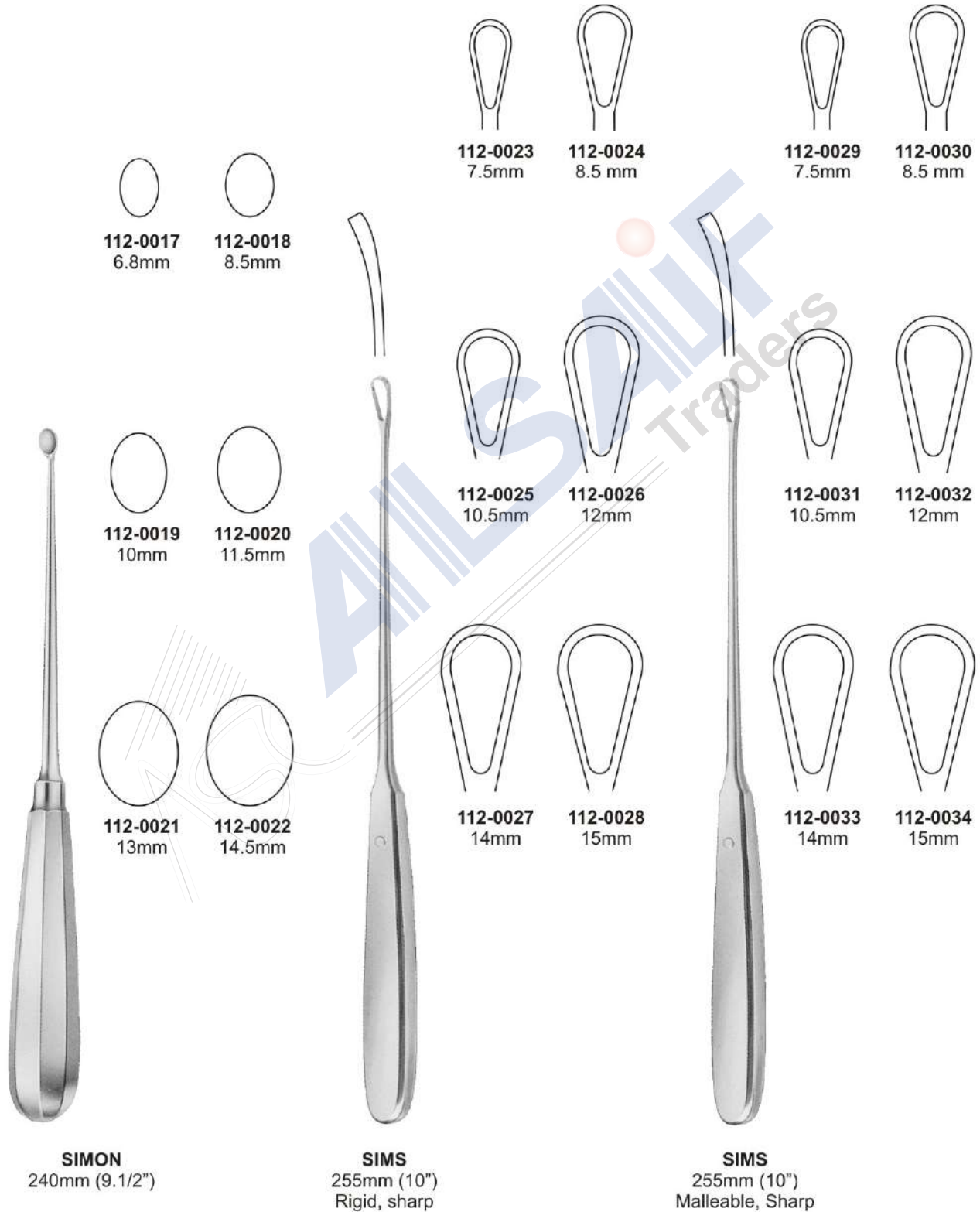

## ● ● ● Uterine Curettes

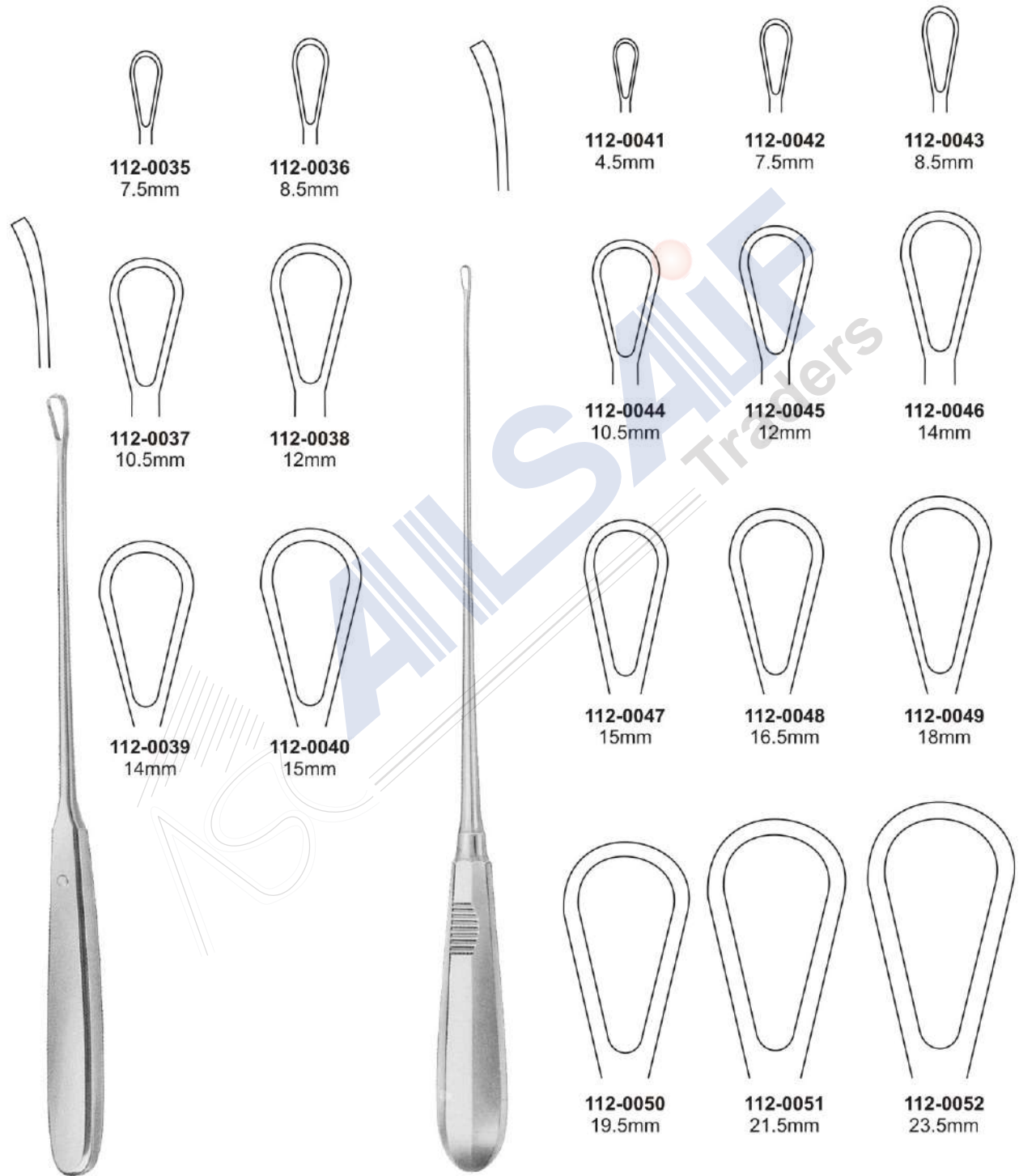

**SIMS**  
255mm (10")  
Malleable, blunt

300mm (12")  
Sharp

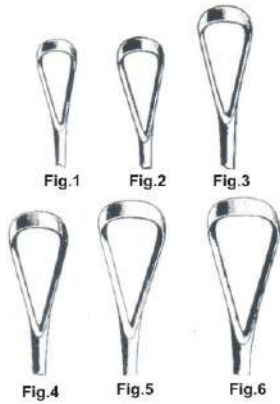

**SIMS**  
 112-0053  
 280mm (11")



**RECAMIER**  
 112-0054  
 310mm (13")



**BUMM**  
 112-0055  
 280mm (11")

● ● ● Obstetrics Instruments

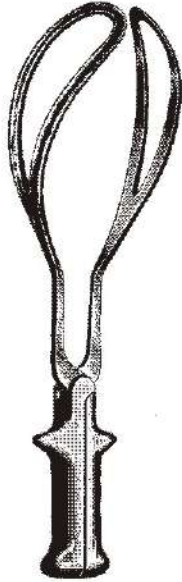

**SIMPSON**  
 112-0056 300mm  
 (12")

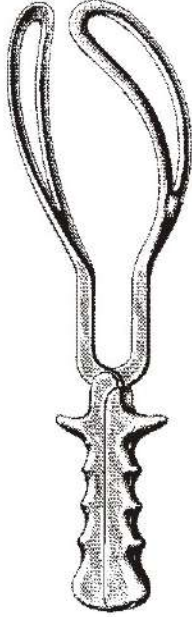

**SIMPSON-BRAUN**  
 112-0057 330mm  
 (13")

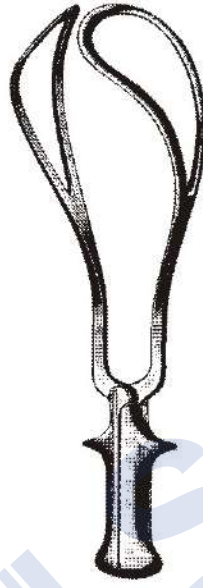

**De LEE**  
 112-0058 300mm  
 (12")



**De LEE**  
 112-0059 360mm  
 (14.1/2")



**ELLIOT**  
 112-0060 320mm  
 (12.1/2")

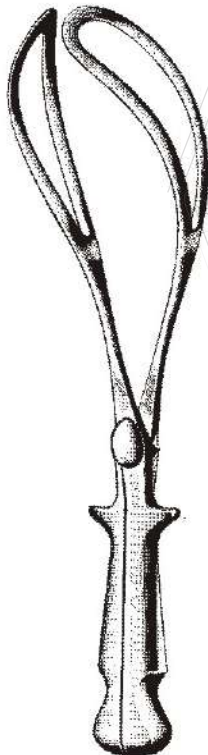

**NAEGELE**  
 112-0061  
 360mm (14.1/2")



**I.U.D. REMOVING HOOK**  
 112-0062 320mm (12.1/2")

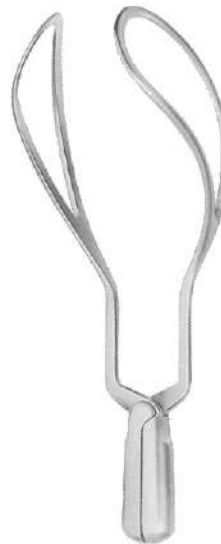

**WRIGLEY**  
 112-0063 250mm (10")



**KIELLAND**  
 112-0064 402mm (16.3/4")



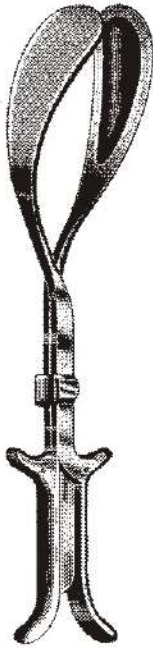

**LUIKART**

112-0065  
400mm (16")



**KIELLAND-LUIKART**

112-0066  
400mm (16")



**SIMPSON-LUIKART**

112-0067  
360mm (14.1/2")

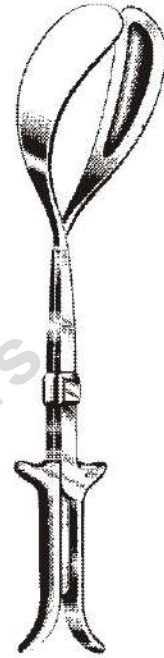

**McLEAN-TUCKER-LUIKART**

112-0068  
400mm (16")

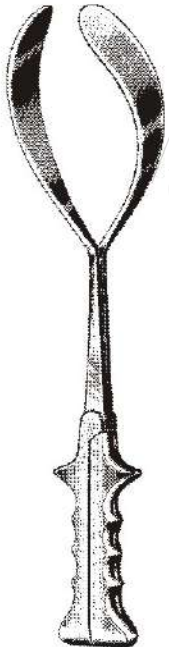

**McLEAN-TUCKER**

112-0069  
390mm (15.1/2")

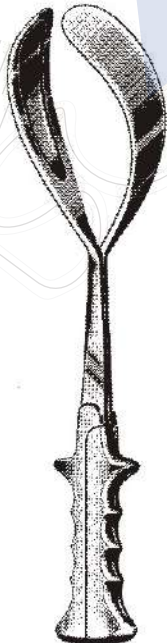

**McLEAN-LUIKART**

112-0070  
390mm (15.1/2")

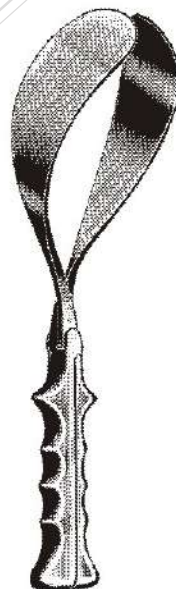

**McLEAN**

112-0071  
360mm (14.1/2")

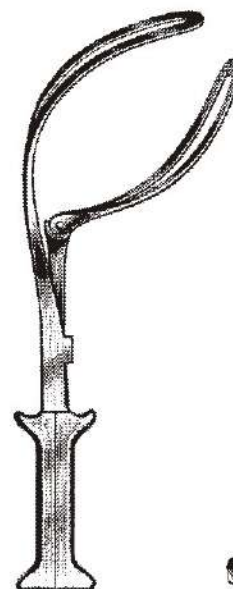

**BARTON**

112-0072  
360mm (14.1/2")

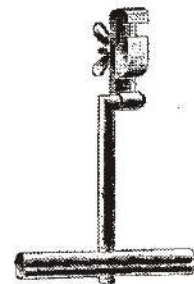

**BARTON**

112-0073  
170mm (6.3/4")

## ●●● Dermatology, Gynecology Instruments



**GREEN - ARMYTAGE  
HEAMOSTASIS FORCEPS**  
**113-0001**  
200mm (8") Straight  
**113-0002**  
195mm (7.3/4") Angled



**WINTER OVUM FORCEPS**  
290mm (11.1/2")



**113-0003**



**113-0004**



**113-0005**



**SAENGER OVUM FORCEPS**  
**113-0006**  
275mm (10.3/4")



**UMBILICAL DILATOR**  
**113-0007**  
95mm (3.3/4")

## Peritoneum, Hysterectomy Clamps ●●●

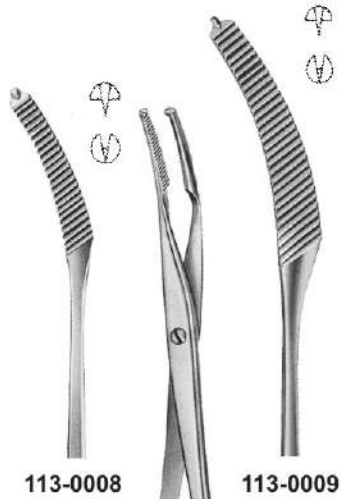

113-0008 113-0009

**MIKULICZ**  
113-0008 180mm (7")  
113-0009 205mm (8")



113-0010 113-0011

**PEROTONEUM**  
113-0010 205mm (8")  
113-0011 205mm (8")

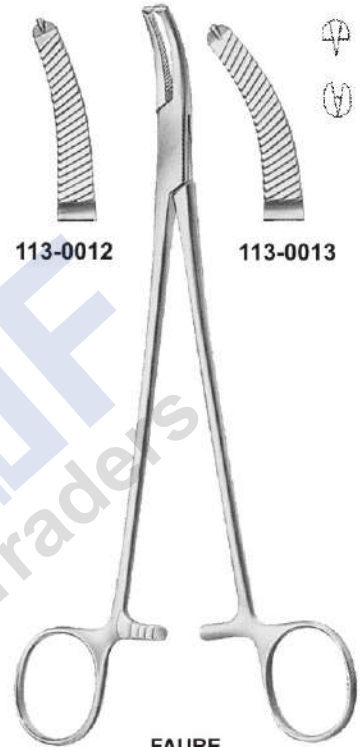

113-0012 113-0013

**FAURE**  
113-0012 205mm (8")  
113-0013 205mm (8")

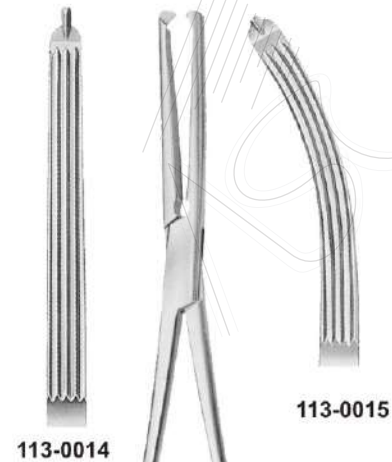

113-0014 113-0015

**GWILLIAM**  
**HYSTERECTOMY** 200mm (8")  
113-0014 Straight  
113-0015 Curved



113-0016

**HEANY**  
**HYSTERECTOMY FORCEPS** 200m (8")  
113-0016 Curved, single tooth

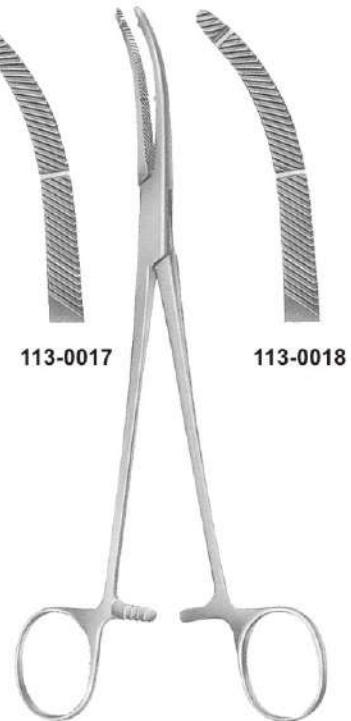

113-0017 113-0018

**HEANY**  
113-0017 205mm (8")  
113-0018 245cm (9.3/4")

## ●●● Hysterectomy Clamps



**MAINGOT  
GYSTERECTOMY FORCEPS**  
113-0019 200mm (8")  
Curved, 1 x 2 teeth  
113-0020  
Straight, 1 x 2 teeth  
113-0021 240mm (9.1/2")  
Curved, 1 x 2 teeth



**PHANEUF**  
113-0022 205mm (8")  
Straight, 1 x 2 teeth



**BONNEY**  
113-0023 205mm (8")  
Angled on flat, 1 x 2 teeth

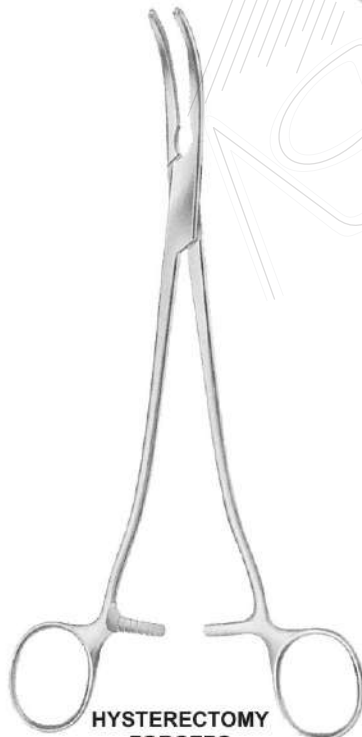

**HYSTERECTOMY  
FORCEPS**  
Atraumatic



**113-0024**  
215mm (8.1/2")



**113-0025**  
205mm (8")



**113-0026**  
220mm (8.3/4")



**113-0027**  
240mm (9.1/2")



**113-0028**  
225mm (9")



**113-0029**  
250mm (10")



**113-0030**  
245mm (9.3/4")



**113-0031**  
230mm (9")

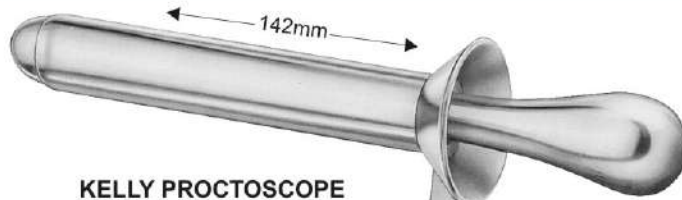

**KELLY PROCTOSCOPE**

**113-0032**  
140mm (5.1/2") Diameter, 22mm

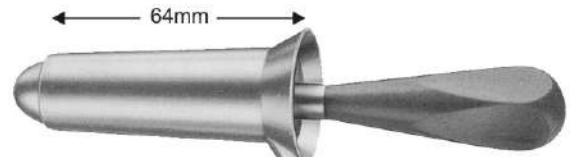

**GABRIEL RECTAL SPECULUM**

**113-0033**  
64mm (2.1/2")  
Diameter: 25mm



**MCEVEDY  
RECTAL SPECULUM  
WITH  
BATTERY HANDLE**  
**113-0034** 150mm (6")  
Diameter: 27mm

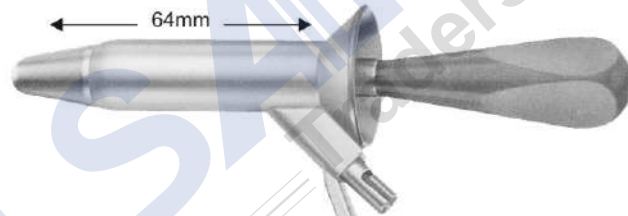

**NAUNTUN MORGAN  
RECTAL SPECULUM**  
165mm (6.1/2")  
**113-0035**  
Diameter: 17mm  
With fibre light carrier  
**113-0036**  
Diameter: 21mm  
With fibre light carrier  
**113-0037**  
Diameter: 24mm  
With fibre light carrier

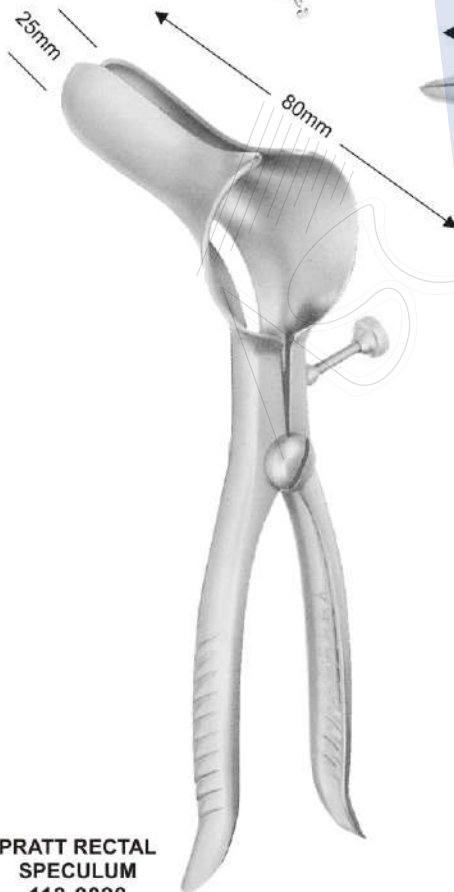

**PRATT RECTAL  
SPECULUM**  
**113-0038**  
205mm (8")

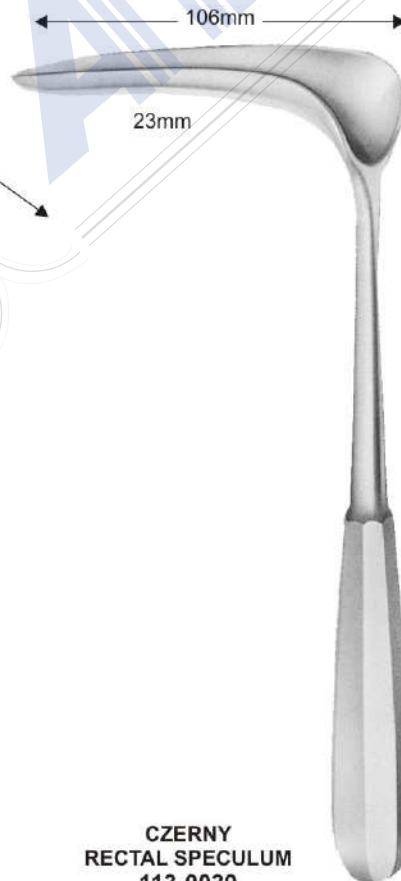

**CZERNY  
RECTAL SPECULUM**  
**113-0039**  
225mm (9")



**SIMS RECTAL  
SPECULUM**  
**113-0040**  
160mm (6.1/4")

●●● Urology



**RANDALL**  
Renal Calculus Forceps

**113-0041**  
A  
230mm (9")



**113-0042**  
B  
200mm (8")



**113-0043**  
C  
195mm (7.3/4")



**113-0044**  
D  
180mm (7")



**MILLIN**  
**113-0045**  
245mm (9.3/4")  
Ligature holding forceps



**BLADDER SPATULA**  
**113-0046** 235mm (9.3/4")  
Blade: 91mm x 61mm

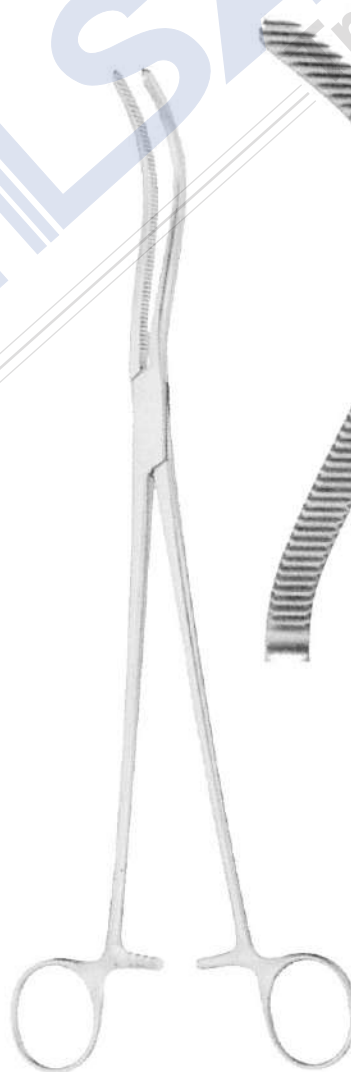

**GUYON**  
**113-0047** 265mm (10.1/2")



**KIDNEY CLAMP**  
**113-0048** 255mm (10")

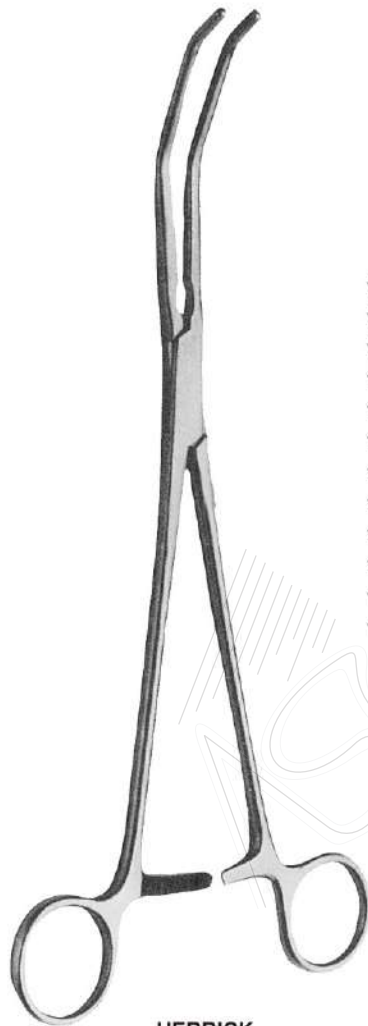

**HERRICK**  
113-0049 225mm (9")

- |          |       |                    |
|----------|-------|--------------------|
| 113-0050 | 6/10  | f.g (2/3.33mm)     |
| 113-0051 | 8/12  | f.g (2.66/4.66mm)  |
| 113-0052 | 10/14 | f.g (3.33/4.66mm)  |
| 113-0053 | 12/16 | f.g (4/5.33mm)     |
| 113-0054 | 14/18 | f.g (4.66/6mm)     |
| 113-0055 | 16/20 | f.g (5.33/6.66mm)  |
| 113-0056 | 18/22 | f.g (6/7.33mm)     |
| 113-0057 | 20/24 | f.g (6.66/8mm)     |
| 113-0058 | 22/26 | f.g (7.33/8.66mm)  |
| 113-0059 | 24/28 | f.g (8/9.33mm)     |
| 113-0060 | 26/30 | f.g (8.66/33mm)    |
| 113-0061 | 28/32 | f.g (9.33/10.66mm) |

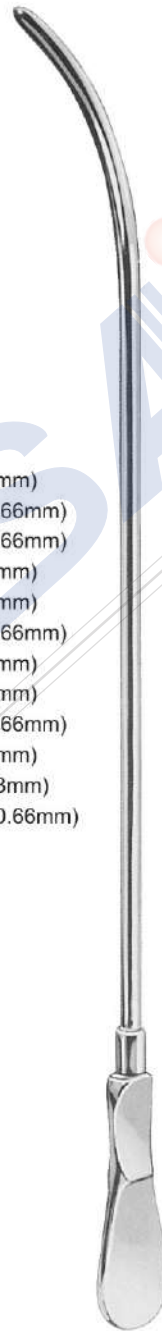

**CLUTTON URETHRAL SOUNDS**  
265mm (10.1/2")  
Set twelve **113-0062**  
Set Comprising one of each of:



**FEMALE CATHETERS**  
160mm (6.1/4")

- |                 |                 |
|-----------------|-----------------|
| <b>113-0062</b> | 12 f.g (4mm)    |
| <b>113-0063</b> | 8 f.g (2.66mm)  |
| <b>113-0064</b> | 10 f.g (3.33mm) |
| <b>113-0065</b> | 14 f.g (4.66mm) |
| <b>113-0066</b> | 16 f.g (5.33mm) |

## ●●● Suction Tubes



**YANKAUER**

**113-0067**  
305mm (12")

**113-0068**  
Rose end



**POOLE**

**113-0069**  
240mm (9.1/2")

**113-0070**  
180mm (7")  
Lawrie extension piece



**113-0071**

**GILLIES**  
170mm (6.3/4")  
Control valve

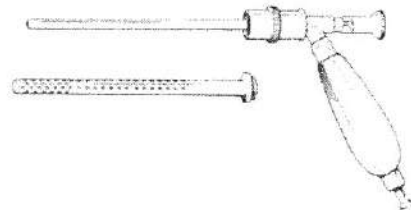

**TINCKLER**  
**(SIMPSON SMITH)**

**113-0072**  
255mm (10")  
With on / off value, removable perforated outer sheath





**BARRON**  
**113-0073**  
230mm (9")  
Diameter: 1.33mm



**FRAZIER**  
**113-0074**  
185mm (7.1/4") Diameter 2.33mm 7.f.g  
**113-0075**  
185mm (7.1/4") Diameter 2.66mm 8 f.g  
**113-0076**  
185mm (7.1/4") Diameter 3mm 9.f.g



**BELUCCI**  
**113-0077**  
Set comprising of each of the following items:  
**BELUCCI SUCTION TUBE**  
**113-0078** 170mm (6.3/4") Diameter: 2mm  
**ZOELLNER DETACHABLE ENDS**

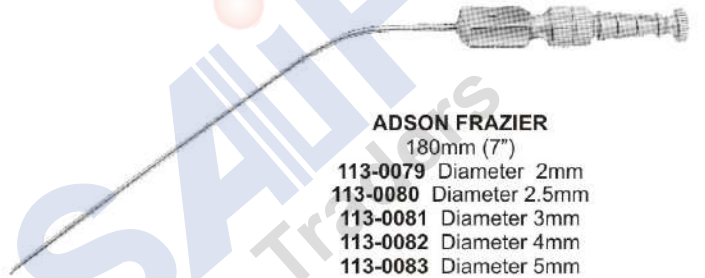

**ADSON FRAZIER**  
180mm (7")  
**113-0079** Diameter 2mm  
**113-0080** Diameter 2.5mm  
**113-0081** Diameter 3mm  
**113-0082** Diameter 4mm  
**113-0083** Diameter 5mm

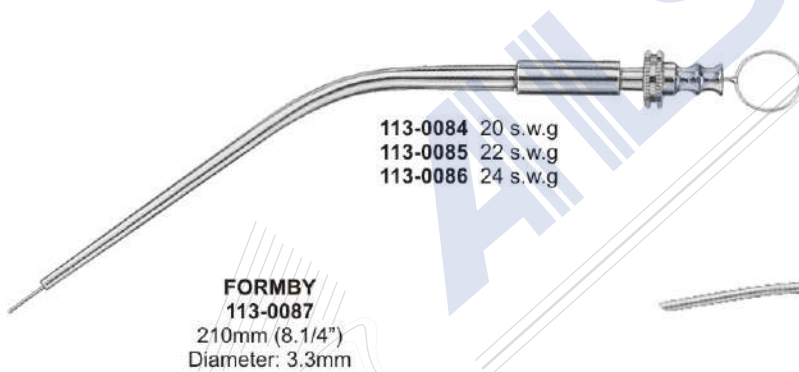

**113-0084** 20 s.w.g  
**113-0085** 22 s.w.g  
**113-0086** 24 s.w.g



**ADSON**  
180mm (7")  
**113-0088** Diameter 3mm  
**113-0089** Diameter 5mm

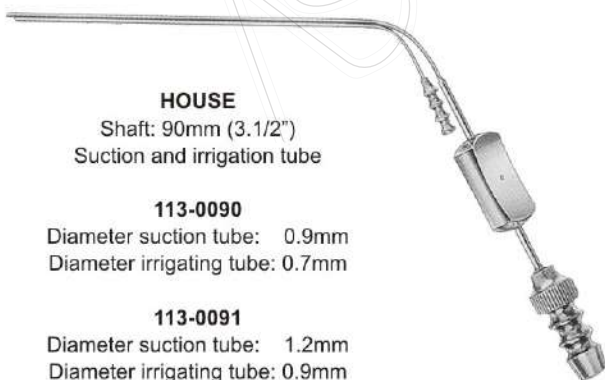

**HOUSE**  
Shaft: 90mm (3.1/2")  
Suction and irrigation tube  
**113-0090**  
Diameter suction tube: 0.9mm  
Diameter irrigating tube: 0.7mm  
**113-0091**  
Diameter suction tube: 1.2mm  
Diameter irrigating tube: 0.9mm



**CONE SUCTION TUBES**  
**113-0093**



**SUCTION TUBES**  
**113-0094** Diameter: 3mm  
**113-0095** Diameter: 4mm  
**113-0096** Diameter: 5mm

**HANDLE**  
**113-0097** 100mm (4")  
with Tucker valve

## ●●● Amputation Instruments



**PERCY AMPUTATION FLAP  
RETRACTOR**

**114-0001**  
Removable handles



**AMPUTATION SAW**  
With hinged back  
to take apart  
**114-0002**  
Blade: 230mm (9")

**114-0003**  
Spare blade for  
amputation saw



**FINGER SAW**

**114-0004**  
200mm (8")



**ARMY REGULATION  
AMPUTATION SAW**

**114-0005**  
Blade: 180mm (7")  
With hinged back  
to take apart

## Urology Bone Levers & Raspatories ●●●



**115-0001**  
 140mm (5.1/2")  
 Width at tip 2.8mm



**115-0002**  
 150mm (6")  
 Width at tip 6mm

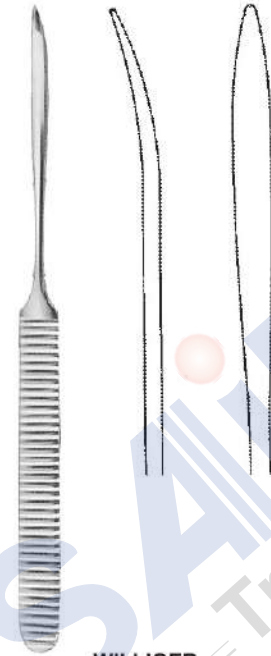

**WILLIGER**  
**115-0003**  
 175mm (7")  
 Width at tip 5.5mm

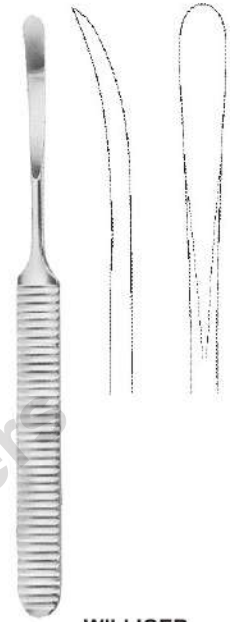

**WILLIGER**  
**115-0004**  
 160mm (6.1/4")  
 Width at tip 6.5mm

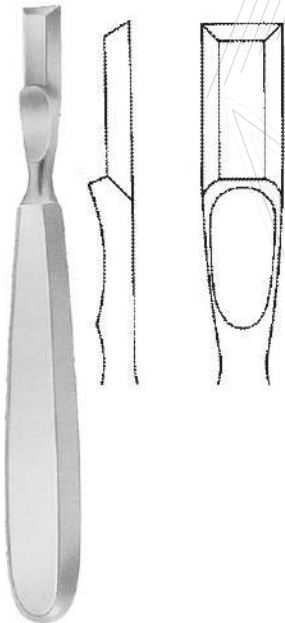

**FARABEU**  
 160mm (6.1/4")  
 8mm wide  
**115-0005** Straight  
**115-0006** Curved

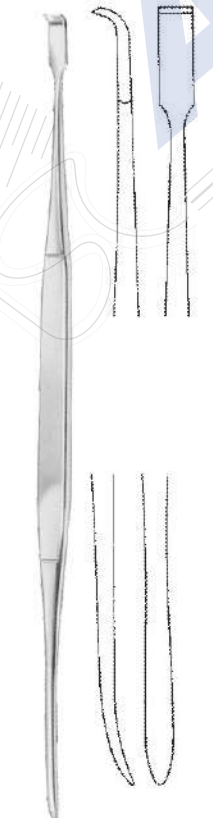

**HOWARTH**  
**115-0007** 230mm (9")



**JOSEPH**  
**115-0007**  
 170mm (6.3/4")  
 Width at tip: 4mm

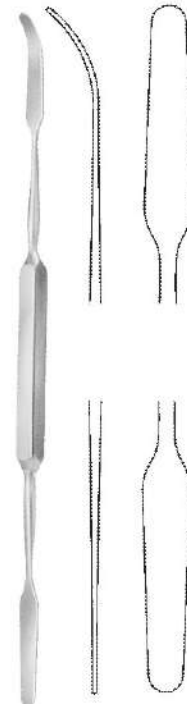

**MACDONALD**  
**115-0008**  
 185mm (7.1/4") blunt

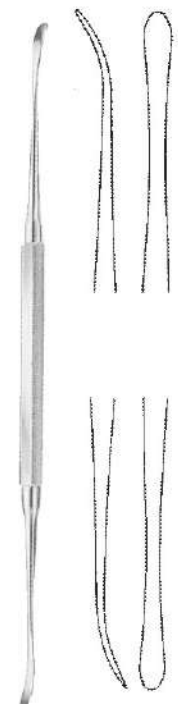

**FREER ELEVATOR**  
**115-0009**  
 190mm (7.1/2"),  
 double ended

## ●●● Bone Levers & Raspatories



**ADSON**  
165mm (6.1/2"), curved  
115-0010 width 5mm  
115-0011 width 7mm



**ADSON**  
165mm (6.1/2") slight curve  
115-0012 Width 7mm



**PENNYBACKER**  
150mm (6")  
115-0013  
Width 6mm



**VOLKMANN**  
170mm (6.3/4")

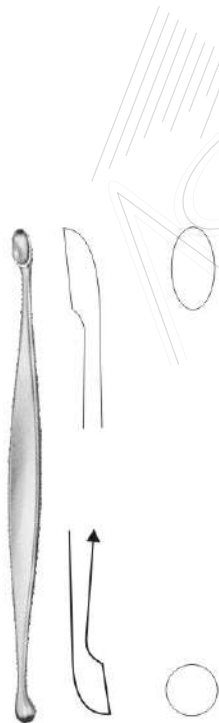
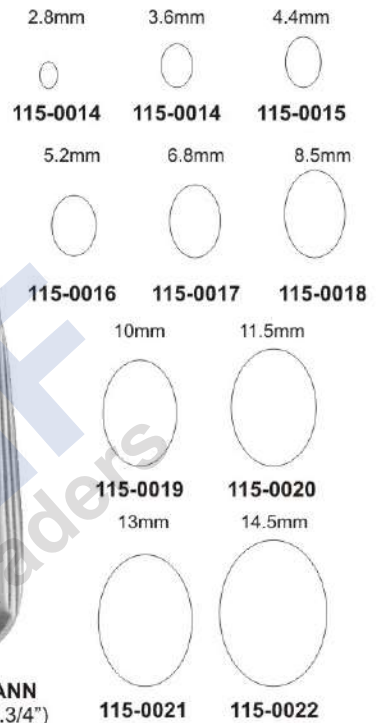

**BOYD BONE CURETTE**  
Oval, double ended  
115-0023 130mm (5.1/8")

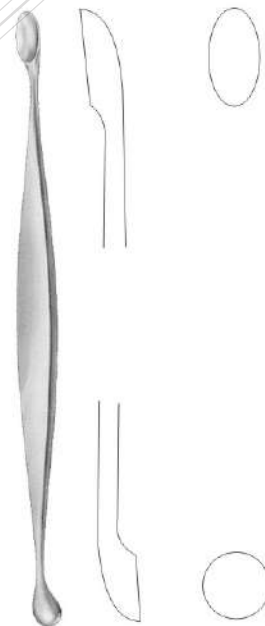

**BOYD BONE CURETTE**  
Oval, double ended  
115-0024 160mm (6.1/4")

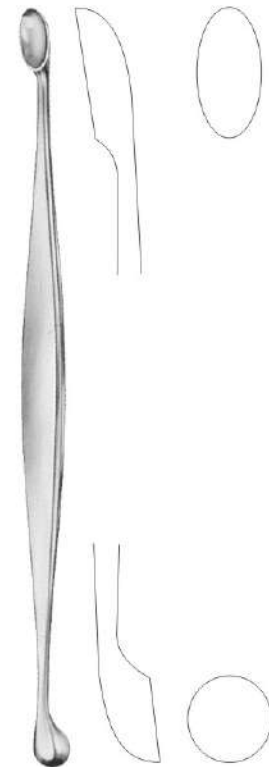

**BOYD BONE CURETTE**  
Oval, double ended  
115-0025 200mm (8")

## Bone Scoops ●●●



**VOLKMANN**  
Double ended  
**115-0026**  
130mm (5.1/8")  
**115-0027**  
140mm (5.1/2")  
**115-0028**  
170mm (6.3/4")



**MACEWEN**  
180mm (7")  
Combined  
with seeker  
**115-0029**  
Oval  
**115-0030**  
Round

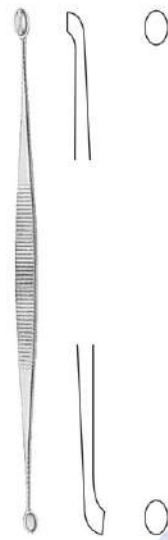

**JACOBSON**  
**115-0031**  
140mm (5.1/2")

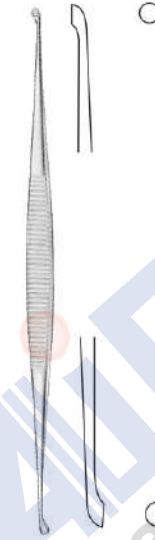

**MARTINI**  
**115-0032**  
140mm (5.1/2")

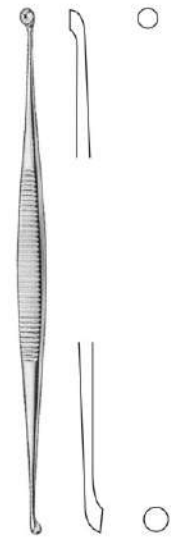

**MARTINI**  
**115-0033**  
140mm (5.1/2")



**LEMPERT**  
200mm (8")\*

**115-0034**  
2mm x 3.5mm

**115-0035**  
2mm x 4mm

**115-0036**  
2.5mm 4.5mm

**115-0037**  
2.75mm x 5mm

**115-0038**  
3mm x 5.5mm

**115-0039**  
3.25mm x 6mm



**115-0040**  
2mm x 3mm



**115-0041**  
3mm x 4mm

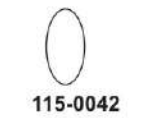

**115-0042**  
4mm x 5mm

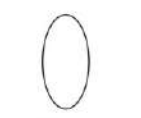

**115-0043**  
5mm x 6mm



**COLLIER AND MORRIS**  
180mm (7")

● ● ● Mallets, Bone Holding Forceps



**LUCAE**  
116-0001  
Diameter: 27mm  
8.1/2 oz



**KELSEY FRY**  
116-0002 190mm (7.1/2")  
Diameter: 20mm  
**SPARE DISKS**  
116-0003 Spare disks for  
Kelsey-Fry Mallet



**HEATH**  
116-0004  
Diameter: 25mm 28 oz  
116-0005  
Diameter: 40mm 36 oz



**SEQUESTUM**  
**FORCEPS**  
116-0006  
190mm (7.1/2")  
Straight



**SEQUESTUM**  
**FORCEPS**  
116-0007  
190mm (7.1/2")  
Angled



**FERGUSSON**  
116-0008  
200mm (8")

## Bone Holding Forceps ●●●

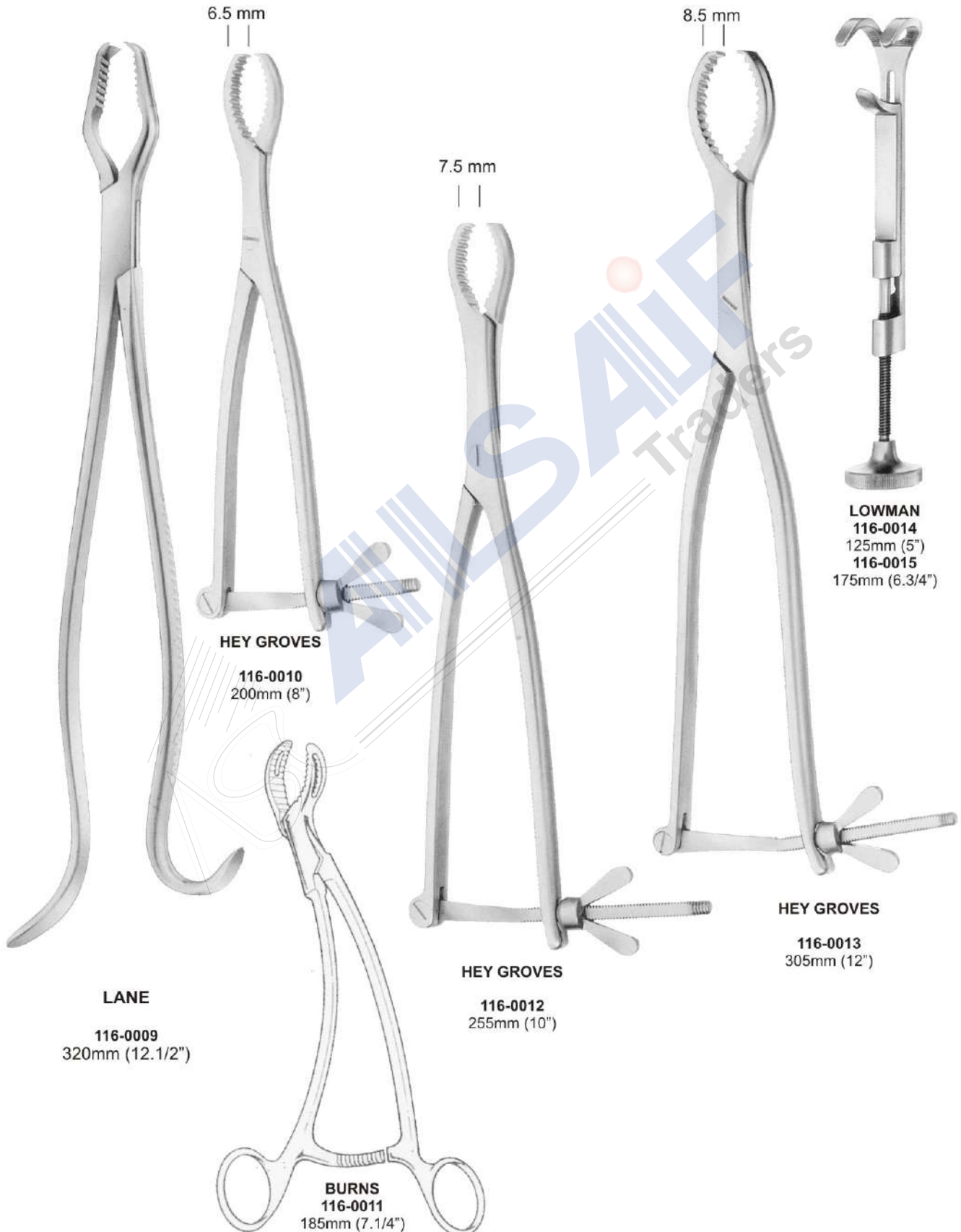

**LANE**  
116-0009  
320mm (12.1/2")

**HEY GROVES**

116-0010  
200mm (8")

**HEY GROVES**

116-0012  
255mm (10")

**HEY GROVES**

116-0013  
305mm (12")

**BURNS**  
116-0011  
185mm (7.1/4")

**LOWMAN**  
116-0014  
125mm (5")  
116-0015  
175mm (6.3/4")

## ● ● ● Bone Holding Forceps



**VERBRUGGE**

**116-0016**  
250mm (9.3/4")



**116-0017**  
255mm (10")



**VERBRUGGE**

**116-0019**  
175mm (7")



**116-0018**  
265mm (10.1/2")



**LEWIN**  
**116-0020**  
135mm (5.1/4")

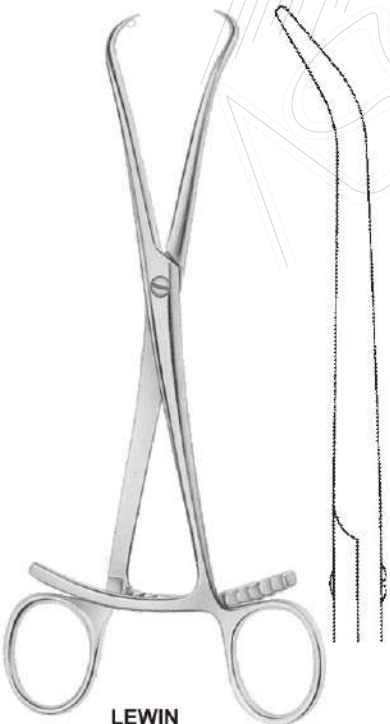

**LEWIN**  
**116-0021** 205mm (8")



**DINGMAN**

**116-0022**  
190mm (7.1/2")  
Light pattern

**116-0023**  
190mm (7.1/2")  
Heavy pattern



**SEMB**  
**116-0024**  
190mm (7.1/2")

8mm



## Bone Rongeurs ●●●



**BEYER**  
117-0001  
150mm (6")  
5mm bite



**JANSEN-MIDDLETON  
SEPTUM FORCEPS**  
117-0002  
200mm (8") Spoon shaped  
4mm bite



**CAIRNS**  
117-0003  
140mm (5.1/2")  
4mm bite



**CAIRNS**  
117-0004  
140mm (5.1/2")  
4mm bite



**LUER**  
117-0005  
155mm (6")

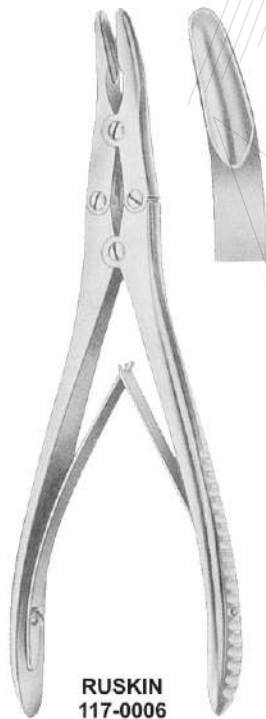

**RUSKIN**  
117-0006  
190mm (7.1/2")  
6mm bite

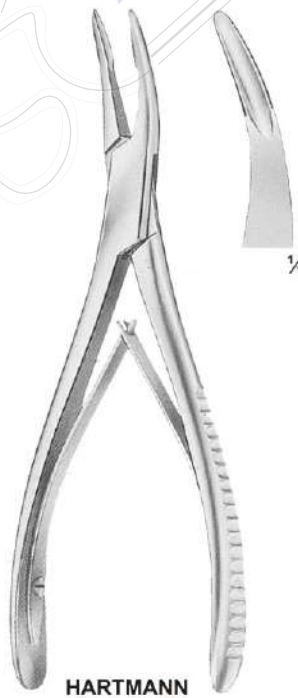

**HARTMANN**  
117-0007  
180mm (7")



**MEAD**  
117-0008  
165mm (6.1/2")



**JANSEN**  
117-0009  
150mm (6")

## ●●● Bone Rongeurs



**TROTTER**  
117-0010  
200mm (8")  
10mm bite



**SYNOVECTOMY RONGEUR**  
117-0011  
175mm (7")

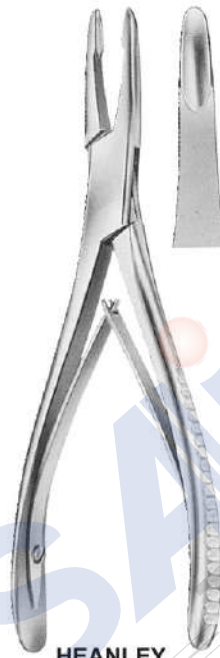

**HEANLEY**  
117-0012  
175mm (7")  
4mm bite

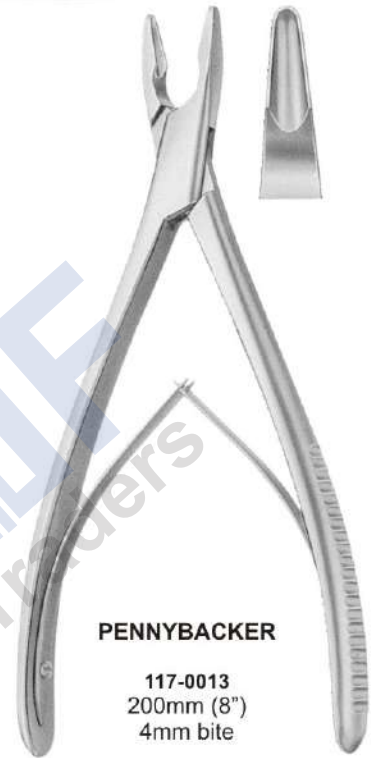

**PENNYBACKER**  
117-0013  
200mm (8")  
4mm bite

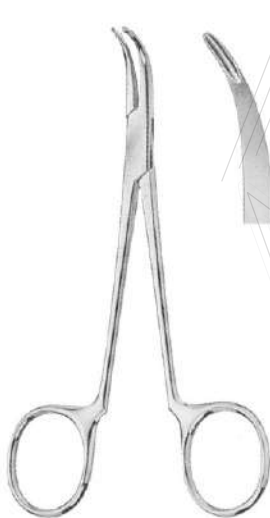

**SYNOVECTOMY RONGEUR**  
117-0014  
130mm (5.1/8")  
Jaw width 2mm



**NORTHFIELD**  
117-0015  
200mm (8")  
10mm bite



**WILMS**  
117-0016  
200mm (8")  
4mm bite



**LEKSELL**  
117-0017  
240mm  
(9.1/2")  
6mm bite  
117-0018  
240mm  
(9.1/2")  
8mm bite

## Bone Rongeurs ●●●

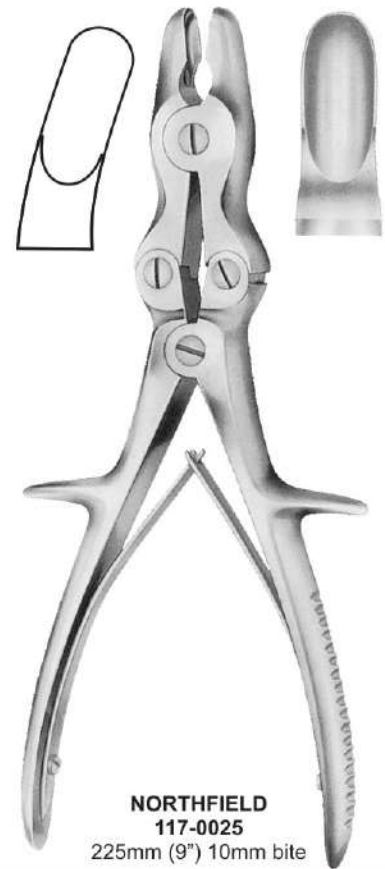
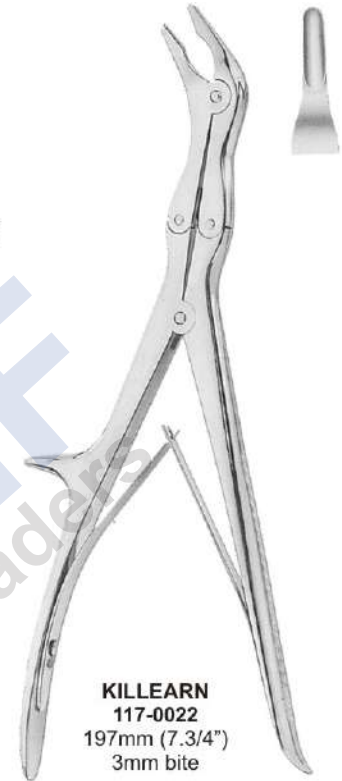
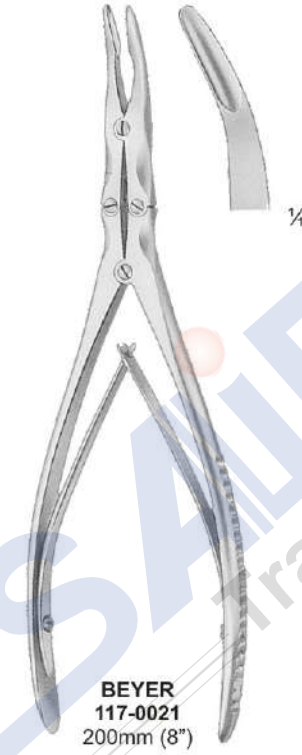

## ●●● Bone Rongeurs



**SARGENT (VAN HAVRE)**  
117-0026  
220mm (8.3/4")  
10mm bite



**OLIVECRONA**  
117-0027  
230mm (9")  
6mm bite

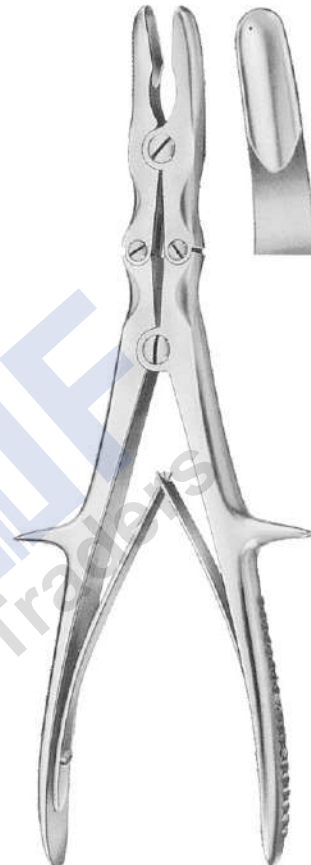

**STILLE-RUSKIN**  
117-0028  
240mm (9.1/2")

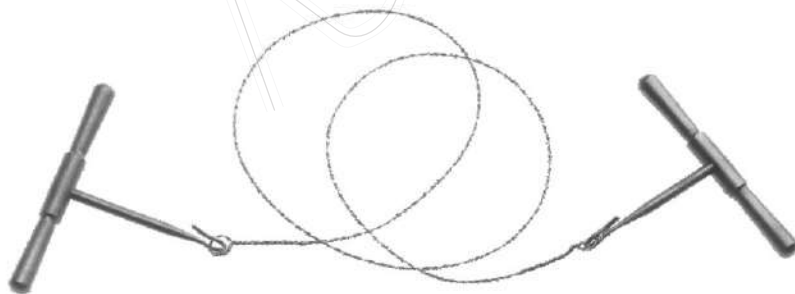

**GIGLI SAW WITH HANDLE**

117-0029  
500mm (20")



**RUDOR EDWARDS COSTOTOME**

117-0030  
230mm (9")

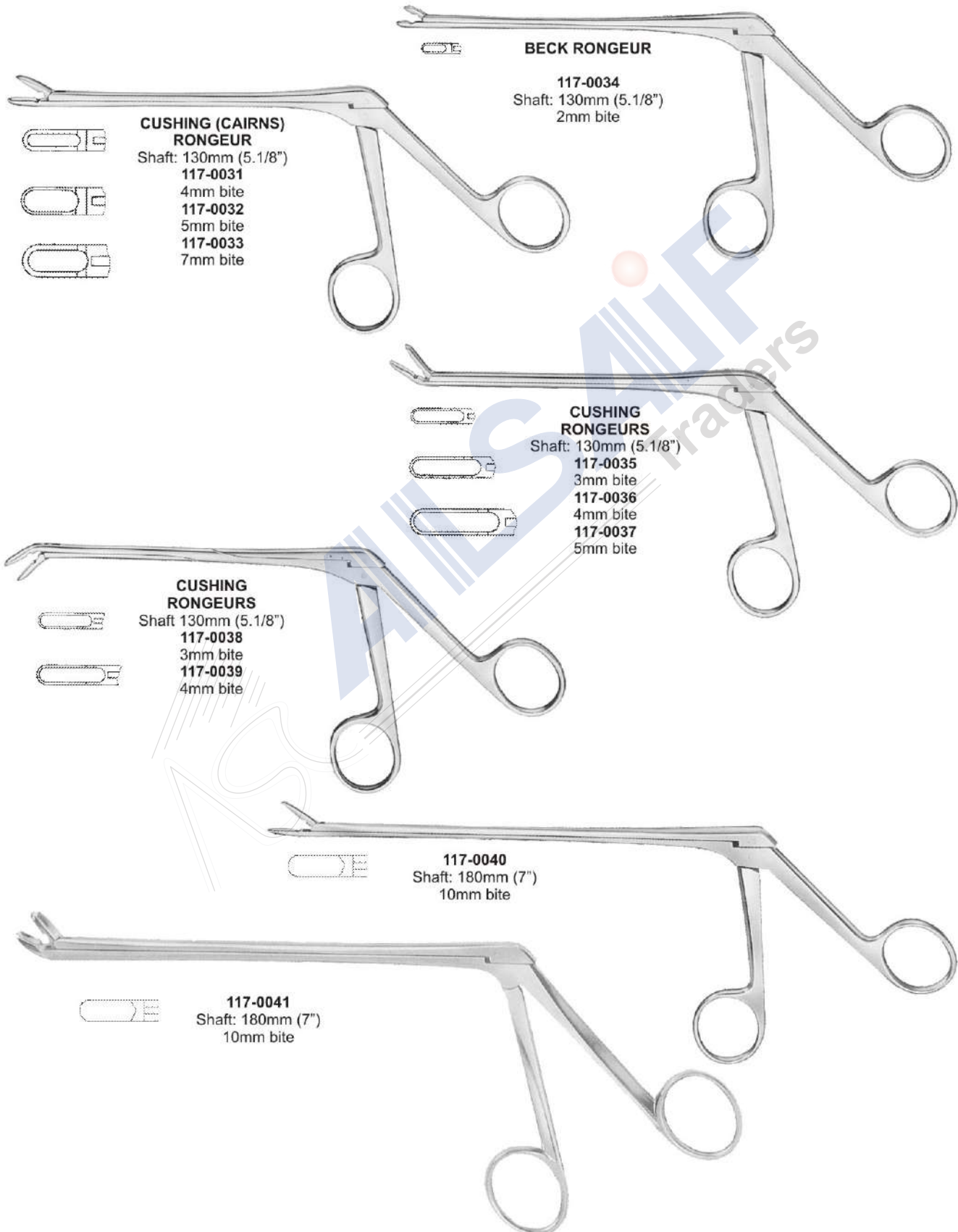

## ● ● ● Bone Cutting Forceps

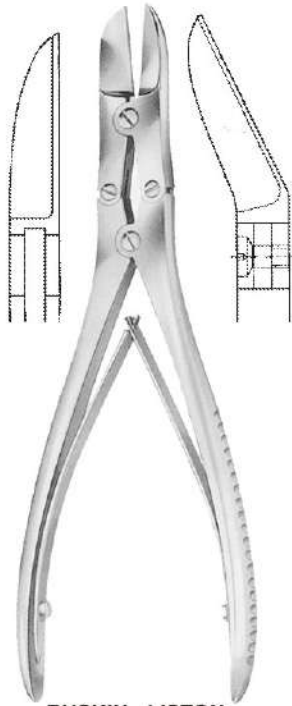

**RUSKIN - LISTON**  
117-0042 190mm (7.1/2")  
Straight  
117-0043 190mm (7.1/2")  
Angled on flat



**WARD**  
117-0044  
170mm (6.3/4")

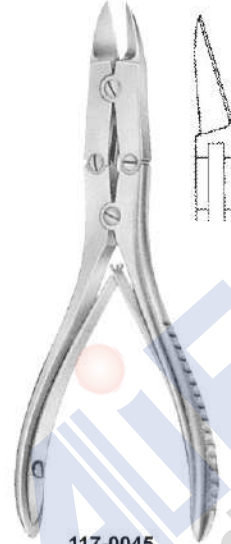

117-0045  
145mm (5.3/4")



117-0046  
150mm (6")

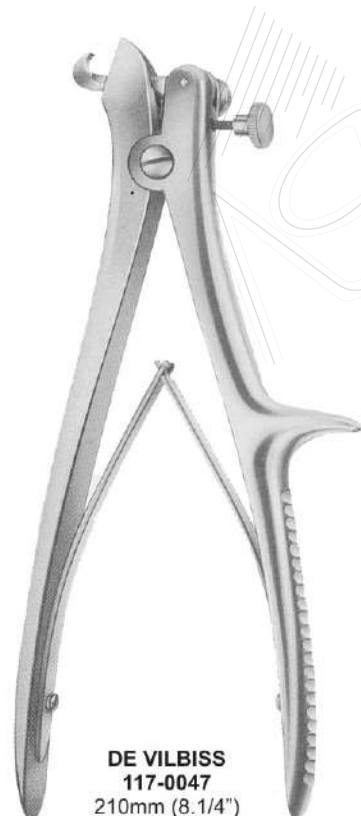

**DE VILBISS**  
117-0047  
210mm (8.1/4")



**LISTON  
(TUDOR EDWARDS)**  
117-0048  
265mm (10.1/2")

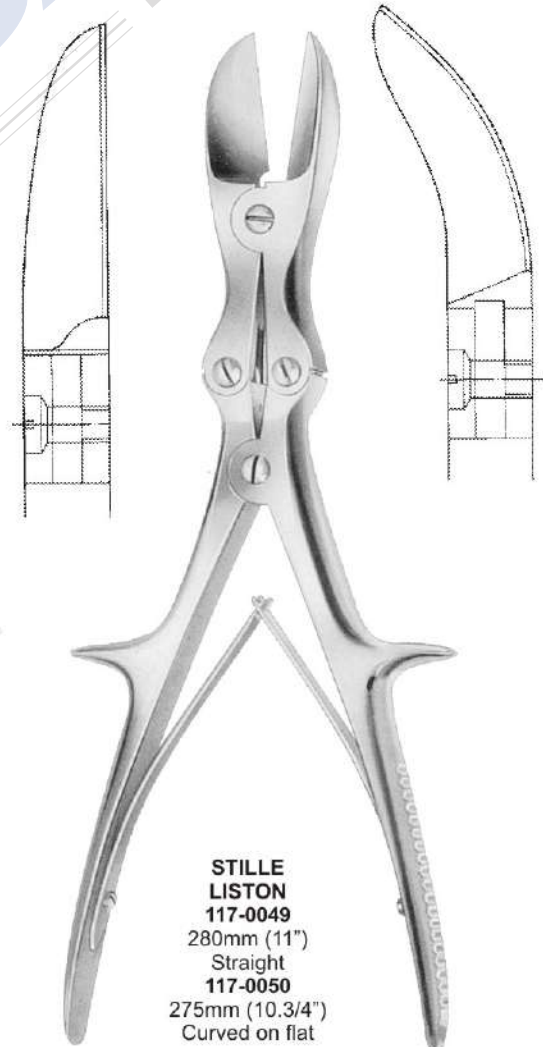

**STILLE  
LISTON**  
117-0049  
280mm (11")  
Straight  
117-0050  
275mm (10.3/4")  
Curved on flat



**PLASTER SHEARS**

**118-0001**  
160mm (6.1/4")

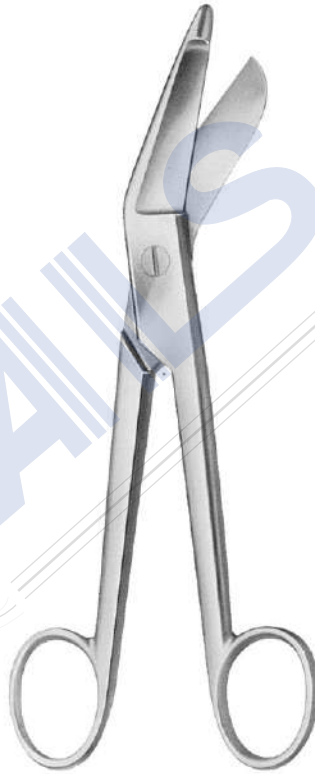

**PLASTER SHEARS**

**118-0002**  
200mm (8")

**118-0003**  
230mm (9")



**PLASTER SHEARS**

**118-0004**  
235mm (9.1/4")

## ●●● Rib Spreaders

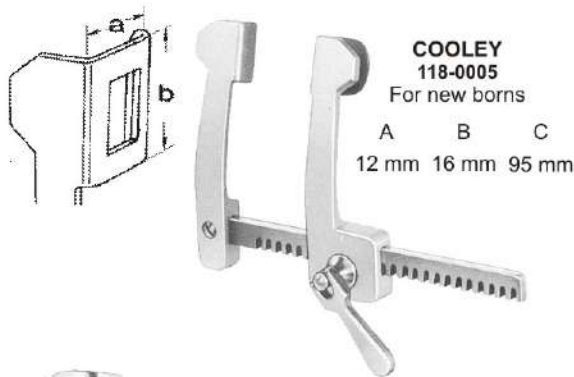

**COOLEY**  
118-0005  
For new borns

A	B	C
12 mm	16 mm	95 mm

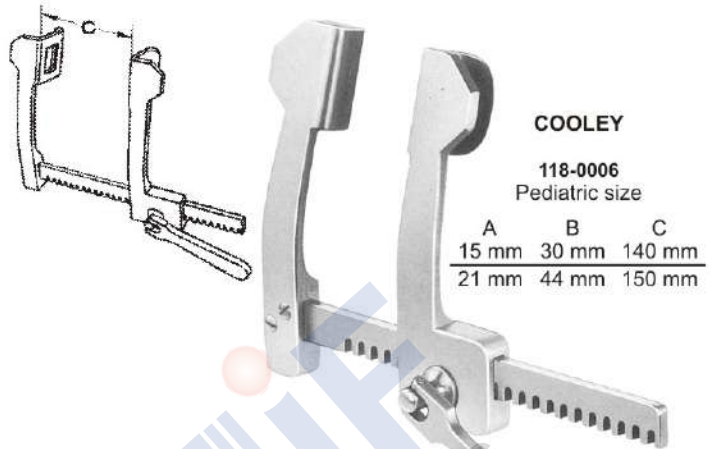

**COOLEY**

118-0006  
Pediatric size

A	B	C
15 mm	30 mm	140 mm
21 mm	44 mm	150 mm



**COOLEY**

118-0007  
For adults

A	B	C
35 mm	50 mm	200 mm

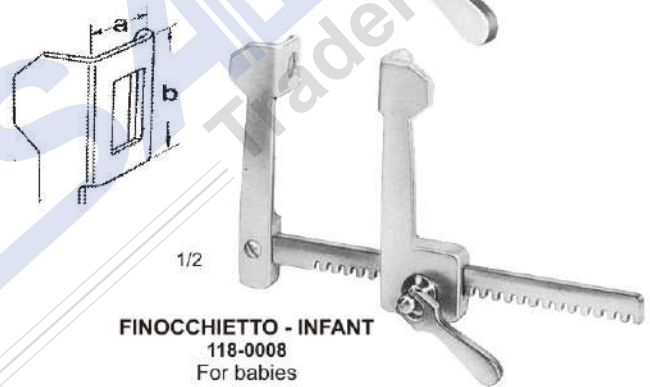

**FINOCCHIETTO - INFANT**

118-0008  
For babies

a	b	c
15mm	15mm	75mm

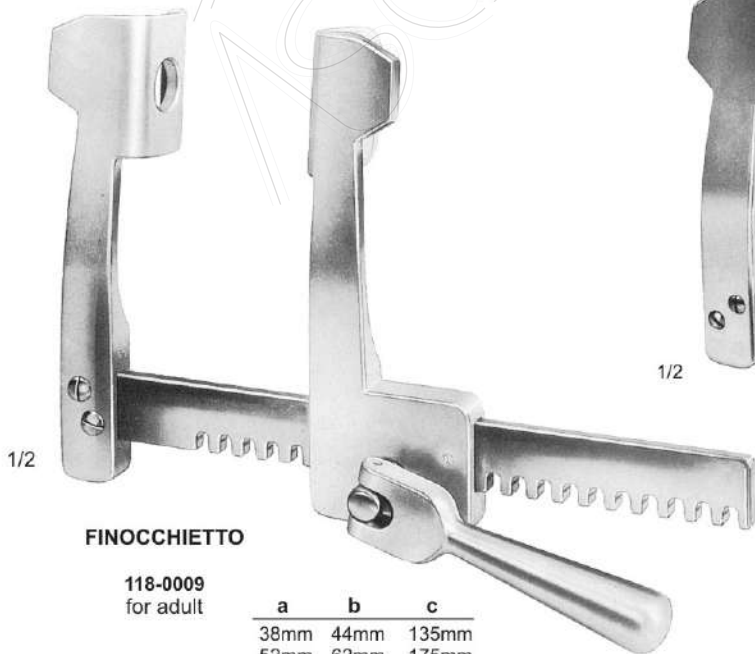

**FINOCCHIETTO**

118-0009  
for adult

a	b	c
38mm	44mm	135mm
52mm	62mm	175mm
85mm	65mm	175mm

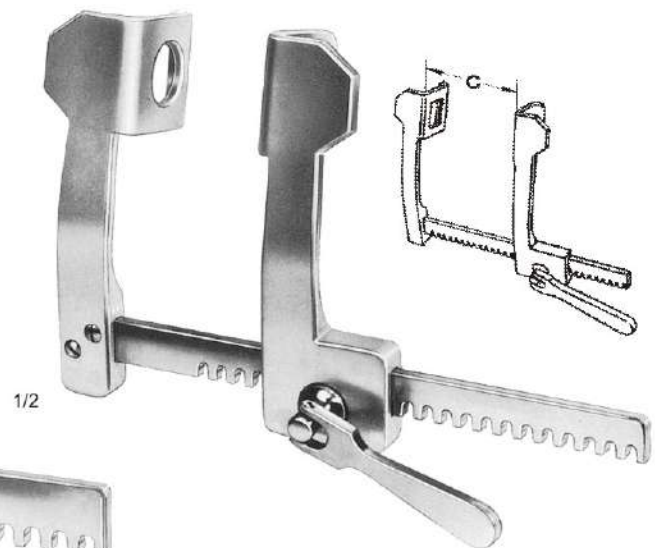

**FINOCCHIETTO-BABY**

118-0010  
Child size

a	b	c
31mm	31mm	100mm



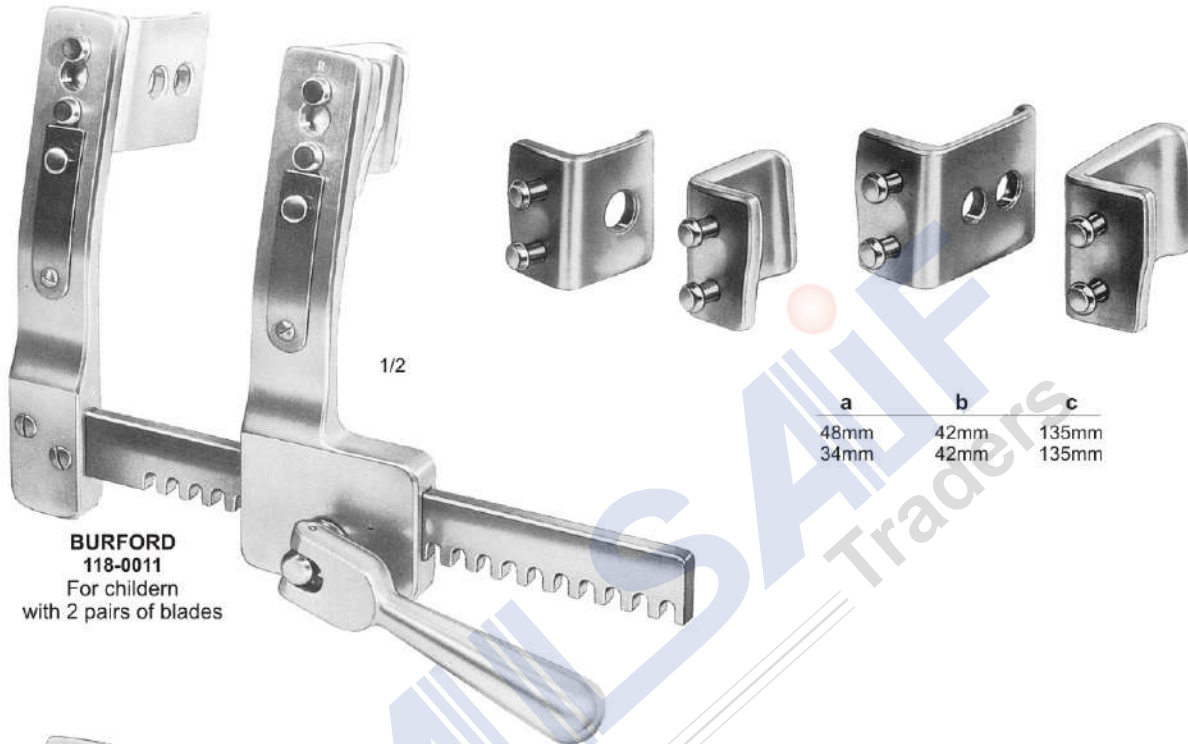

**BURFORD**  
**118-0011**  
 For children  
 with 2 pairs of blades

a	b	c
48mm	42mm	135mm
34mm	42mm	135mm



**BURFORD**  
**118-0012**  
 for adults  
 with pairs of blades

a	b	c
64mm	62mm	180mm
47mm	62mm	
65mm	62mm	260mm
47mm	62mm	
65mm	62mm	300mm
47mm	62mm	

●●● Bronchus, Ligature, Tissue & Organ Holding Forceps

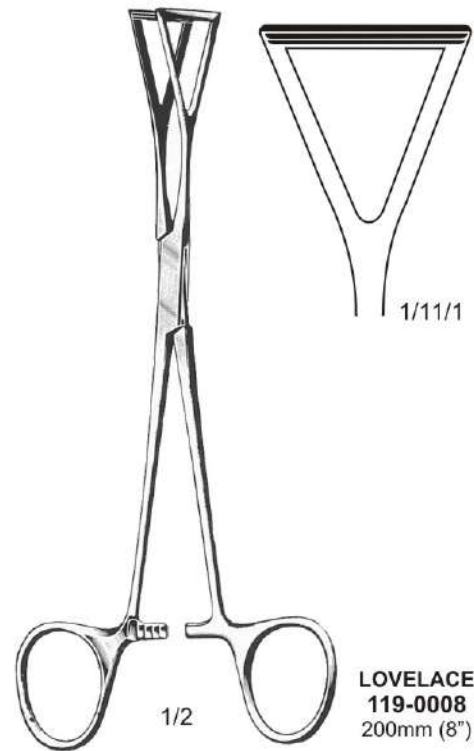
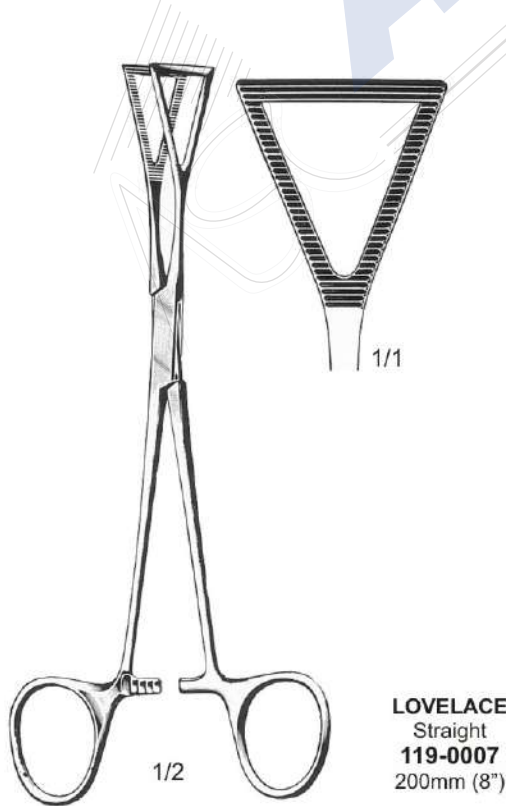
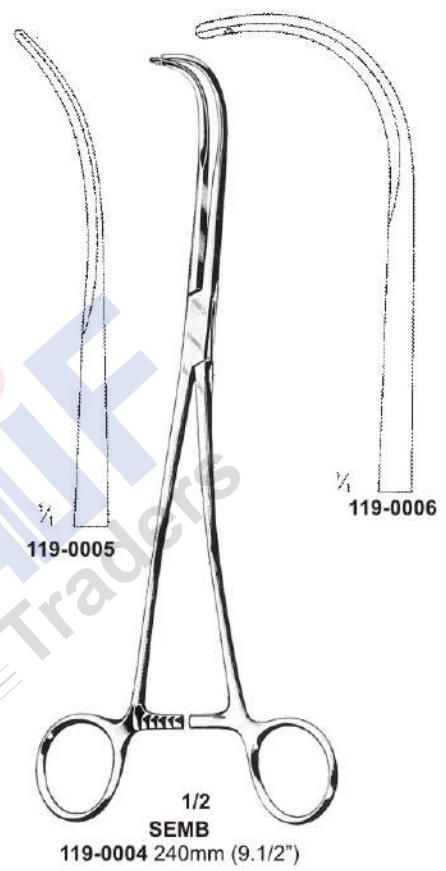
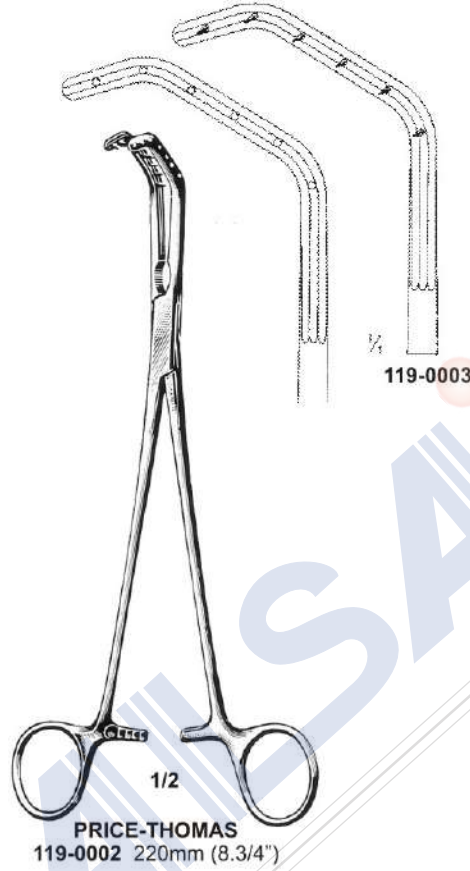
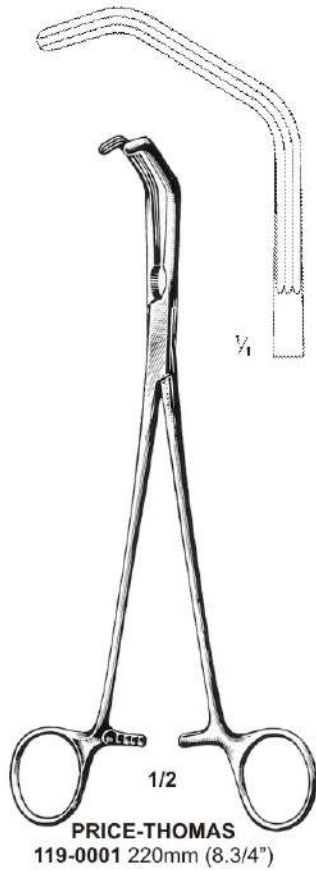

## Atrauma Bulldog Clamps ●●●



**DE-BAKEY SATINSKY**  
119-0009 70mm (2.3/4")

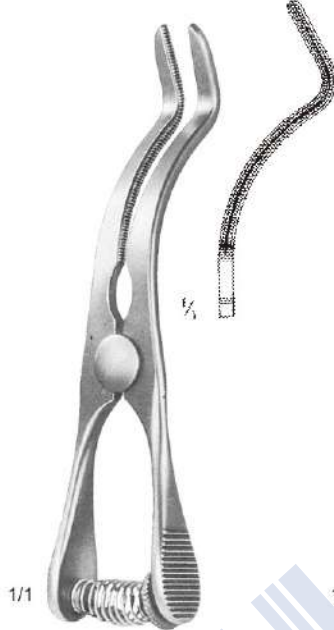

**DE BAKEY-CAROTIS**  
119-0010 90mm (3.1/2")

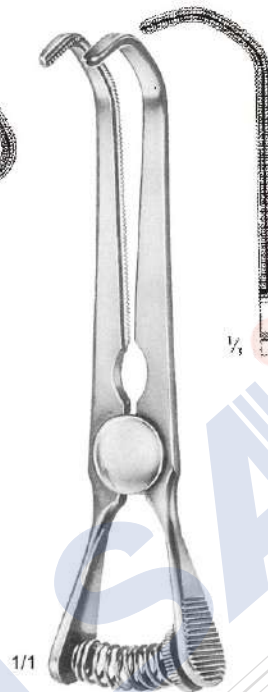

**DE BAKEY SATINSKY**  
119-0011 100mm (4")



**GREGORY-SOFT**

**119-0012**  
90mm (3/12")

**119-0014**  
110mm (4.1/2")



**119-0012**



**119-0013**



**DEBAKEY BULLDOG CLAMPS**



**119-0014**  
75mm (3")



**119-0015**  
85mm (3.1/2")



**119-0016**  
105mm (4.1/4")



**119-0017**  
120mm (4.3/4")



**DEBAKEY BULLDOG CLAMPS**



**119-0018**  
70mm (2.3/4")



**119-0019**  
80mm (3.1/4")



**119-0020**  
100mm (4")

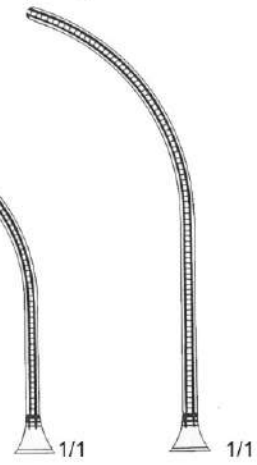

**119-0021**  
115mm (4.3/4")

## ●●● Atrauma Hemostatic, Cardiovascular Forceps

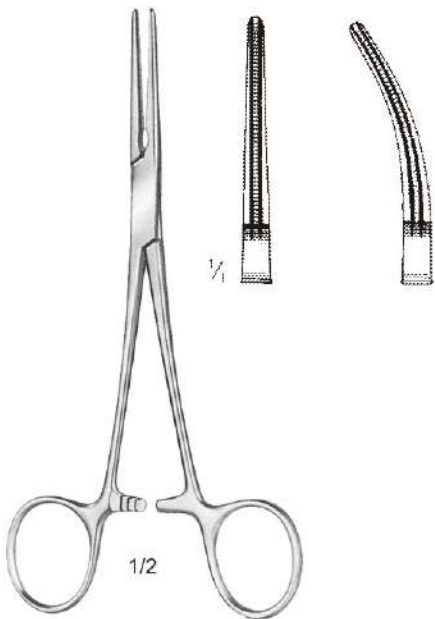

**DE BAKY-RANKIN**  
120-0001  
Straight 160mm (6.1/4")  
120-0002  
Curved 160mm (6.1/4")

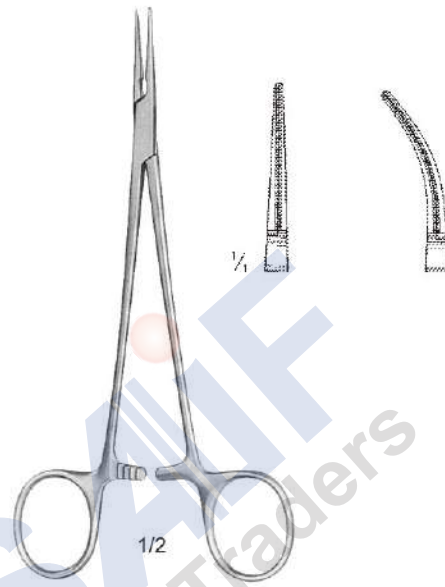

**DE BAKY-MOSQUITO**  
120-0003  
Straight 150mm (6")  
Curved 150mm (6")

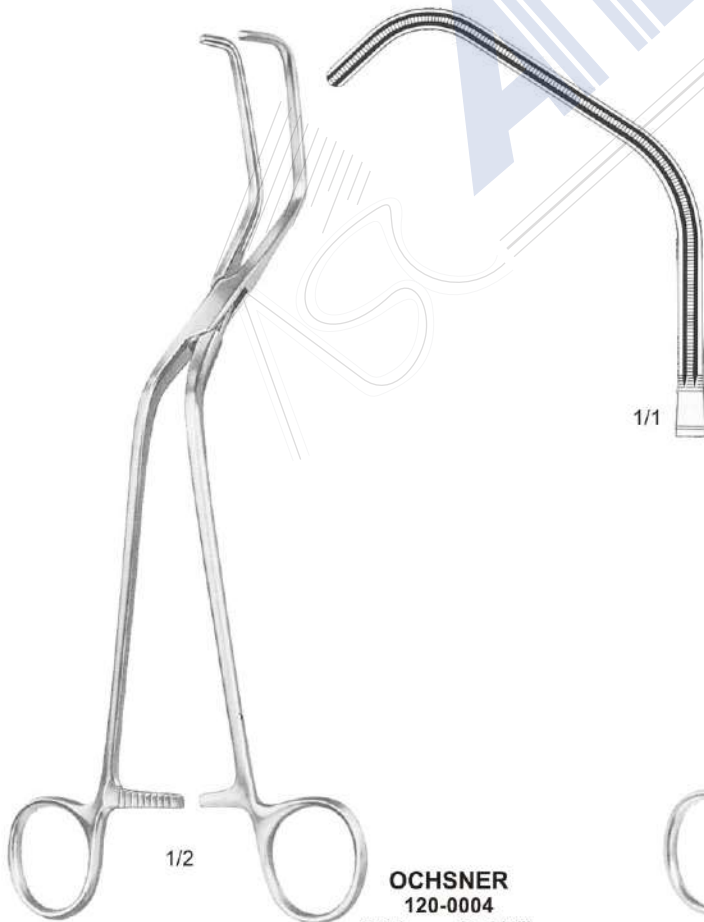

**OCHSNER**  
120-0004  
235mm (9.1/4")

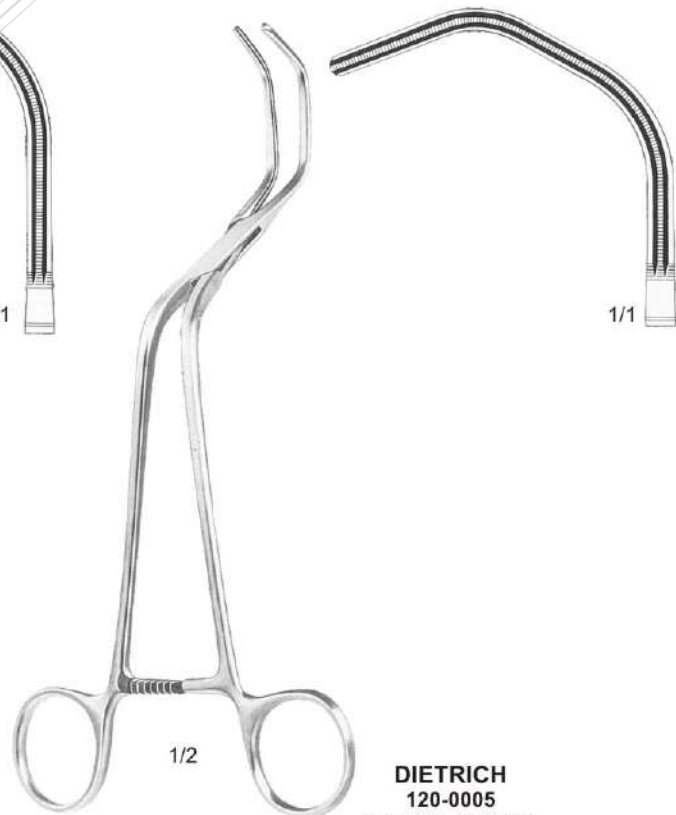

**DIETRICH**  
120-0005  
210mm (8.1/4")

## Atrauma Cardiovascular Forceps ●●●

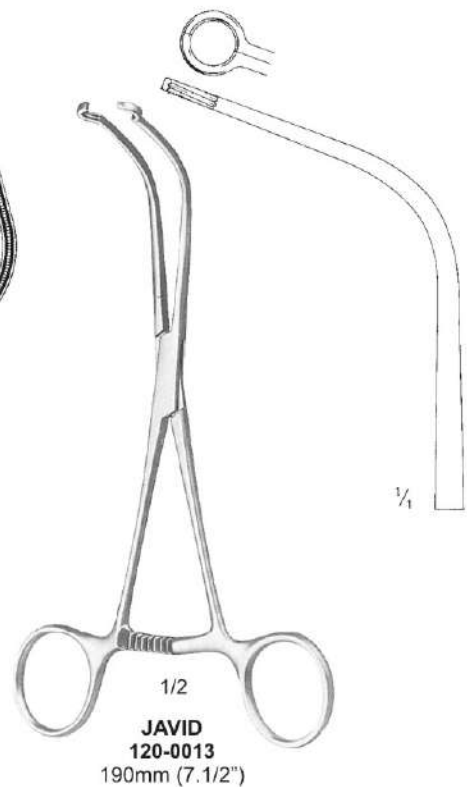
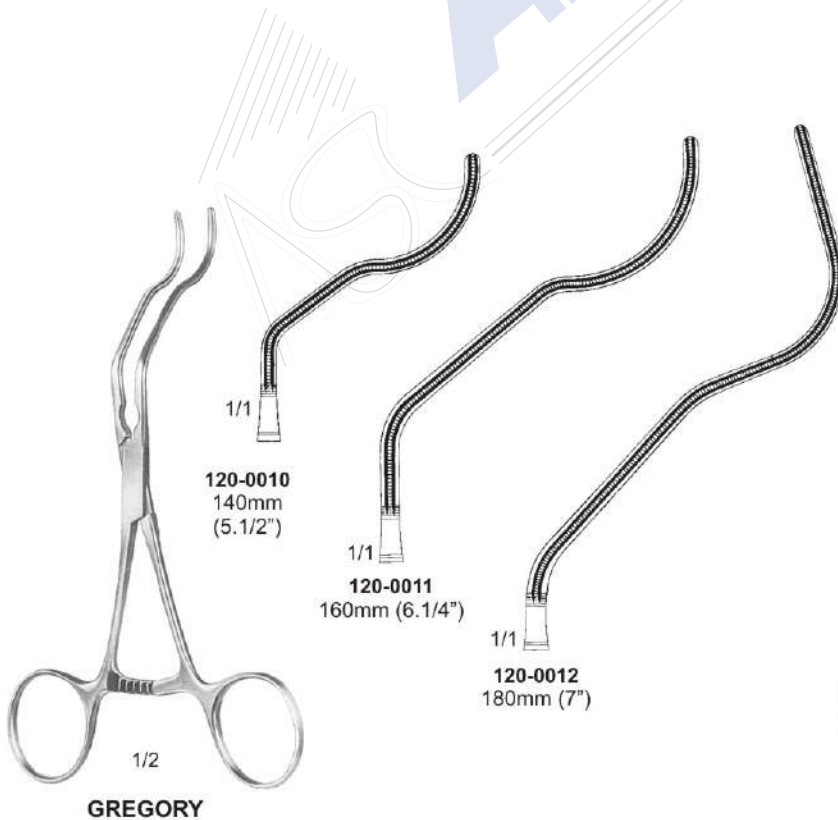
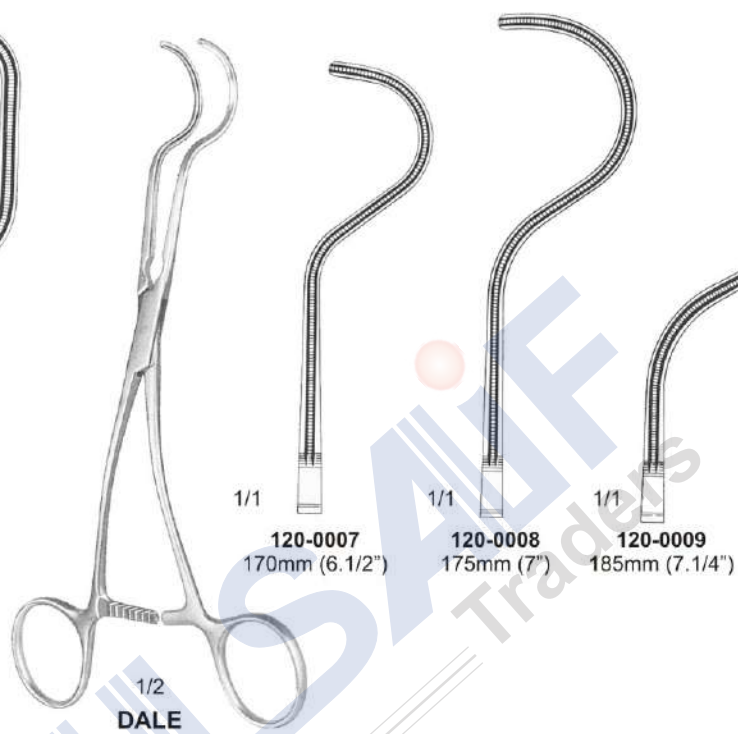
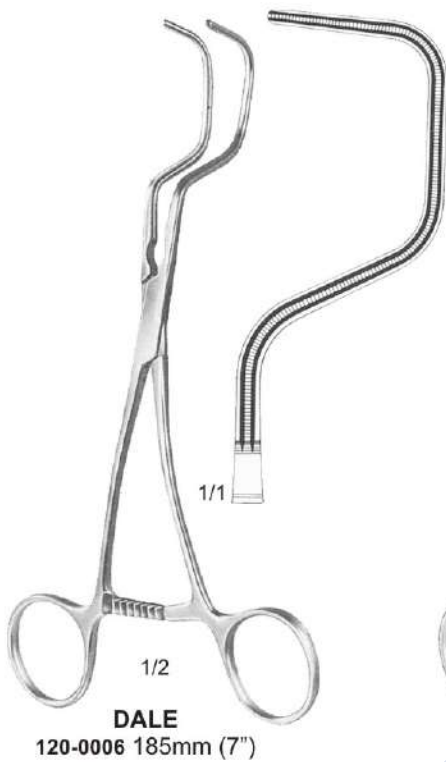

## ●●● Atrauma Cardiovascular Forceps

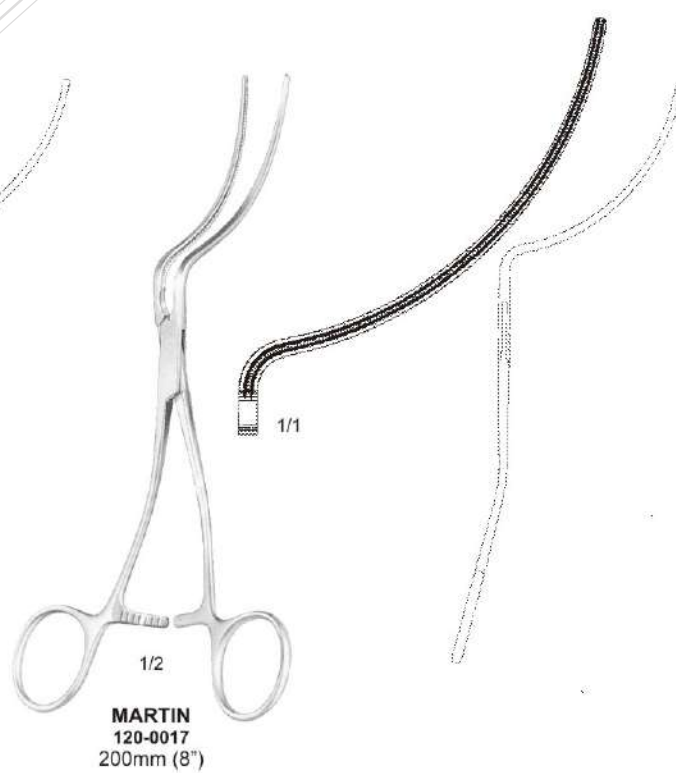
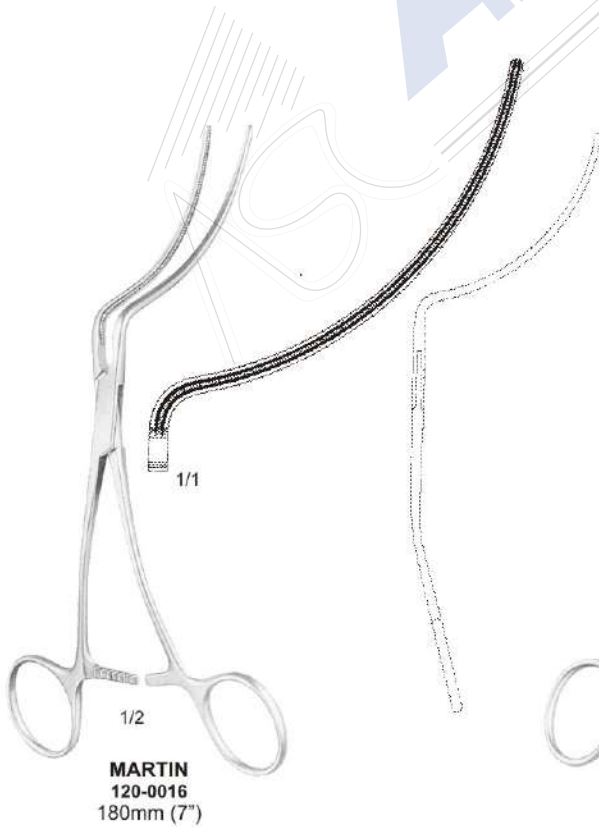
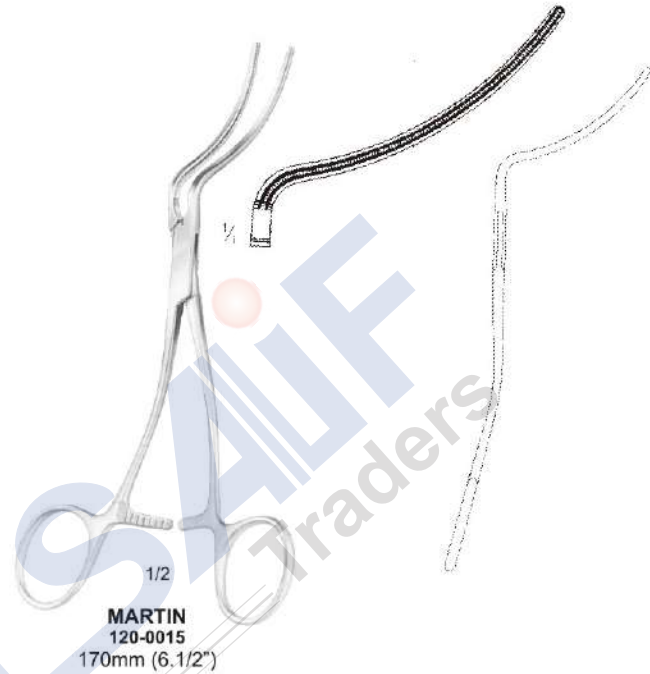
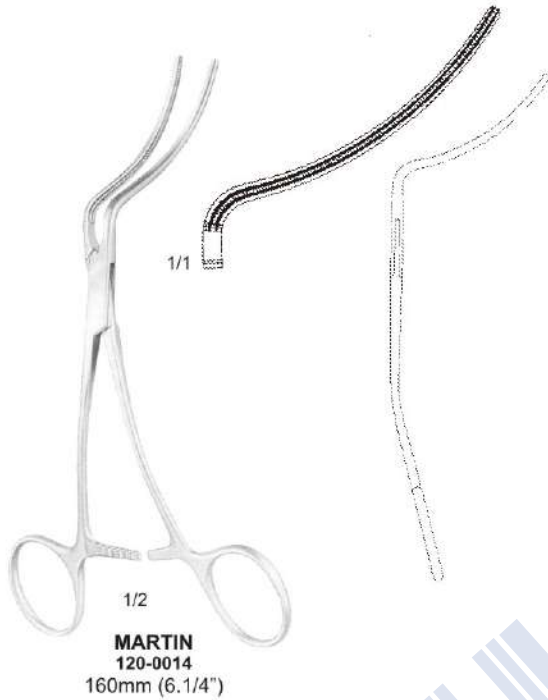

## Vascular Measuring Device, Forceps ●●●

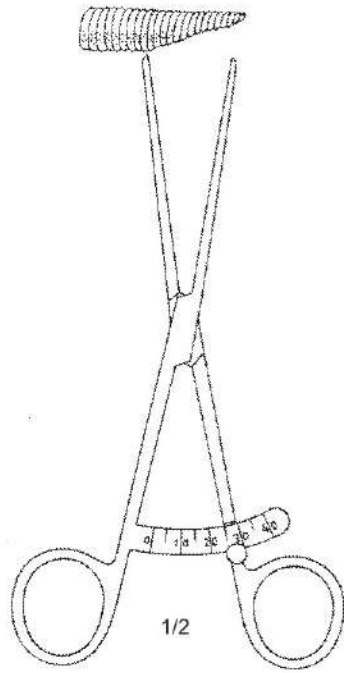

**MEASURING FORCEPS**

**120-0018**  
Straight - 180mm (7")

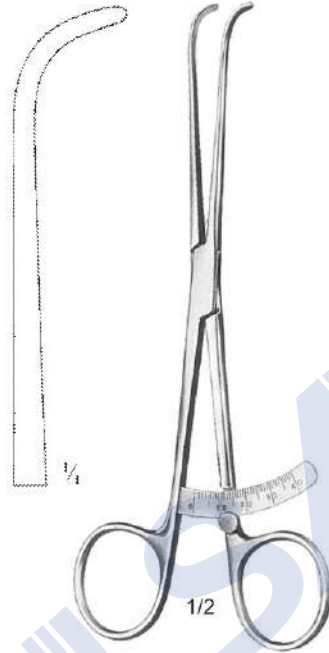

**MEASURING FORCEPS**

**120-0019**  
Straight - 180mm (7")

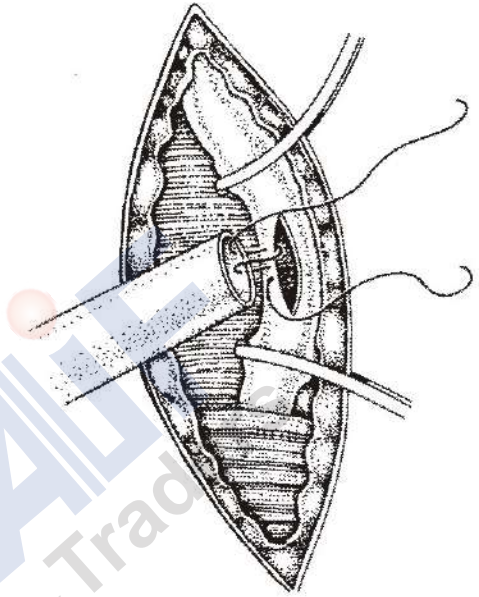

Cooley type caval occlusion used during cardiopulmonary By-Pass for occluding the vena caval. The tips of the instrument permit flow indwelling cannula

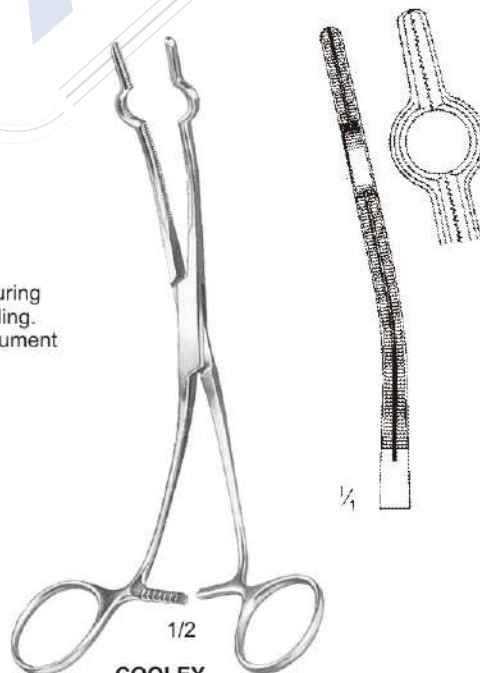

**COOLEY**  
**120-0020**  
child  
**120-0021**  
adult

## ●●● Atrauma Tissue Forceps

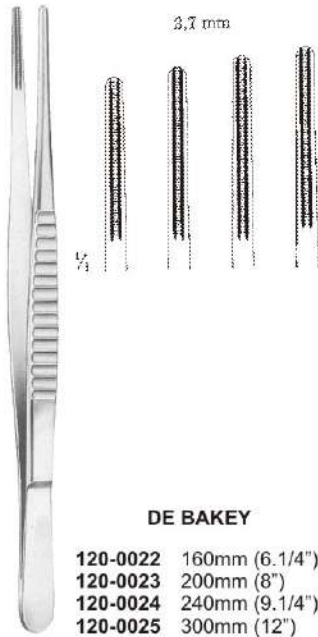

**DE BAKY**

- 120-0022 160mm (6.1/4")
- 120-0023 200mm (8")
- 120-0024 240mm (9.1/4")
- 120-0025 300mm (12")



**DE BAKY**

- 120-0026 160mm (6.1/4")
- 120-0027 200mm (8")
- 120-0028 240mm (9.1/4")

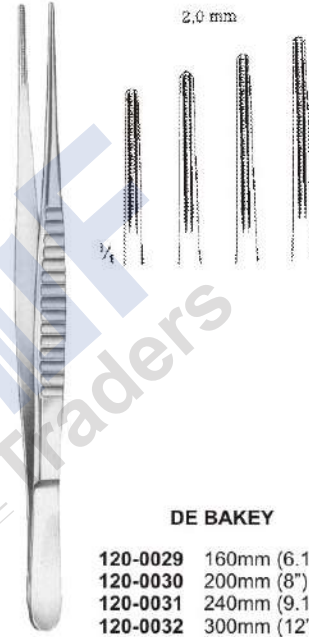

**DE BAKY**

- 120-0029 160mm (6.1/4")
- 120-0030 200mm (8")
- 120-0031 240mm (9.1/4")
- 120-0032 300mm (12")

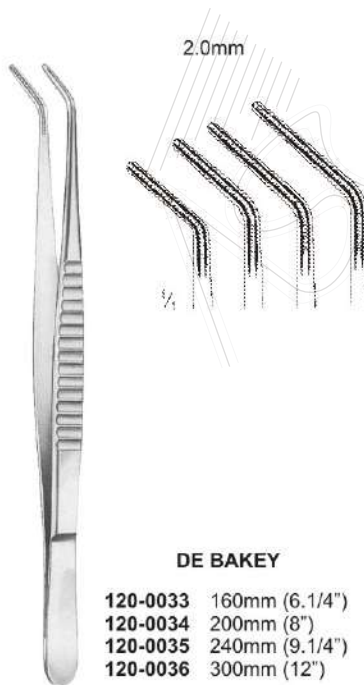

**DE BAKY**

- 120-0033 160mm (6.1/4")
- 120-0034 200mm (8")
- 120-0035 240mm (9.1/4")
- 120-0036 300mm (12")

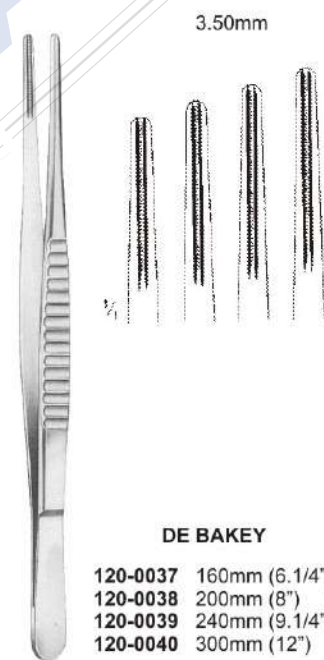

**DE BAKY**

- 120-0037 160mm (6.1/4")
- 120-0038 200mm (8")
- 120-0039 240mm (9.1/4")
- 120-0040 300mm (12")

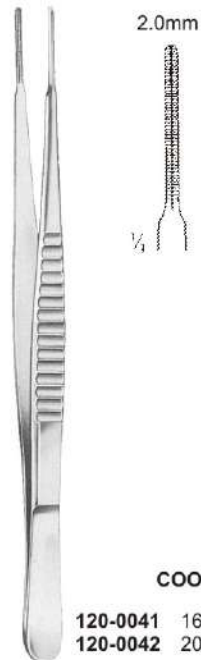

**COOLEY**

- 120-0041 160mm (6.1/4")
- 120-0042 200mm (8")



## Atrauma Cardiovascular Forceps ●●●



## ●●● Atrauma Cardiovascular Forceps

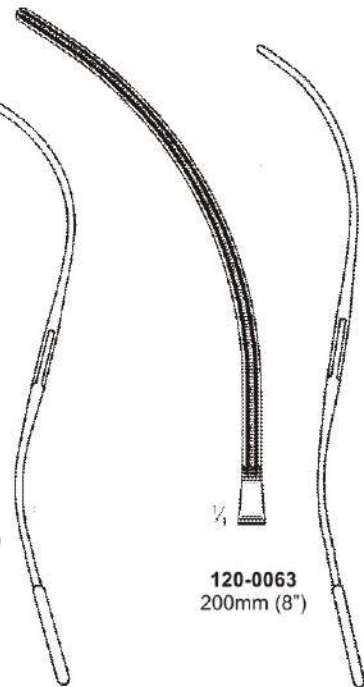
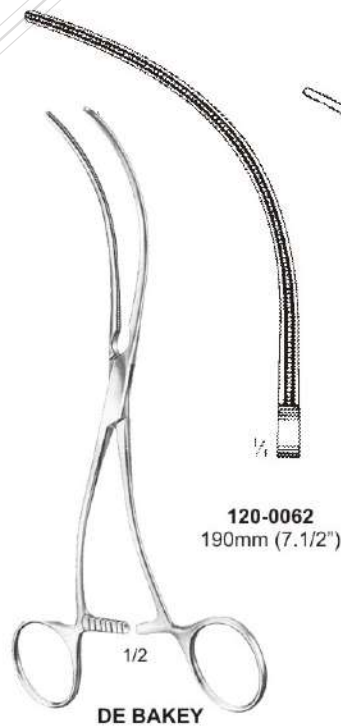
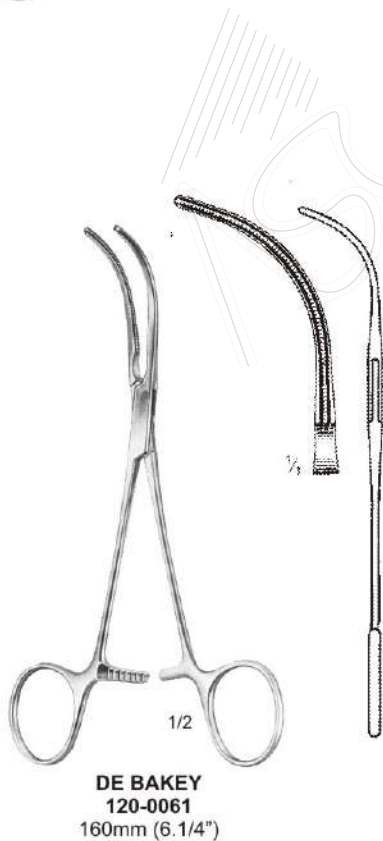
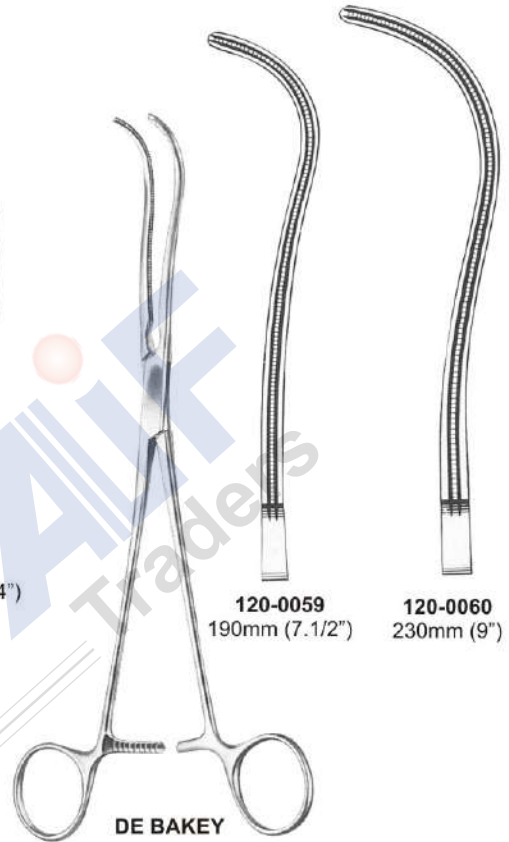
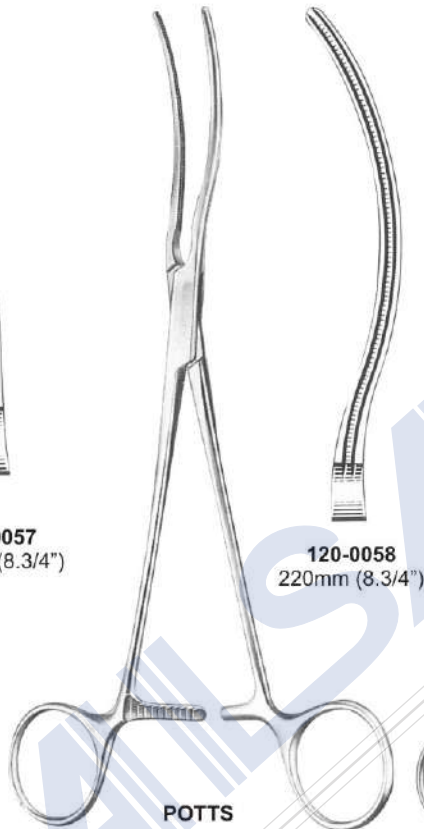

## Atrauma Cardiovascular Forceps ●●●

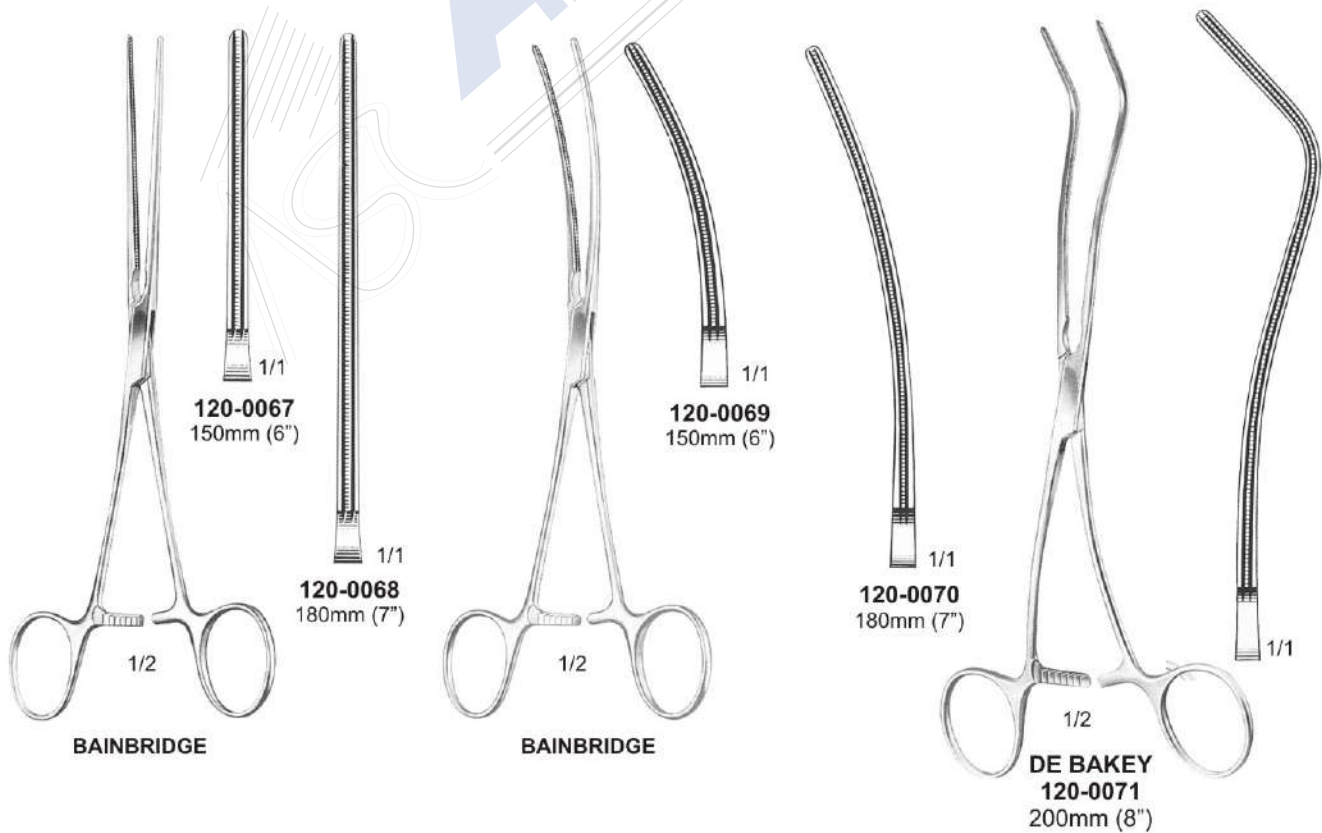
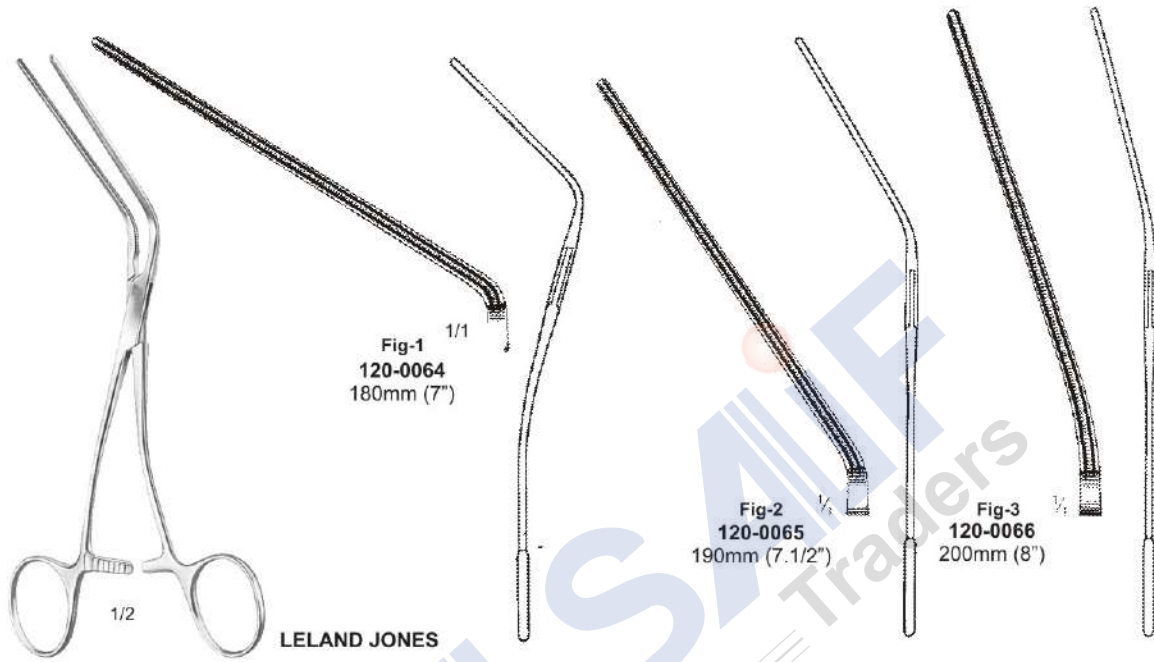

## ●●● Atrauma Cardiovascular Forceps

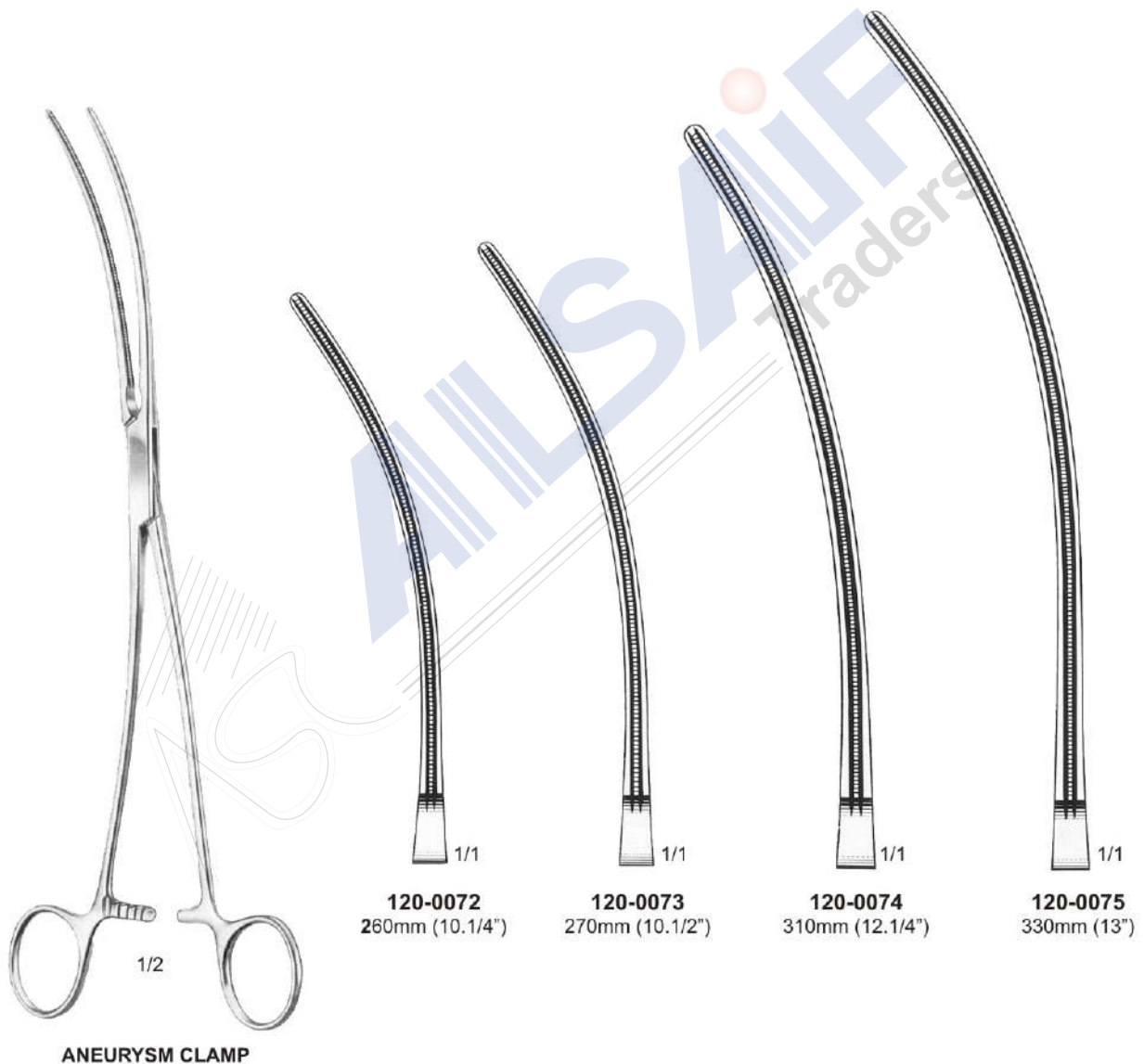

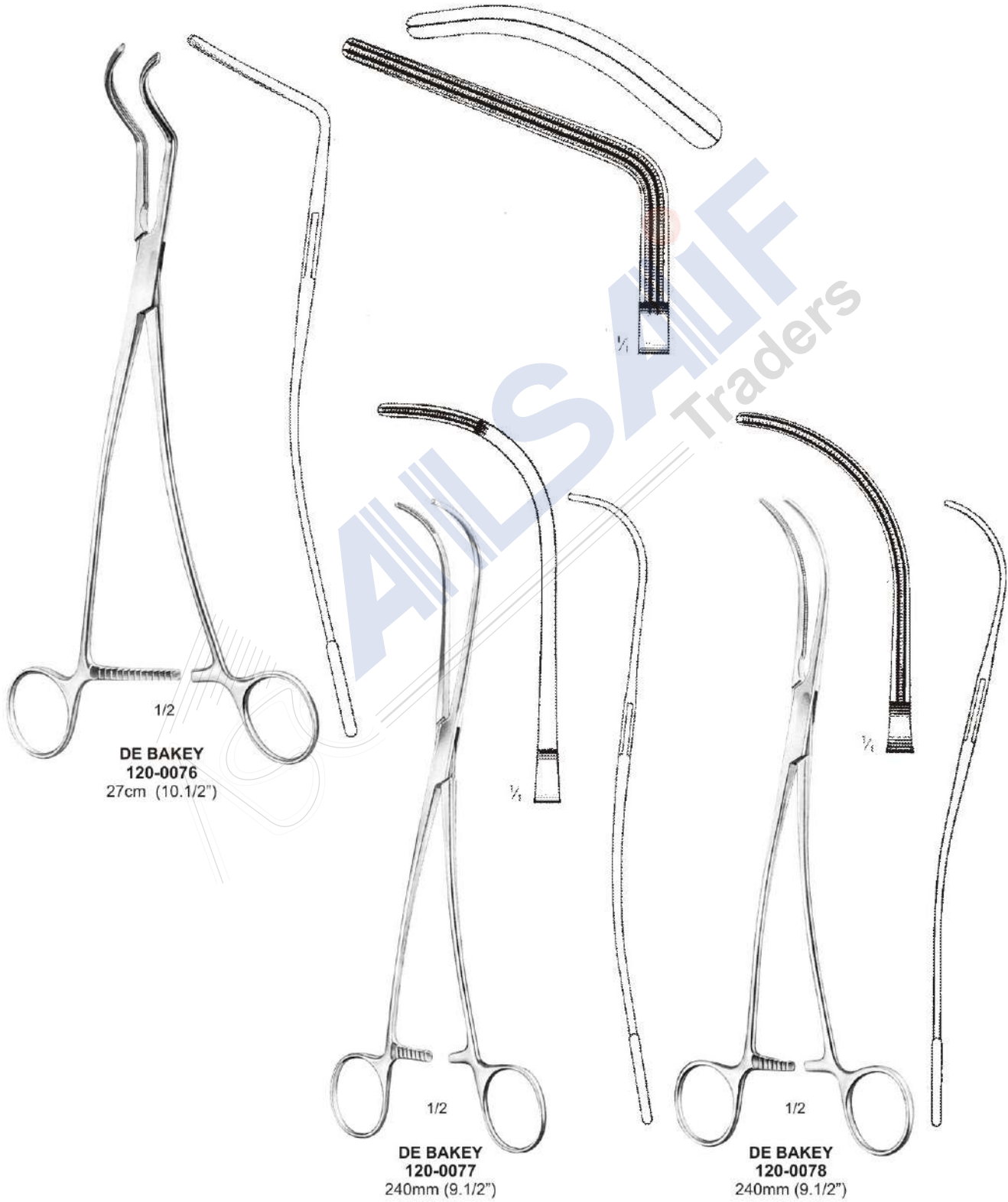

## ●●● Atrauma Cardiovascular Forceps

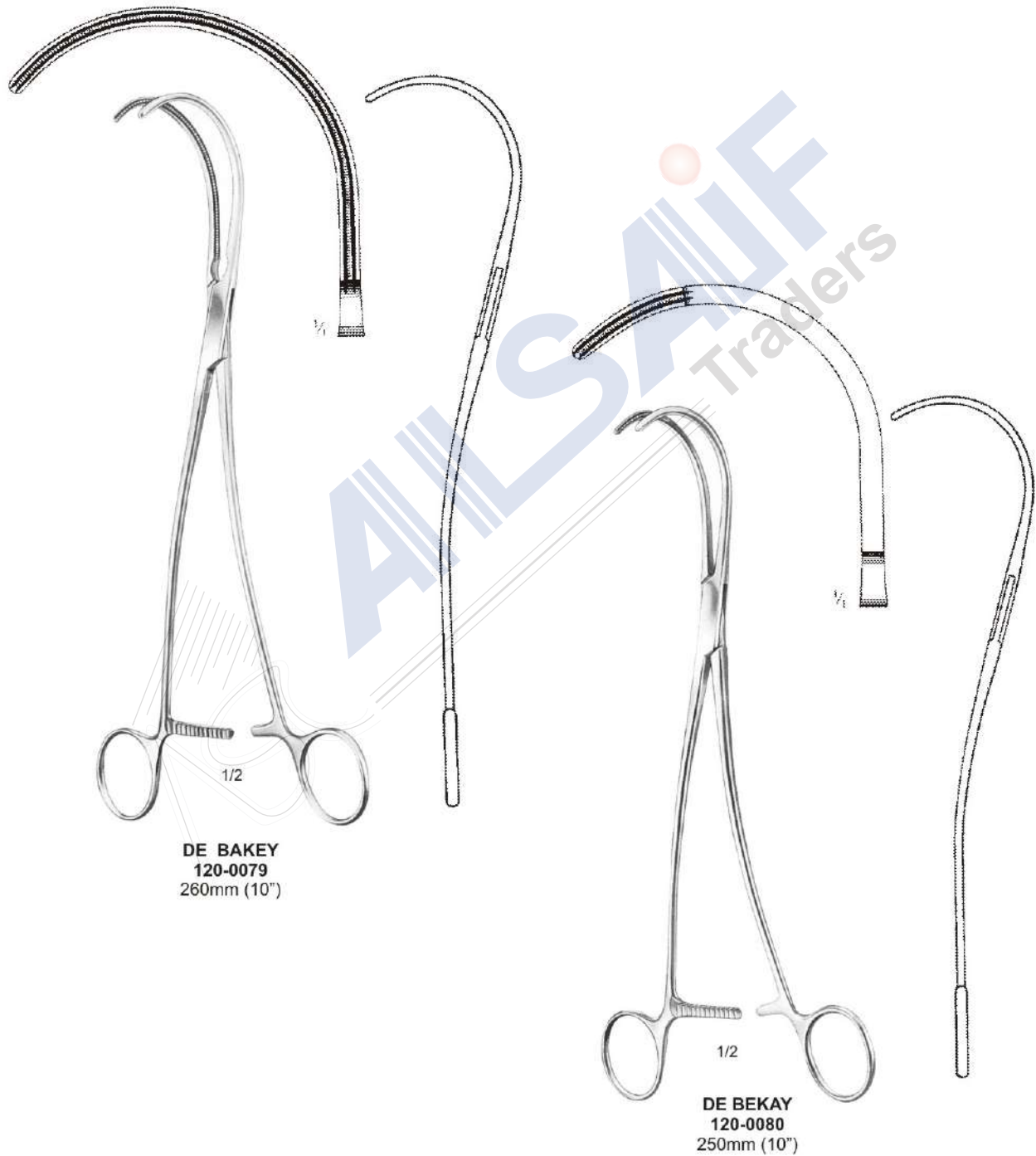

## Atrauma Cardiovascular Forceps ●●●

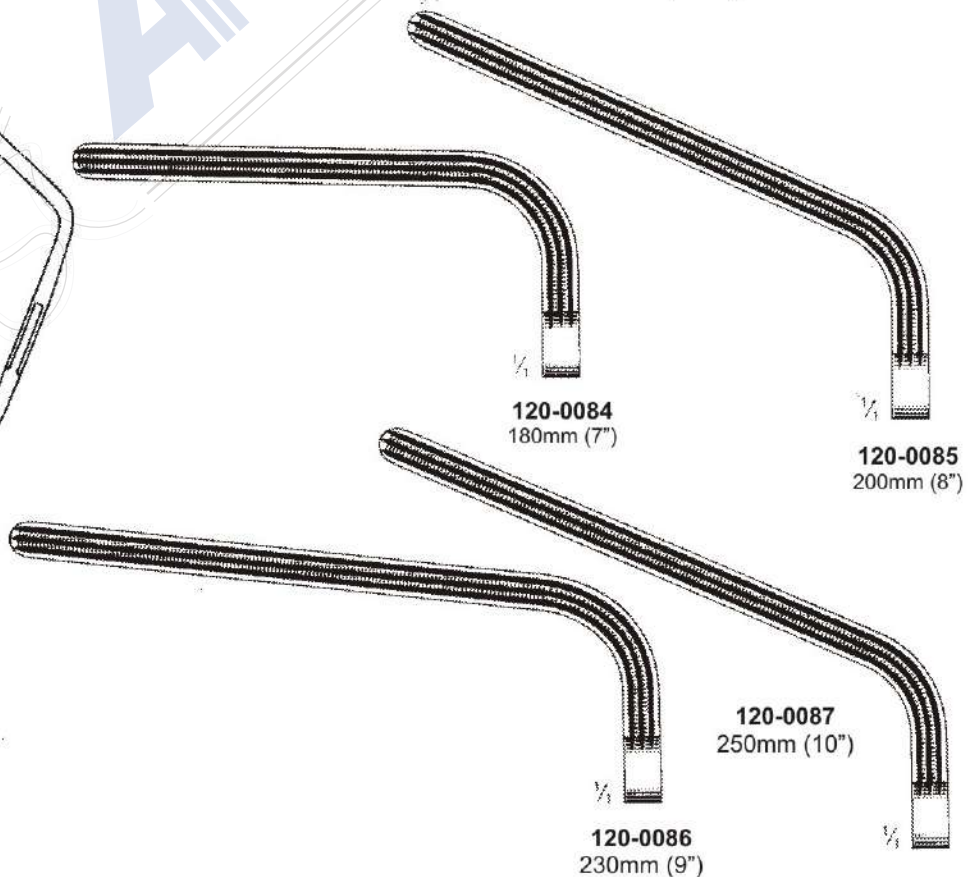
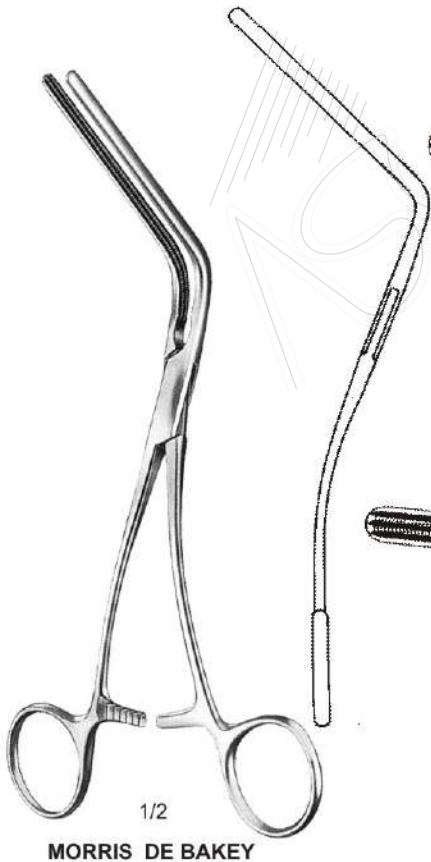
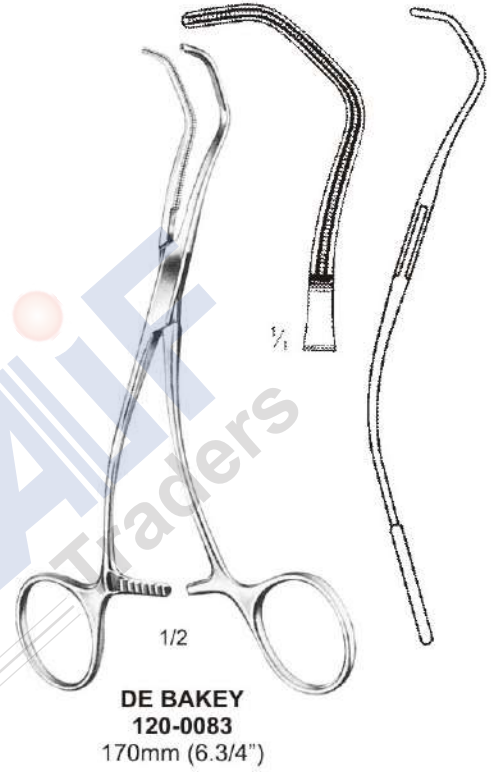
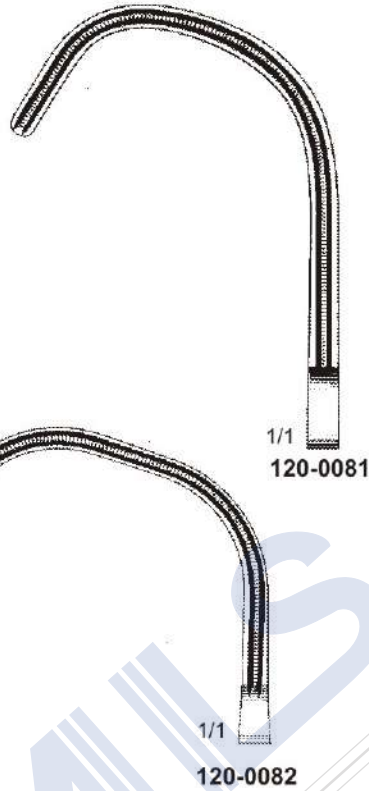

## ●●● Atrauma Cardiovascular Forceps

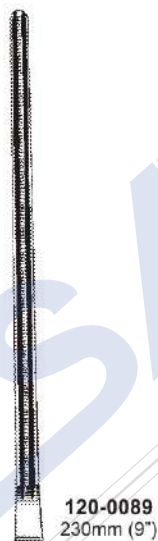
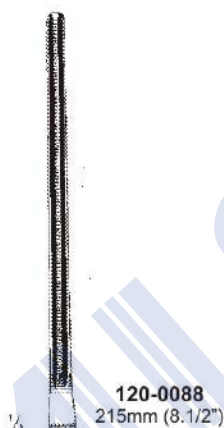



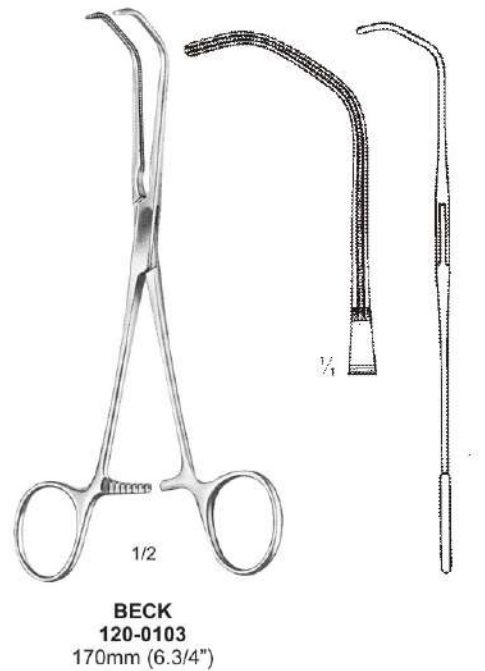
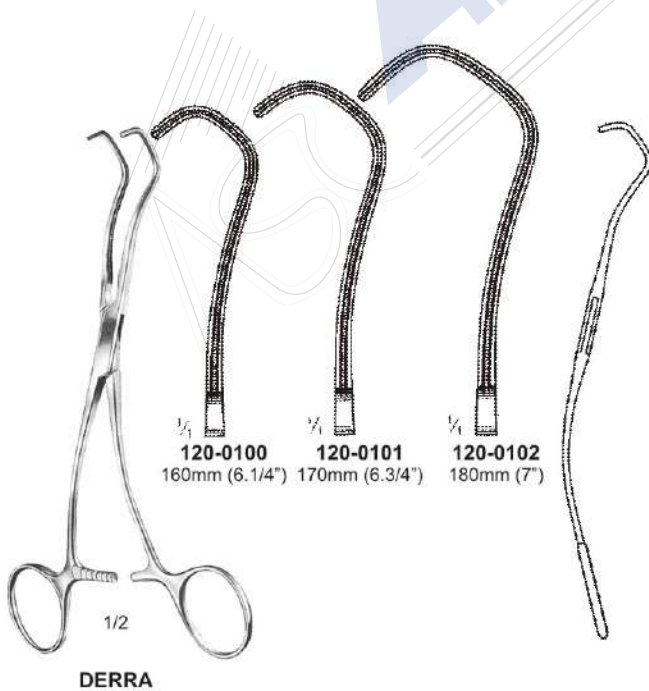
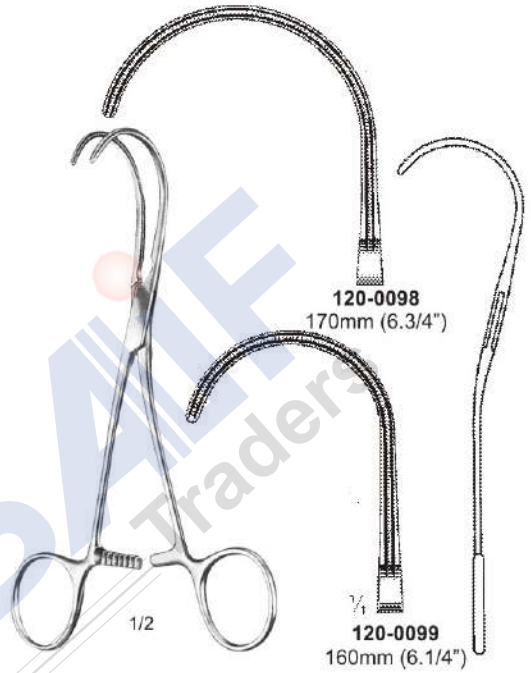
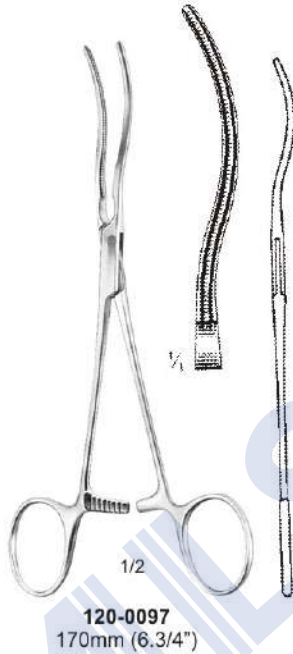
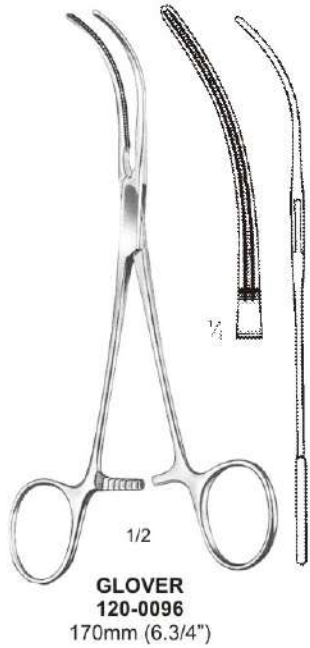

## ● ● ● Vascular Dilators

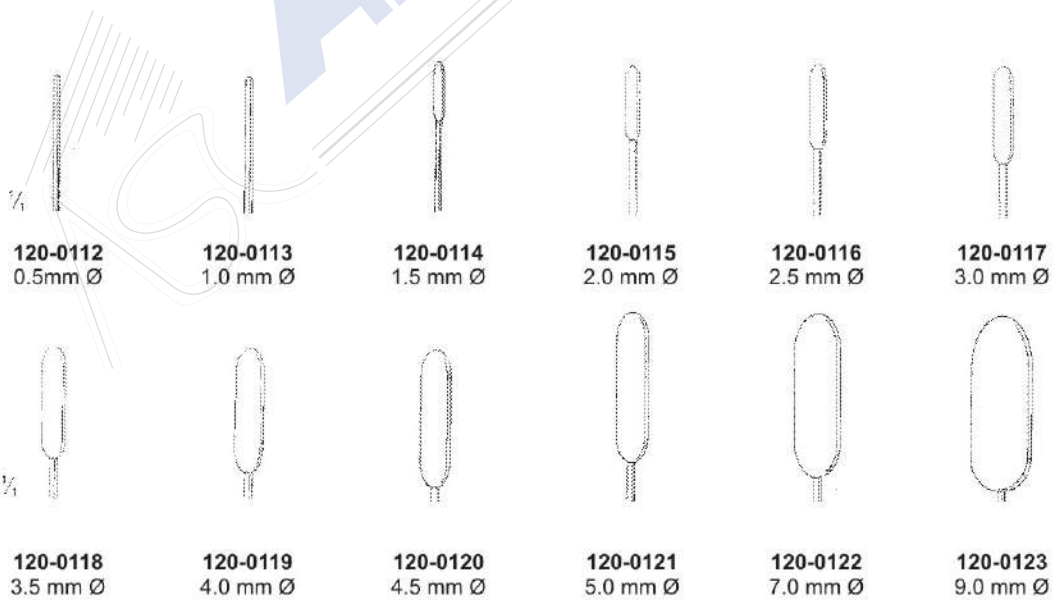
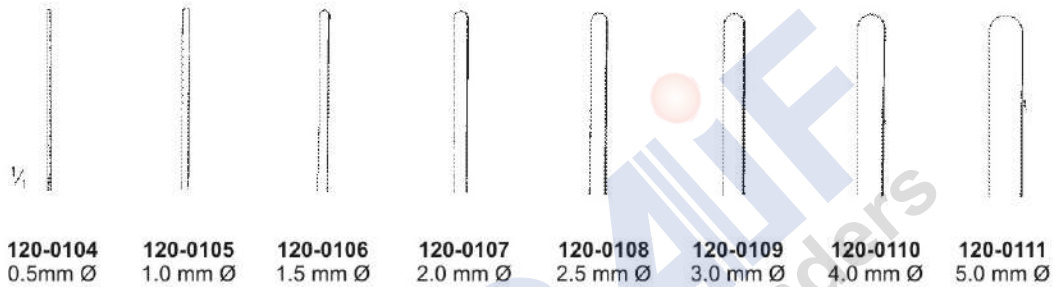



**McPHERSON**  
**121-0001**  
 70mm  
 (2.3/4")  
 Straight

**McPHERSON**  
**121-0002**  
 70mm  
 (2.3/4")  
 Angled

**JEWELER**  
**FORCEPS**  
**121-0003**  
 110 mm  
 (4.1/4")  
 Straight

**JEWELER**  
**FORCEPS**  
**121-0004**  
 110 mm  
 (4.1/4")  
 Angled

**JEWELER**  
**FORCEPS**  
**121-0005**  
 110 mm  
 (4.1/4")  
 Curved

**BIPOLAR FORCEPS**  
 Straight  
**121-0006** 150mm (6")  
**121-0007** 180mm (7")  
**121-0008** 200mm (8")  
**121-0009** 220mm (8.1/2")  
**121-0010** 240mm (9.1/2")

## ●●● Bipolar Forceps



**BIPOLAR FORCEPS  
BAYONETT**

**121-0011** 180mm (7")  
**121-0012** 200mm (8")  
**121-0013** 220mm (8.1/2")  
**121-0014** 240mm (9.1/2")

**BIPOLAR FORCEPS  
Angled downward**

**121-0015** 150mm (6")  
**121-0016** 180mm (7")  
**121-0017** 200mm (8")  
**121-0018** 220mm (8.1/2")  
**121-0019** 240mm (9.1/2")

**BIPOLAR FORCEPS  
BAYONETT**

**Angled Upward**  
**121-0020** 180mm (7")  
**121-0021** 200mm (8")  
**121-0022** 220mm (8.1/2")  
**121-0023** 240mm (9.1/2")

**BIPOLAR FORCEPS  
BAYONETT**

**Angled Downward**  
**121-0024** 180mm (7")  
**121-0025** 200mm (8")  
**121-0026** 220mm (8.1/2")  
**121-0027** 240mm (9.1/2")

## Monopolar Cables, Forceps ●●●

### MONOPOLAR CABLES

- 121-0028** 3 meter cable, Hook connector, cable with active instrument connector  
**121-0029** 5 meter cable, Hook connector, cable with active instrument connector

- 121-0030** 3 meter cable, 4mm plug, cable with active instrument connector  
**121-0031** 5 meter cable, 4mm plug, cable with active instrument connector

- 121-0032** 3 meter cable, 8mm jack plug (Bovie) cable with active instrument connector  
**121-0033** 5 meter cable, 8mm jack plug (Bovie) cable with active instrument connector

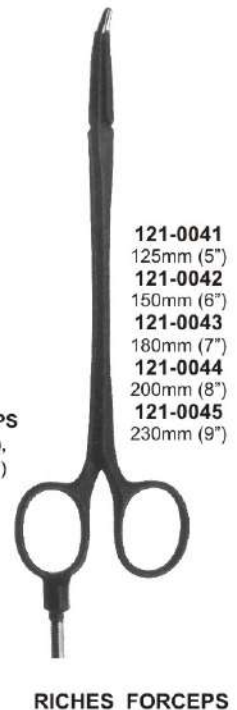
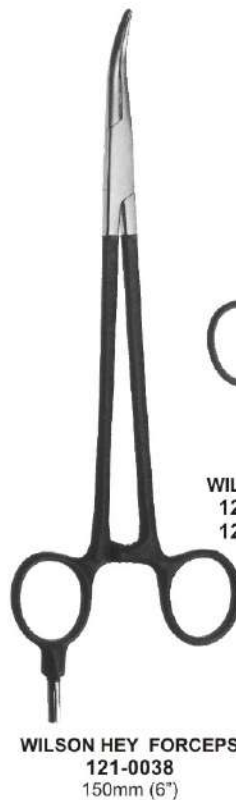

●●● Monopolar Handles, Blades, Needle, Turner W



					
<p><b>HANDLES</b> For ball and plate electrode carriers</p> <p><b>121-0046</b> 17mm (6.1/4")</p>	<p><b>HANDLES</b> For needles and loops</p> <p><b>121-0047</b> 200mm (8")</p>	<p><b>HANDLES</b> For needles and loops</p> <p><b>121-0048</b> 15mm (6")</p>	<p><b>BLADES</b></p> <p><b>121-0049</b> Large Diathermy blade electrode (Insulated)</p>	<p><b>BLADES</b></p> <p><b>121-0050</b> Large Diathermy blade electrode (Non-Insulated)</p>	<p><b>BLADES</b></p> <p><b>121-0051</b> Small Diathermy blade electrode</p>
					
<p><b>NEEDLE</b></p> <p><b>121-0052</b> Short Sharp</p>	<p><b>NEEDLE</b></p> <p><b>121-0053</b> Long Insulated</p>	<p><b>NEEDLE</b></p> <p><b>121-0054</b> Long Sharp Angled</p>	<p><b>NEEDLE</b></p> <p><b>121-0055</b> Long Sharp Straight</p>	<p><b>TURNER WARWICK SCISSOR</b></p> <p><b>121-0056</b> 125mm (5")  <b>121-0057</b> 145mm (5.1/4")  <b>121-0058</b> 150mm (6")  <b>121-0059</b> 180mm (7")  <b>121-0060</b> 230mm (9")</p>	<p><b>SCALPLE HANDLE</b></p> <p><b>121-0061</b> No3, No4</p>

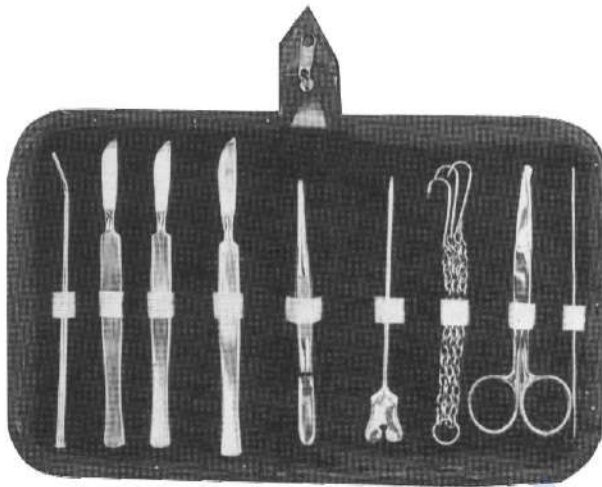

**122-0001**

- 1- BLOW PIPE
- 2- 3 PCS. SCALPEL
- 3- DISSECTING FORCEP 13 CM.
- 4- GROOVED DIRECTOR WITH TONGUE TIE 13 CM
- 5- TRIPLE CHAIN HOOK
- 6- DRESSING SCISSORS PROBE POINTED 13 CM
- 7- PROBE DOUBLE 13 CM
- 8- ZIPPER CASE INSIDE RED VELVET.



**122-0002**

- 1- PROBE DOUBLE 13 CM
- 2- 2 PCS. SCALPEL S.S.
- 3- GROOVED DIRECTOR WITH TONGUE TIE 13 CM
- 4- MAYO HEGAR NEEDLE HOLDER 13CM
- 5- DISSECTING FORCEP 13 CM 1x2 TEETH
- 6- DRESSING FORCEP 13 CMS SERRATED.
- 7- DRESSING SCISSOR 13 CM S/B STR.
- 8- DRESSING SCISSOR 13 CM S/B CVD.
- 9- ZIPPER CASE INSIDE RED VELVET.

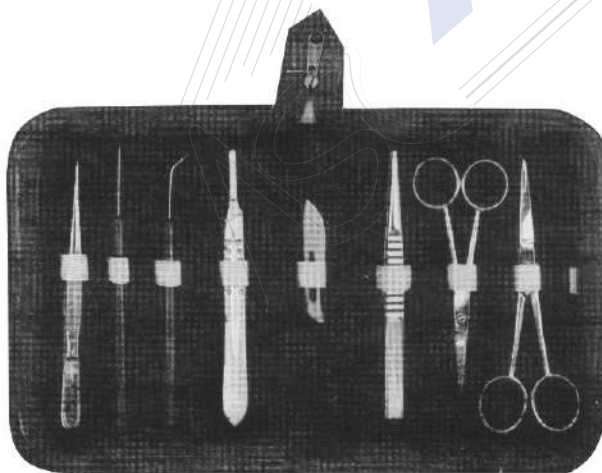

**122-0003**

- 1- DISSECTING FORCEP 11.5 CM SHARP POINT.
- 2- TEASING NEEDLE SHARP STR.
- 3- B.P HANDLE NO. 4
- 4- TEASING NEEDLE SHARP ANGULAR
- 5- BLADE NO. 22
- 6- THUMB FORCEP T.O.E. 13 CM
- 7- DISSECTING SCISSOR STR 11.5 CM
- 8- DISSECTING SCISSOR STR 13 CM
- 9- ZIPPER CASE INSIDE RED VELVET.

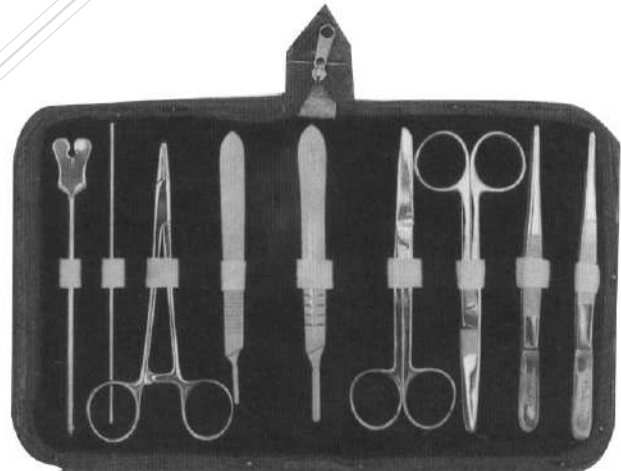

**122-0004**

- 1- GROOVED DIRECTOR WITH TONGUE TIE 14 CM
- 2- PROBE DOUBLE 14CM
- 3- MAYO HEGAR NEEDLE HOLDER 14 CM
- 4- BP. HANDLE NO.3
- 5- BP. HANDLE NO.4
- 6- DRESSING SCISSOR 14 CM S/B STR
- 7- DRESSING SCISSOR 14 CM S/B CVD.
- 8- DRESSING FORCEP 1x2 TEETH 14 CM
- 9- DRESSING FORCEP SERRATED 14 CM

## ●●● Dissection Instruments

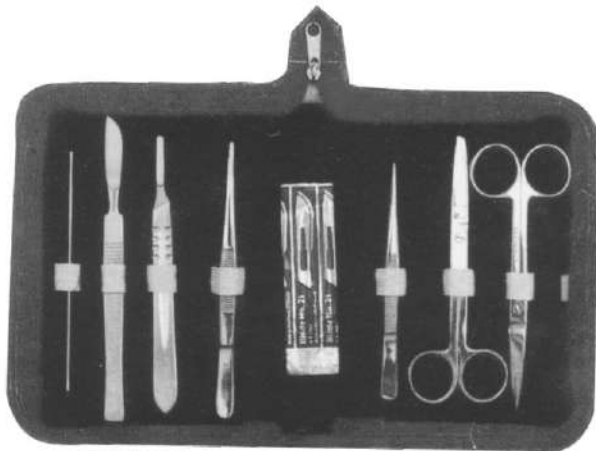

**122-0005**

- 1- PROBE DOUBLE 12.5 CM
- 2- SCALPEL.
- 3- B.P. HANDLE NO. 4
- 4- 6 PCS BLADE 2 EACH NO. 21, 22, 23
- 5- DISSECTING FORCEP 12.5 CM
- 6- DISSECTING FORCEP 11.5 CM SHARP POINT.
- 7- DRESSING SCISSOR S/B STR. 13 CM
- 8- DRESSING SCISSOR S/S STR. 13 CM

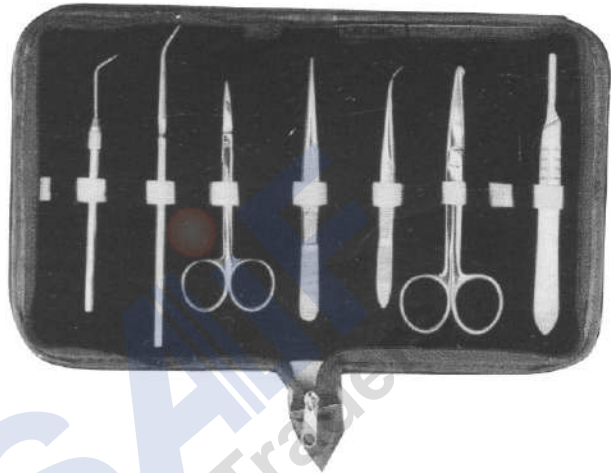

**122-0006**

- 1- TEASING NEEDLE WITH CHUCK CVD.
- 2- HUBER PROBE
- 3- IRIS SCISSOR
- 4- DISSECTING FORCEP FINE 14 CM.
- 5- DISSECTING FORCEP FINE CVD. 12 CM
- 6- OPERATING SCISSOR WITH PROBE 14 CM.
- 7- B.P. HANDLE NO. 4

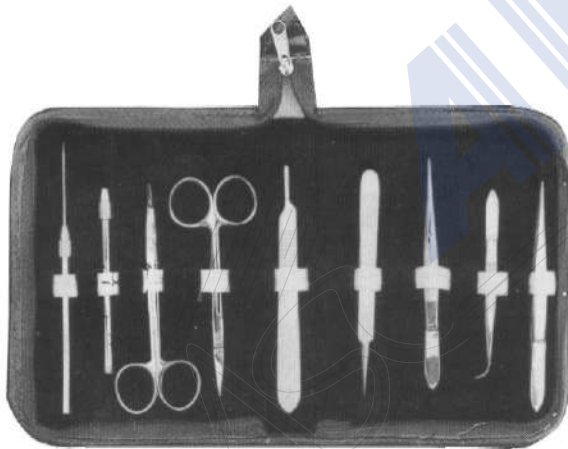

**122-0007**

- 1- DISSECTING FORCEP FINE 14 CM.
- 2- DISSECTING FORCEP FINE CVD 12 CM.
- 3- DISSECTING FORCEP WITH PIN 14 CM.
- 4- WATCHMAKER FINE POINT
- 5- IRIS SCISSOR STR
- 6- IRIS SCISSOR CVD.
- 7- TEASING NEEDLE HOLDER
- 8- TEASING NEEDLE STR.
- 9- B.P. HANDLE NO. 3



**122-0008**

- 1- TEASING NEEDLE STR.
- 2- GROOVED DIRECTOR AND TONGUE TIE.
- 3- TEASING NEEDLE CVD.
- 4- DISSECTING FORCEP WITH PIN 12 CM FINE
- 5- OPERATING SCISSOR S/B STR 14 CM
- 6- TRIPLE CHAIN HOOK
- 7- PROBE WITH EYE
- 8- PROBE DOUBLE END
- 9- PROBE AND HOOK
- 10- DISSECTING FORCEP FINE 14 CM
- 11- IRIS SCISSOR
- 12- HUBER PROBE
- 13- B.P. HANDLE NO. 3
- 14- B.P. HANDLE NO. 4





**122-0009**

- 1- PROBE WITH EYE
- 2- DISSECTING FORCEP CVD FINE 12 CM.
- 3- IRIS SCISSOR
- 4- OPERATING CCISSOR S/B STR 14 CM
- 5- GROOVED DIRECTOR AND TONGUE TIE
- 6- HUBER PROBE
- 7- TRIPLE CHAIN HOOK
- 8- B.P. HANDLE NO. 4
- 9- B.P. HANDLE NO. 3
- 10- TEASING NEEDLE WITH CHUCK CVD.
- 11- TEASING NEEDLE WITH CHUCK STR.
- 12- DISSECTING FORCEPS FINE 14 CM

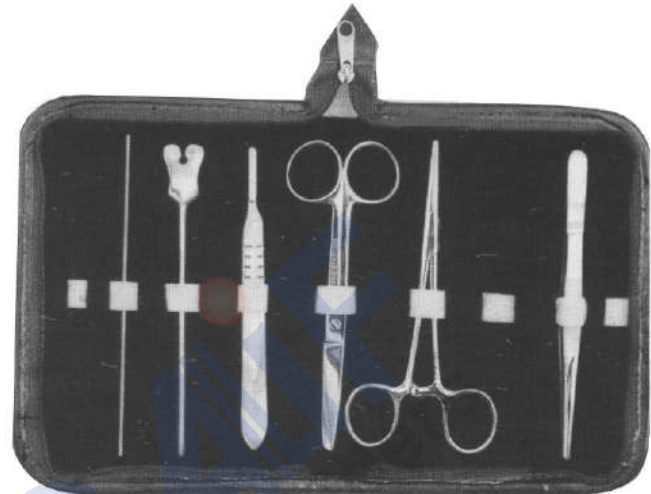

**122-0010**

- 1- PROBE DOUBLE END
- 2- GROOVED DIRECTOR AND TONGUE TIE
- 3- B.P. HANDLE NO. 4
- 4- OPERATING SCISSOR STR S/B 14 CM.
- 5- KELLY FORCEPS STR 14 CM.
- 6- DISSECTING FORCEPS THUMB 13 CM.

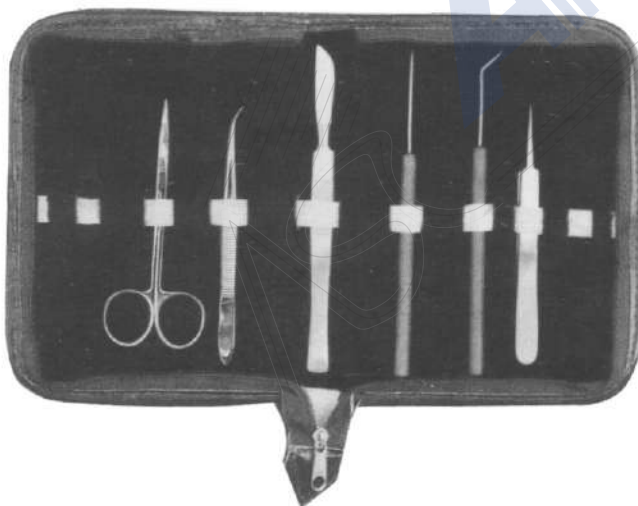

**122-0011**

- 1- IRIS SCISSOR STR
- 2- DISSECTING FORCEP CVD FINE 12 CM
- 3- SCALPEL
- 4- TEASING NEEDLE STR WOODEN HANDLE
- 5- TEASING NEEDLE CVD WOODEN HANDLE
- 6- WATCHMAKER FINE POINT



**122-0012**

- 1- DISSECTING FORCEP FINE STR WITH PIN 12 CM
- 2- IRIS SCISSOR STR
- 3- PROBE WITH EYE
- 4- PROBE AND HOOK
- 5- OPERATING SCISSOR S/B STR 14 CM
- 6- TRIPLE CHAIN HOOK
- 7- B.P. HANDLE NO. 4
- 8- HUBER PROBE
- 9- B.P. HANDLE NO. 3
- 10- TASING NEEDLE STR PLASTIC HANDLE
- 11- TASING NEEDLE CVD PLASTIC HANDLE
- 12- GROOVED DIRECTOR AND TONGUE TIE
- 13- PROBE DOUBLE END

## ●●● Dissection Instruments

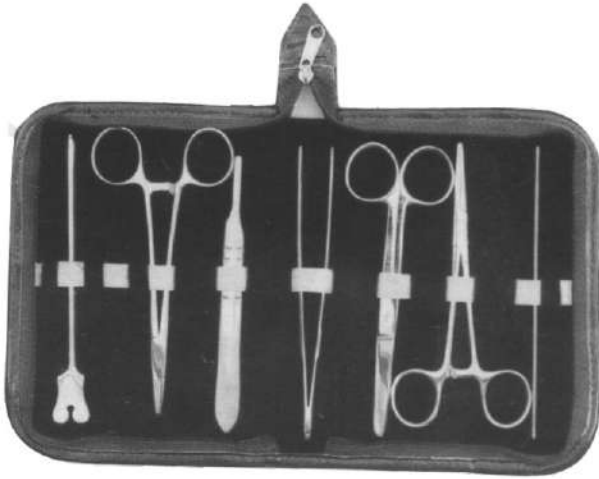

### 122-0013

- 1- GROOVED DIRECTOR AND TONGUE TIE
- 2- MAYO HEGAR NEEDLE HOLDER 14 CM.
- 3- BP. HANDLE NO.4
- 4- DISSECTING FORCEP THUMB 14 CM.
- 5- OPERATING SCISSOR S/B STR 14 CM.
- 6- KELLY FORCEP 14 CM STR
- 7- PROBE DOUBLE END



### 122-0014

- 1- DISSECTING FORCEP THUMB 14 CM
- 2- DISSECTING FORCEP 1x2 TEETH 14 CM
- 3- BP. HANDLE NO. 3
- 4- GROOVED DIRECTOR AND TONGUE TIE
- 5- MAYO HEAGR NEEDLE HOLDER 14 CM.
- 6- OPERATING SCISSOR S/B STR 14 CM.
- 7- PROBE DOUBLE END
- 8- KELLY FORCEP STR 14 CM.

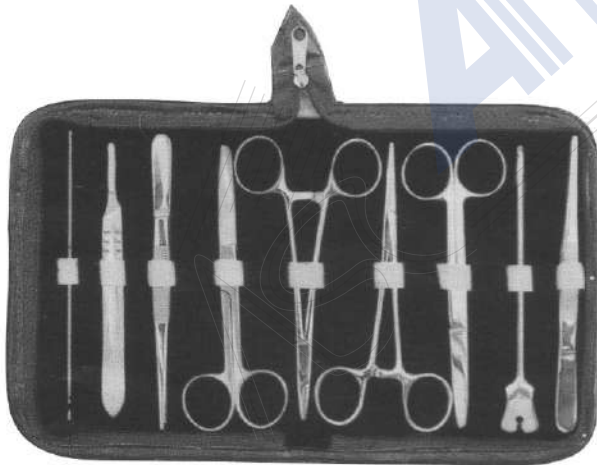

### 122-0015

- 1- PROBE DOUBLE END
- 2- B.P. HANDLE NO. 4
- 3- DISSECTING FORCEP 1x2 TEETH 14 CM.
- 4- OPERATING SCISSOR S/B 14 CM STR.
- 5- MAYO HEAGR NEEDLE HOLDER 14 CM.
- 6- KELLY FORCEP STR 14 CM.
- 7- OPERATING SCISSOR S/B CVD 14 CM.
- 8- GROOVED DIRECTOR AND TONGUE TIE
- 9- DISSECTING FORCEP THUMB 14 CM.



### 122-0016

- 1- PROBE DOUBLE END
- 2- DISSECTING FORCEP 1x2 TEETH 14 CM.
- 3- KELLY FORCEP CVD 14 CM.
- 4- OPERATING SCISSOR S/B 14 CM CVD.
- 5- MAYO HEAGR NEEDLE HOLDER 14 CM.
- 6- B.P. HANDLE NO.4
- 7- OPERATING SCISSOR S/B 14 CM STR.
- 8- KELLY FORCEP STR. 14 CM.
- 9- DISSECTING FORCEP THUMB 14 CM
- 10- GROOVED DIRECTOR AND TONGUE TIE

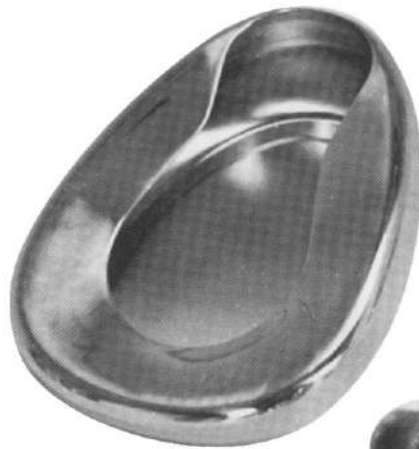

123-0001



123-0002



123-0008



123-0007

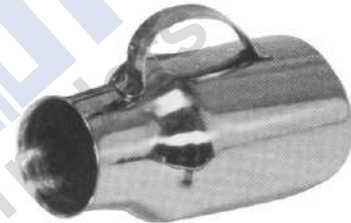

123-0006



123-0004



123-0003  
123-0005

**BED PANS, Perfection Type**

INSTRUMENTS #		LENGTH		WIDTH		FRONT	HEIGHT	BACK	
123-0001	Adult	14"	355mm	11-3/8"	290mm	4-3/8"	110mm	2-5/8"	67mm
123-0002	Child	12-1/8"	308mm	9-3/4"	80mm	3-1/8"	80mm	1-3/4"	45mm

**BED PANS, Practure Type**

123-0003		11-7/8"	300mm	9-1/4"	235mm	2-7/8"	72mm	1"	25mm
123-0004		Same as above but with cover							
123-0005	Large	14-1/8"	360mm	10"	255mm	3- 1/8"	90mm	1"	25mm

**URINALS MALE**

		CAPACITY			DIAMETER		HEIGHT	
123-0006	Horizontal	1-3/4" Qts.	1.7" Qts.	4-1/2"	115mm	9-1/2"	240mm	
123-0007	Upright Junior	1.0 Qts.	0.9 Qts.	3-3/4"	95mm	8"	203mm	
123-0008	Upright Adult	1.5/8 Qts.	1.5 Qts.	4"	100mm	8-7/8"	225mm	

## ●●● Patient Treatment Items

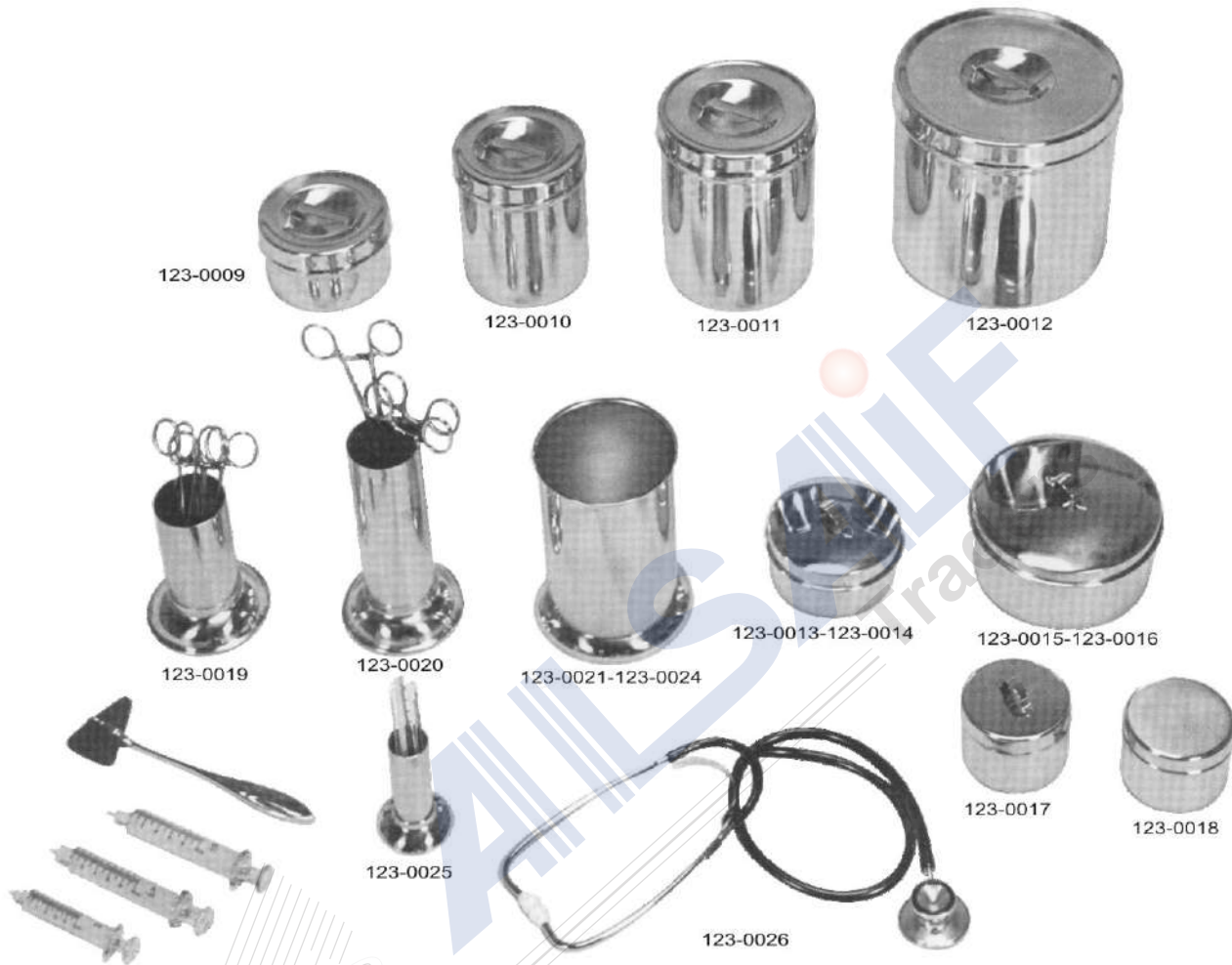

### PATIENT TREATMENT ITEMS

#### DRESSING JARS w/cover

CAT. No.	Capacity	Diameter	Height
123-0009	½ Qt. 0.47l	4-1/8" 105mm	2-3/8" 60mm
123-0010	1Qt. 0.95l	4-1/8" 105mm	5-1/4" 135mm
123-0011	2-1/4 Qts. 2.13l	4-7/8" 125mm	6-3/4" 170mm
123-0012	4-½ Qts. 4.26l	7-1/4" 185mm	6-7/8" 175mm
123-0013	5/16 Qt. 0.32l	3-1/2" 90mm	2-1/8" 55mm
123-0014	7/16 Qt. 0.4l	4" 100mm	2-1/4" 57mm
123-0015	11/16 Qt. 0.67l	4-3/4" 120mm	2-3/8" 61mm
123-0016	1-1/16 Qts. 1.0l	5-1/2" 140mm	3" 75mm

#### NEEDLE/OINTMENT JARS w/cover

123-0017	1/4 Qt. 0.24l	3" 75mm	2-1/2" 65mm
123-0018 - Same as above but with plain cover-			

#### FORCEPS JARS w/Heavy base and Light base

CAT. No.	Tube Diameter	Base Diameter	Height
123-0019 Heavy base	2-1/8" 55mm	4" 100mm	4-1/2" 115mm
123-0020 Heavy base	2-1/8" 55mm	4" 100mm	7-1/4" 185mm
123-0021 Light base	2-3/8" 60mm	3-1/8" 80mm	4" 100mm
123-0022 Light base	3" 75mm	3-3/4" 95mm	4-3/4" 120mm
123-0023 Light base	3-1/28" 90mm	4-1/2" 115mm	6-1/8" 155mm
123-0024 Light base	4" 100mm	4-7/8" 125mm	6-3/4" 170mm

#### THERMOMETER JAR

123-0025	1" 25mm	2-1/8" 55mm	4" 100mm
----------	---------	-------------	----------

#### STETHOSCOPES

123-0026	Combination Stethoscope chest piece turnable, light meta, one side with diaphragm, other side bell type	Chest piece only, ø 47mm
----------	---	--------------------------

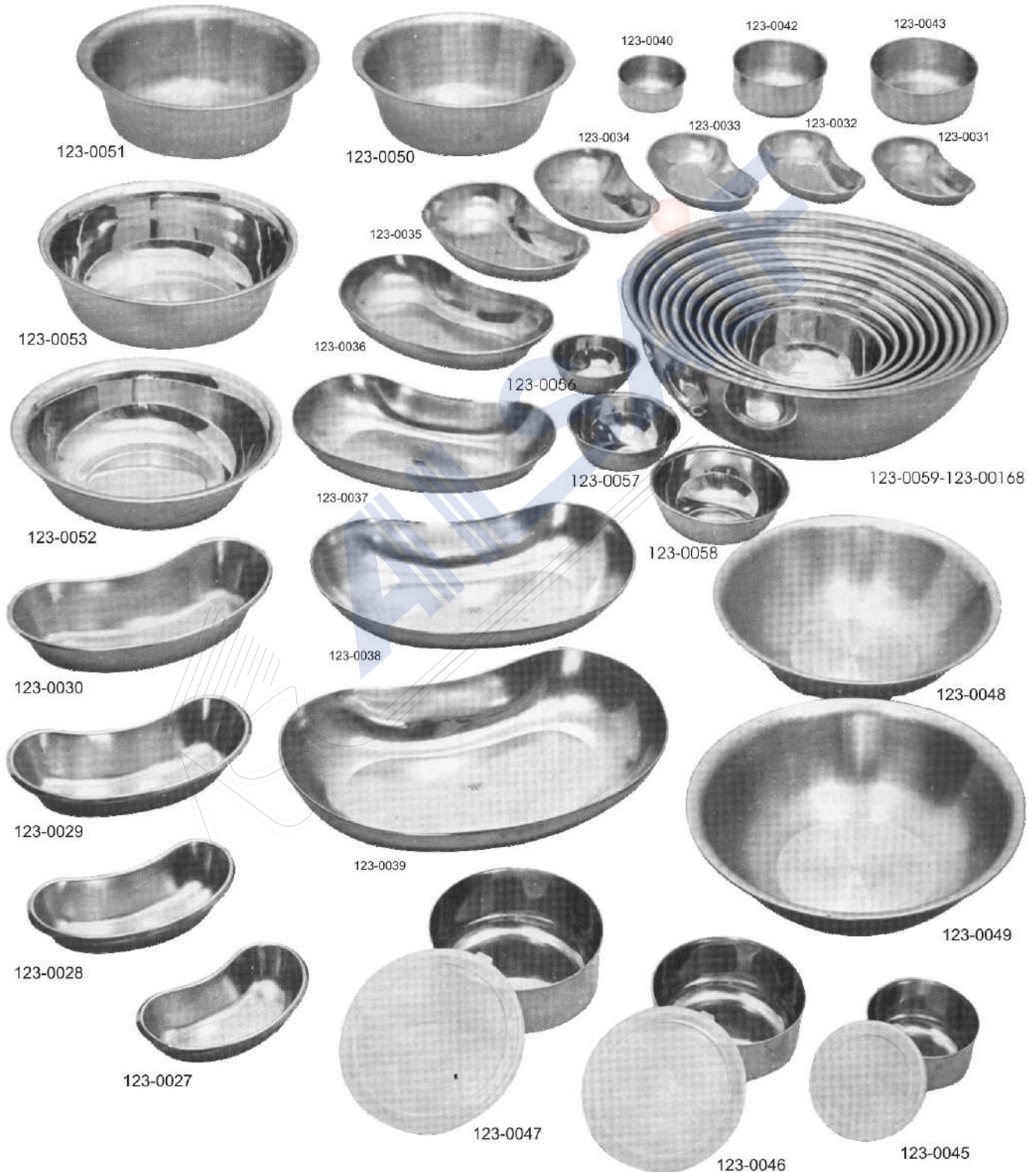

## ●●● Treatment Room Items

### **EMESIS BASINS (Kidney trays), deep**

INSTRUMENTS #	LENGTH		WIDTH		DEPTH	
123-0027	6"	150mm	3-1/2"	90mm	1-1/2"	40mm
123-0028	8"	205mm	3-3/4"	95mm	1-3/4"	45mm
123-0029	10"	255mm	4-1/2"	115mm	2-1/8"	55mm
123-0030	12"	305mm	5-1/2"	140mm	2-1/2"	65mm

### **EMESIS BASINS (Kidney Trays), shallow, light gauge**

123-0031	7-7/8"	200mm	4-3/8"	110mm	1-1/4"	30mm
123-0032	8-1/2"	215mm	4-1/2"	115mm	1-3/8"	35mm
123-0033	9"	230mm	5"	125mm	1-3/8"	35mm
123-0034	9-5/8"	245mm	5-1/2"	140mm	1-5/8"	40mm
123-0035	11-1/4"	285mm	6-1/4"	160mm	1-3/4"	45mm
123-0036	12-3/8"	315mm	6-7/8"	175mm	2"	50mm
123-0037	13"	330mm	7-1/4"	185mm	2-1/8"	55mm
123-0038	14-5/8"	370mm	8-1/2"	215mm	2-3/8"	60mm
123-0039	16-1/8"	410mm	9-5/8"	245mm	2-1/2"	65mm

### **SPONGE BOWLS**

INSTRUMENTS #	CAPACITY		DIAMETER		DEPTH	
123-0040	3/8 Qt.	0.36	4-1/8"	105mm	2"	50mm
123-0041	5/8 Qt.	0.6	5"	125mm	2-1/4"	57mm
123-0042	1.0 Qt.	0.95	5-3/4"	145mm	2-1/2"	65mm
123-0043	1-3/8 Qts.	1.3	6-1/2"	165mm	3"	75mm
123-0044	1-7/8 Qts.	1.78	7-3/8"	187mm	3"	75mm

### **SPONGE BOWLS w/plastic cover 18.0 s.s.**

123-0045	3/8 Qt.	0.36	4"	100mm	2-1/8"	55mm
123-0046	7/8 Qt.	0.8	5-1/2"	140mm	2-1/2"	65mm
123-0047	1-3/8 Qts.	1.3	6-1/2"	165mm	2-3/4"	70mm

### **WASH BASINS**

123-0048	3-7/8 Qts.	3.7	12-3/8"	315mm	3-1/8"	80mm
123-0049	4-3/4 Qts.	4.5	13-1/4"	335mm	3-5/8"	90mm

### **SOLUTION BASINS**

123-0050	7 Qts.	6.6	13-5/8"	345mm	4-5/8"	115mm
123-0051	8-1/2 Qts.	8.0	14-1/2"	370mm	4-3/4"	120mm
123-0052	4-1/2 Qts.	4.2	12-5/8"	320mm	3-1/8"	80mm
123-0053	5-3/4 Qts.	5.4	12-5/8"	320mm	4-1/8"	105mm
123-0054	6-1/2 Qts.	6.2	13-3/8"	340mm	4-3/8"	110mm
123-0055	8 Qts.	7.6	14-1/8"	360mm	4-5/8"	118mm

### **LOTION BOWLS, 18.8 s.s. or 18.0 s.s.**

123-0056	1/4 Qt.	0.24	4-1/8"	105mm	1-3/4"	45mm	
123-0057	7/16 Qt.	0.4	5-1/8"	130mm	2-1/8"	55mm	
123-0058	3/4 Qt.	0.7	5-7/8"	150mm	2-3/8"	60mm	
123-0059	1-1/4 Qts.	1.2	7-1/8"	180mm	2-3/4"	70mm	
123-0060	2-1/8 Qts.	2.0	8-1/4"	210mm	3-1/2"	90mm	
123-0061	3-3/16 Qts.	3.0	9-1/2"	240mm	4"	100mm	
123-0062	3-3/4 Qts.	4.5	10-5/8"	270mm	4-1/8"	105mm	
123-0063	6-7/8 Qts.	6.5	11-3/4"	300mm	4-3/4"	120mm	
123-0064	8-7/16 Qts.	8.0	13"	330mm	4-7/8"	125mm	
123-0065	10 Qts.	9.5	14-1/8"	360mm	5-1/4"	135mm	
123-0066	13-1/8 Qts.	12.5	15-3/8"	390mm	5-3/4"	145mm	
123-0067	15-5/16 Qts.	15.5	16-1/2"	420mm	6-1/8"	155mm	
123-0068	21-1/8 Qts.	20.0	17-3/4"	450mm	6-3/4"	170mm	
123-0069	Deep not Illustratea	1-3/16 Qts.	1.1	6-1/4"	150mm	3-3/8"	85mm
123-0070	Deep not Illustratea	1-5/16 Qts.	1.8	7-1/8"	180mm	4"	100mm
123-0071	Deep not Illustratea	3-1/8 Qts.	3.0	8-1/4"	210mm	4-1/2"	115mm
123-0072	Deep not Illustratea	4-7/16 Qts.	4.2	9-1/2"	240mm	5-1/8"	130mm



## ●●● Treatment Room Items

### TREATMENT ROOM ITEMS

#### CATHETER TRAYS w/cover

CAT. No.	Length	Width	Depth
123-0073	8-3/4" 222mm	3-1/4" 82mm	1-5/8" 40mm
123-0074	8-1/2" 215mm	3" 75mm	1-1/2" 38mm
123-0075	8-7/8" 225mm	5" 125mm	2" 50mm
123-0076	17" 430mm	4" 100mm	2-1/8" 55mm

#### INSTRUMENT TRAYS

123-0077	8-7/8" 225mm	5" 125mm	2" 50mm
123-0078	12-1/4" 310mm	7-5/8" 195mm	2-1/8" 55mm
123-0079 w/cover	- Same as above -		
123-0080	12-5/8" 320mm	9" 320mm	1-3/4" 45mm
123-0081	14-1/8" 360mm	10-5/8" 270mm	2" 50mm
123-0082	16-1/8" 410mm	11-3/8" 290mm	2-1/8" 55mm

#### INSTRUMENT TRAYS, Shallow

123-0083	13-1/2" 345mm	9-3/4" 245mm	5/8" 16mm
123-0084	15-1/8" 385mm	10-1/2" 265mm	5/8" 16mm
123-0085	17" 340mm	11-5/8" 295mm	5/8" 16mm
123-0086	19" 485mm	12-1/2" 320mm	5/8" 16mm

#### INSTRUMENT TRAYS w/set cover

123-0087	8-1/4" 210mm	6" 150mm	1-5/8" 40mm
123-0088	9-1/2" 240mm	7-1/8" 180mm	1-5/8" 40mm
123-0089	9-1/2" 240mm	7-1/8" 180mm	2-3/8" 60mm
123-0090	10-5/8" 270mm	8-1/4" 210mm	1-5/8" 40mm
123-0091	10-5/8" 270mm	8-1/4" 210mm	2-3/8" 60mm
123-0092	11-7/8" 300mm	9-1/2" 240mm	1-5/8" 40mm
123-0093	11-7/8" 300mm	9-1/2" 240mm	2-3/8" 60mm
123-0094	13" 330mm	10-5/8" 270mm	1-5/8" 40mm
123-0095	13" 330mm	10-5/8" 270mm	2-3/8" 60mm
123-0096	14-1/8" 360mm	11-7/8" 300mm	1-5/8" 40mm
123-0097	14-1/8" 360mm	11-7/8" 300mm	2-3/8" 60mm

#### INSTRUMENT TRAYS w/tab handle

123-0098	14-7/8" 375mm	10-1/8" 255mm	2" 50mm
123-0099	16-1/8" 410mm	11-1/8" 280mm	2" 50mm

#### STERILIZING TRAYS

123-0100 Syringe	5-1/4" 135mm	4" 100mm	1" 25mm
123-0101 Needle	8-1/2" 215mm	4-1/2" 115mm	3/8" 10mm

#### STERILIZERS, INSTRUMENTS, for fuel heat, including container, perforated lift-out tray and flat cover.

123-0102	12-5/8" 320mm	6-7/8" 175mm	4" 100mm
123-0103	16-3/8" 415mm	9-7/8" 250mm	4" 100mm
123-0104	17-3/4" 450mm	10-5/8" 270mm	7-1/8" 180mm



## INDEX

### A

<b>American Pattern</b> (Scissors)	10
<b>Aufricht</b> (Scissors)	10
<b>Adson</b> (Delicate Dissecting Forceps)	17,8
<b>Adson-brown</b> (Delicate Dissecting Forceps)	8
<b>Arthure</b> (Splinter Forceps)	22
<b>Adson-brown</b> (Delicate Dissecting Forceps)	18
<b>Arthure</b> (Splinter Forceps)	22
<b>Allis</b> (Tissue Forceps)	26
<b>American Pattern Allis</b> (Tissue Forceps)	26
<b>Arruga</b> (Micro)	43
<b>Anel Lachrymal</b> (Probes)	49
<b>Auward</b> (Vaginal Retractor)	75
<b>Alexander</b> (Cervical Biopsy Forceps)	81
<b>Adson Frazier</b> (Suction Tubes)	95
<b>Adson</b> (Suction Tubes)	95
<b>Amputation Saw</b> (Amputation Instruments)	96
<b>Army Regulation Amputation Saw</b> (Amputation Instruments)	96
<b>Adson</b> (Bone Levers & Raspatories)	98
<b>Aneurysm Clamp</b> (Atrauma Cardiovascular Forceps)	122

### B

<b>Barron</b> (Surgical Handles)	05
<b>Braun Stadler</b> (Scissors)	10
<b>Bonney</b> (Serrated Dissecting Forceps)	16
<b>Bickford</b> (Serrated Dissecting Forceps)	16
<b>Bonney</b> (Toothed Dissecting Forceps)	20
<b>Bickford</b> (Toothed Dissecting Forceps)	20
<b>Baby - Adson</b> (Dissecting & Ligature Forceps)	23
<b>Babcock</b> (Tissue Forceps)	25
<b>Ball And Socket</b> (Towel Clamps)	29
<b>Backhaus</b> (Towel Clamps)	29
<b>Bozemann Uterine</b> (Dressing Forceps)	31
<b>Bozemann</b> (Dressing Forceps)	31
<b>Baby - Crile</b> (Haemostats Forceps)	32,33
<b>Birkett</b> (Haemostats Forceps)	40
<b>Barraquer</b> (Micro)	43
<b>Brodie</b> (Probes)	48
<b>Balfour Abdominal</b> (Hand Held Retractors)	60
<b>Berkeley Abdominal</b> (Hand Held Retractors)	62
<b>Brown</b> (Tenaculum Forceps)	78
<b>Bonney Polypi</b> (Ovum Forceps)	80
<b>Bumm</b> (Uterine Cannulae)	85
<b>Bonney</b> (Hysterectomy Clamps)	90
<b>Bladder Spatula</b> (Urology)	92
<b>Barron</b> (Suction Tubes)	95
<b>Belucci</b> (Suction Tubes)	95
<b>Boyd Bone Curette</b> (Bone Levers & Raspatories)	98
<b>Burns</b> (Bone Holding Forceps)	101
<b>Beyer</b> (Bone Rongeurs)	103
<b>Beyer</b> (Bone Rongeurs)	105
<b>Beck Rongeur</b> (Disc Rongeurs)	107
<b>Burford</b> (Rib Spreaders)	111
<b>Bainbridge</b> (Atrauma Cardiovascular Forceps)	121
<b>Beck</b> (Atrauma Cardiovascular Forceps)	127
<b>Bipolar Forceps</b> (Bipolar Forceps)	129,130
<b>Blades</b>	132
(Monopolar Handles, Blades, Needle, Turner Warwick Scissors)	

### C

<b>Crafoord</b> (Scissors)	09
<b>Counter Scissors</b> (Scissors)	13
<b>Canadian</b> (Serrated Dissecting Forceps)	15
<b>Cairns Dott</b> (Delicate Dissecting Forceps)	17
<b>Canadian</b> (Toothed Dissecting Forceps)	20
<b>Chaput Poirier</b> (Tissue Forceps)	26

<b>Collin Tongue Forceps</b> (Tongue Depressors)	28
<b>Cushing</b> (Haemostats Forceps)	34
<b>Crafoord</b> (Haemostats Forceps)	34
<b>Cairns</b> (Haemostats Forceps)	34
<b>Crile</b> (Haemostats Forceps)	34,35
<b>Castroviejo</b> (Micro)	43
<b>Converse</b> (Needle Holders)	43
<b>Crile Wood</b> (Needle Holders)	44
<b>Crile Murray</b> (Needle Holders)	44
<b>Cawthorne</b> (Probes)	49
<b>Charnley Suture</b> (Suture Instruments)	51
<b>Cushings Vein</b> (Hand Held Retractors)	57
<b>Cone</b> (Hand Held Retractors)	64
<b>Cusso</b> (Vaginal Speculum)	72
<b>Czerny Rectal Speculum</b> (Proctology)	91
<b>Clutton Urethral Sounds</b> (Urology)	93
<b>Cone Suction Tubes</b> (Suction Tubes)	95
<b>Collier And Morris</b> (Bone Scoops)	99
<b>Cairns</b> (Bone Rongeurs)	103
<b>Cushing Cairns</b> (Disc Rongeurs)	107
<b>Cushing Rongeur</b> (Disc Rongeurs)	107
<b>Cooley</b> (Rib Spreaders)	110
<b>Cooley</b> (Atrauma Cardiovascular Forceps)	117
<b>Cooley</b> (Atrauma Tissue Forceps)	118
<b>Cooley</b> (Vascular Dilators)	128

### D

<b>Dressing</b> (Scissors)	08
<b>Doyen Abdominal</b> (Scissors)	13
<b>Dissecting Forceps</b> (Serrated Dissecting Forceps)	15
<b>Dissecting Forceps</b> (Delicate Dissecting Forceps)	18
<b>Dissecting Forceps</b> (Toothed Dissecting Forceps)	19
<b>Denis Browne</b> (Splinter Forceps)	22
<b>Doyen Child</b> (Mouth Gags)	27
<b>Doyen Dult</b> (Mouth Gags)	27
<b>Doyen</b> (Towel Clamps)	29
<b>Dunhill</b> (Haemostats Forceps)	37
<b>Derf</b> (Needle Holders)	43
<b>Directors</b> (Probes)	48
<b>Deaver</b> (Hand Held Retractors)	52
<b>Deaver Grip</b> (Hand Held Retractors)	53
<b>Durham</b> (Hand Held Retractors)	56
<b>Doyen</b> (Hand Held Retractors)	59
<b>Doyen</b> (Intestinal Clamps)	67
<b>Doyen Kocher</b> (Intestinal Clamps)	68
<b>Doyen Mayo Robson</b> (Intestinal Clamps)	68,69
<b>Doyen</b> (Vaginal Speculum)	74
<b>Doyen</b> (Ovum Forceps)	80
<b>De Lee</b> (Obstetrics Instruments)	86
<b>Dingman</b> (Bone Holding Forceps)	102
<b>De Vilbiss</b> (Bone Cutting Forceps)	108
<b>De-bakey Satinsky</b> (Atrauma Bulldog Clamps)	113
<b>De Bakey-carotis</b> (Atrauma Bulldog Clamps)	113
<b>De Bakey Satinsky</b> (Atrauma Bulldog Clamps)	113
<b>Debakey Bulldog</b> (Atrauma Bulldog Clamps)	113
<b>Debakey Bulldog Clamps</b> (Atrauma Bulldog Clamps)	113
<b>De Bakey-rankin</b> (Atrauma Hemostatic)	114
<b>De Bakey-mosquito</b> (Atrauma Hemostatic)	114
<b>Dietrich</b> (Cardiovascular Forceps)	114
<b>Dale</b> (Atrauma Cardiovascular Forceps)	115
<b>De Bakey</b> (Atrauma Tissue Forceps)	118
<b>De Bakey</b> (Atrauma Cardiovascular Forceps)	120,121,123,124,125
<b>De Bakey</b> (Vascular Dilators)	128
<b>Dissecting Forceps</b> (Monopolar Cables)	131
<b>Derra</b> (Atrauma Cardiovascular Forceps)	127
<b>Dissection Sets</b> (Dissection Instruments)	133,134,135,136

## INDEX

### E

<b>Ent Complete</b> (Diagnostic Set)	01
<b>Ergonomic</b> (Surgical Handles)	04
<b>Emmet</b> (Serrated Dissecting Forceps)	16
<b>Edna Lorna</b> (Towel Clamps)	29
<b>Elliot</b> (Obstetrics Instruments)	86
<b>Echlin</b> (Bone Rongeurs)	105

### F

<b>Favaloro</b> (Scissors)	13
<b>Feilchenfel</b> (Splinter Forceps)	22
<b>Fine Curved Dissecting</b> (Dissecting & Ligature Forceps)	23
<b>Fergusson Acland</b> (Mouth Gags)	27
<b>Featherstone</b> (Mouth Gags)	27
<b>Flat</b> (Tongue Depressors)	28
<b>Forester</b> (Sponge Holding Forceps)	30
<b>Fraser - Adson</b> (Haemostats Forceps)	37
<b>Fraser-kelly</b> (Crile Haemostats Forceps)	37
<b>Fickling Oral</b> (Haemostats Forceps)	41
<b>Fistula Probe</b> (Probes)	49
<b>Farabeuf</b> (Hand Held Retractors)	58
<b>Faure</b> (Peritoneum)	89
<b>Female Catheters</b> (Urology)	93
<b>Frazier</b> (Suction Tubes)	95
<b>Formby</b> (Suction Tubes)	95
<b>Finger Saw</b> (Amputation Instruments)	96
<b>Farabeuf</b> (Bone Levers & Raspatories)	97
<b>Freer Elevator</b> (Bone Levers & Raspatories)	97
<b>Fergusson</b> (Bone Holding Forceps)	100
<b>Finocchietto - Infant</b> (Rib Spreaders)	110
<b>Finocchietto</b> (Rib Spreaders)	110
<b>Finocchietto-baby</b> (Rib Spreaders)	110

### G

<b>Gillies</b> (Toothed Dissecting Forceps)	19
<b>Grey Turner</b> (Haemostats Forceps)	34
<b>Gillies</b> (Needle Holders)	45
<b>Gwynne Evans Tonsil</b> (Dissectors)	51
<b>Gosset</b> (Hand Held Retractors)	61
<b>Goligher</b> (Hand Held Retractors)	62
<b>Geary Grant</b> (Cholecystectomy & Gall Stone)	65
<b>Gall Duct Scissors</b> (Cholecystectomy & Gall Stone)	66
<b>Grave</b> (Vaginal Speculum)	72
<b>Galabin</b> (Probes)	76
<b>Green - Armytage Haemostasis Forceps</b> (Dermatology)	88
<b>Gwilliam</b> (Hysterectomy Clamps)	89
<b>Gabriel Rectal Speculum</b> (Proctology)	91
<b>Gillies</b> (Suction Tubes)	94
<b>Gigli Saw With Handle</b> (Bone Rongeurs)	106
<b>Gregory-soft</b> (Atrauma Bulldog Clamps)	113
<b>Glover</b> (Atrauma Cardiovascular Forceps)	119,127
<b>Gregory</b> (Atrauma Cardiovascular Forceps)	115

### H

<b>Hegemann's Delicate</b> (Scissors)	10
<b>Heymann Turbinectomy</b> (Delicate Scissors)	11
<b>Hedgeman</b> (scissors)	13
<b>Hunter</b> (Splinter Forceps)	22
<b>Heywood-smith Tongue Forceps</b> (Tongue Depressors)	28
<b>Halstead Mosquito</b> (Haemostats Forceps)	32,33
<b>Heiss</b> (Haemostats Forceps)	40
<b>Heaney</b> (Needle Holders)	45
<b>Hegar</b> (Needle Holders)	46
<b>Halsey</b> (Needle Holders)	46

<b>Hawkin Ambler</b> (Uterine Dilators)	75
<b>Hegar</b> (Uterine Dilators)	75,76
<b>Hegar</b> (Uterine Dilators Complete Sets)	77
<b>Heywood Smith</b> (Ovum Forceps)	79
<b>Heany</b> (Hysterectomy Clamps)	89
<b>Hysterectomy Forceps</b> (Hysterectomy Clamps)	90
<b>Herrick</b> (Urology)	93
<b>House</b> (Suction Tubes)	95
<b>Handle</b> (Suction Tubes)	95
<b>Howarth</b> (Bone Levers & Raspatories)	97
<b>Heath</b> (Mallets)	100
<b>Hey Groves</b> (Bone Holding Forceps)	101
<b>Hartmann</b> (Bone Rongeurs)	103
<b>Heanley</b> (Bone Rongeurs)	104
<b>Handles</b> (Monopolar Handles, Blades, Needle, Turner Warwick Scissors)	132

### I

<b>Iris</b> (Delicate Scissors)	11
<b>Irwin</b> (Hand Held Retractors)	62
<b>I.u.d. Removing Hook</b> (Obstetrics Instruments)	86

### J

<b>Jefferson</b> (Delicate Dissecting Forceps)	18
<b>Jackson Burrows</b> (Toothed Dissecting Forceps)	21
<b>Jud-allis</b> (Tissue Forceps)	26
<b>Jameson</b> (Needle Holders)	45
<b>Jobson Horne</b> (Probes)	49
<b>Janson Shea</b> (Hand Held Retractors)	64
<b>Jefferson</b> (Hand Held Retractors)	64
<b>Joseph</b> (Bone Levers & Raspatories)	97
<b>Jacobson</b> (Bone Scoops)	99
<b>Jansen-middleton Septum Forceps</b> (Bone Rongeurs)	103
<b>Jansen</b> (Bone Rongeurs)	103
<b>Javid</b> (Atrauma Cardiovascular Forceps)	115
<b>Jeweler Forceps</b> (Bipolar Forceps)	129

### K

<b>Kilner</b> (Hcissors)	10
<b>Kelly-crile</b> (Haemostats Forceps)	35
<b>Kelly</b> (Haemostats Forceps)	35
<b>Kelly Halstead</b> (Haemostats Forceps)	35
<b>Kocher</b> (Haemostats Forceps)	35,36
<b>Kilner</b> (Needle Holders)	44
<b>Kings College Hospital Cocainising Wire</b> (Probes)	49
<b>Kocher Thyroid</b> (Dissectors)	50
<b>Kocher Thyroid</b> (Dissectors)	50
<b>King</b> (Dissectors)	50
<b>Kelly</b> (hand Held Retractors)	55
<b>Kocher</b> (Hand Held Retractors)	56,57,58
<b>Kocher Bone Hook</b> (Hand Held Retractors)	60
<b>Kirschner Retractor Set</b> (Hand Held Retractors)	61
<b>Kirschner Retractor Frame</b> (Hand Held Retractors)	61
<b>Kirschner Retractor Blades</b> (Hand Held Retractors)	61
<b>Kocher</b> (Intestinal Clamps)	68
<b>Kristelle</b> (Vaginal Speculum)	73
<b>Kogan Endocervical</b> (Vaginal Speculum)	74
<b>Kevorkian</b> (Cervical Biopsy Forceps)	82
<b>Kielland</b> (Obstetrics Instruments)	86
<b>Kelly Proctoscope</b> (Proctology)	91
<b>Kidney Clamp</b> (Urology)	92
<b>Kelsey Fry</b> (mallets)	100
<b>Killearn</b> (Bone Rongeurs)	105

## INDEX

### L

<b>Lloyd Davis Rectal</b> (Scissors)	09
<b>Lister Bandage</b> (Scissors)	14
<b>Lane</b> (Delicate Dissecting Forceps)	18
<b>Ligature Forceps</b> (Dissecting & Ligature Forceps)	23
<b>Lawrence</b> (Dissecting & Ligature Forceps)	24
<b>Long Curved</b> (Dissecting & Ligature Forceps)	24
<b>Lane</b> (Tissue Forceps)	25
<b>Lack Tongue Depressor</b> (Tongue Depressors)	28
<b>Lister - Sinus</b> (Dressing Forceps)	31
<b>Lloyd Davis</b> (Haemostats Forceps)	36
<b>Lawrance</b> (Needle Holders)	47
<b>Liebrich Lachrymal</b> (Probes)	49
<b>Logan Turner</b> (Probes)	49
<b>Littauer</b> (Suture Instruments)	51
<b>Littauer Spencer</b> (Suture Instruments)	51
<b>Liver Retractors</b> (Hand Held Retractors)	55
<b>Langenbeck</b> (Hand Held Retractors)	57
<b>Lahey</b> (Cholecystectomy & Gall Stone)	65
<b>Lower</b> (Cholecystectomy & Gall Stone)	65
<b>Langenbeck Bone Hook</b> (Hand Held Retractors)	60
<b>Lane</b> (Intestinal Clamps)	69
<b>Lang Stevenson</b> (Intestinal Clamps)	70
<b>Lane Twin Anastomosis</b> (Intestinal Clamps)	71
<b>Leech Wilkinson</b> (Cervical Biopsy Forceps)	81
<b>Lempert</b> (Bone Scoops)	99
<b>Lucae</b> (Mallets)	100
<b>Lane</b> (Bone Holding Forceps)	101
<b>Lowman</b> (Bone Holding Forceps)	101
<b>Lewin</b> (Bone Holding Forceps)	102
<b>Luer</b> (Bone Rongeurs)	103
<b>Leksell</b> (Bone Rongeurs)	104
<b>Luer-jansen</b> (Bone Rongeurs)	105
<b>Liston Tudor Edwards</b> (Bone Cutting Forceps)	108
<b>Lovelace</b> (Tissue & Organ)	112
<b>Leland Jones</b> (Atrauma Cardiovascular Forceps)	121
<b>Lambert - Kay</b> (Atrauma Cardiovascular Forceps)	125

### M

<b>Miller</b> (Laryngoscope Set)	02
<b>Magill</b> (Catheter Forceps)	03
<b>Mcintosh</b> (Laryngoscope Set)	03
<b>Mayo</b> (Scissors)	06
<b>Mayo Harrington</b> (Scissors)	07
<b>Mayo Stille</b> (Scissors)	07
<b>Metzenbaum</b> (Scissors)	08
<b>Mcindoe Scissors</b> (Scissors)	14
<b>Maingot Intestinal</b> (Serrated Dissecting Forceps)	16
<b>Macindoe</b> (Delicate Dissecting Forceps)	17
<b>Micindoe</b> (Toothed Dissecting Forceps)	19
<b>Mustarde</b> (Toothed Dissecting Forceps)	21
<b>Micro Soft Touch Ring Tip</b> (Splinter Forceps)	22
<b>Micro Adson</b> (Dissecting & Ligature Forceps)	23
<b>Mixer</b> (Dissecting & Ligature Forceps)	24
<b>Mayo</b> (Towel Clamps)	29
<b>Moynihan</b> (Towel Clamps)	29
<b>Mayo</b> (Haemostats Forceps)	36
<b>Moynihan</b> (Haemostats Forceps)	40
<b>Mixer</b> (Haemostats Forceps)	40
<b>Mayo Dunhill</b> (Needle Holders)	43
<b>Mayo</b> (Needle Holders)	43,44
<b>Morris</b> (Hand Held Retractors)	54
<b>Moynihan</b> (Hand Held Retractors)	56
<b>Mayo</b> (Needle Holders)	46,47
<b>Mayo Baumgartner</b> (Needle Holders)	46
<b>Mayo Masson</b> (Needle Holders)	46
<b>Mathieu</b> (Needle Holders)	46

<b>Mathieu</b> (Needle Holders)	47
<b>Mcphails</b> (Needle Holders)	47
<b>Macdonald</b> (Dissectors)	50
<b>Middeldorpf</b> (Hand Held Retractors)	56
<b>Mixer</b> (Cholecystectomy & Gall Stone)	65
<b>Mills</b> (Cholecystectomy & Gall Stone)	66
<b>Moynihan</b> (Cholecystectomy & Gall Stone)	66
<b>Mouat Gall Bladder Lifting Forceps</b> (Cholecystectomy & Gall Stone)	66
<b>Mcgee Lateral Viginal Retractor</b> (Vaginal Speculum)	72
<b>Mathieu</b> (Vaginal Speculum)	74
<b>Modified Wertheim</b> (Vaginal Speculum)	74
<b>Martin</b> (Probes)	76
<b>McIntock</b> (Ovum Forceps)	79
<b>Mikulicz</b> (Peritoneum)	89
<b>Maingot</b> (Hysterectomy Clamps)	90
<b>Mcevedy Rectal Speculum</b> (Proctology)	91
<b>Millin</b> (Urology)	92
<b>Macdonald</b> (Bone Levers & Raspatories)	97
<b>Martini</b> (Bone Scoops)	99
<b>Macewen</b> (Bone Scoops)	99
<b>Mead</b> (Bone Rongeurs)	103
<b>Martin</b> (Atrauma Cardiovascular Forceps)	116
<b>Measuring</b> (Vascular Measuring Device)	117
<b>Morris De Bakey</b> (Atrauma Cardiovascular Forceps)	125
<b>Mcpherson</b> (Bipolar Forceps)	129
<b>Monopolar Cables</b> ( Monopolar Cables)	131
<b>Mcindoe</b> ( Monopolar Cables)	131

### N

<b>Nelson Lung Adhesion</b> (Toothed Dissecting Forceps)	21
<b>Negus Tonsil</b> (Tonsil Artery Forceps)	42
<b>Naunton Morga</b> (Needle Holders)	44
<b>Norfolk And Norwich</b> (Hand Held Retractors)	63
<b>Noto</b> (Ovum Forceps)	79
<b>Naegele</b> (Obstetrics Instruments)	86
<b>Naunton Morgan Sims Rectal Speculum</b> (Proctology)	91
<b>Northfield</b> (Bone Rongeurs)	104,105
<b>Needle</b>	132
(Monopolar Handles,Blades,Needle,Turner Warwick Scissors)	

### O

<b>Otoscope Set</b>	01
<b>Officer</b> (Toothed Dissecting Forceps)	21
<b>O'shaughnessy</b> (Haemostats Forceps)	41
<b>Olsen Hegar</b> (Needle Holders)	45
<b>Olivecrona</b> (Bone Rongeurs)	106
<b>Ochsner</b> (Cardiovascular Forceps)	114

### P

<b>Potts</b> (Scissors)	13
<b>Pennybacker</b> (Delicate Dissecting Forceps)	18
<b>Probe With Eye</b> (Probes)	48
<b>Payr</b> (Dissectors)	51
<b>Potts-de Martel</b> (Cholecystectomy & Gall Stone)	66
<b>Parker Kerr</b> (Intestinal Clamps)	70
<b>Payr</b> (Intestinal Clamps)	70
<b>Pederson</b> (Vaginal Speculum)	72
<b>Peritoneum</b> (Peritoneum)	89
<b>Phaneuf</b> (Hysterectomy Clamps)	90
<b>Pratt Rectal Speculum</b> (Proctology)	91
<b>Poole</b> (Suction Tubes)	94
<b>Percy Amputation Flap Retractor</b> (Amputation Instruments)	96

## INDEX

<b>Pennybacker</b> (Bone Levers & Raspatories)	98
<b>Pennybacker</b> (Bone Rongeurs)	104
<b>Plaster Shears</b> (Plaster Cast Removal Instruments)	109
<b>Price-thomas</b> (Bronchus)	112
<b>Potts</b> (Atrauma Cardiovascular Forceps)	119,120
<b>Patient Care Items</b> (Patient Care Items)	137
<b>Patient Treatment Items</b> (Patient Treatment Items)	138

### R

<b>Reynolds</b> (Scissors)	14
<b>Ramsey</b> (Serrated Dissecting Forceps)	16
<b>Ramsey</b> (Toothed Dissecting Forceps)	20
<b>Russian</b> (Toothed Dissecting Forceps)	21
<b>Rutherford Morison</b> (Tissue Forceps)	25
<b>Robin</b> (Towel Clamps)	29
<b>Ramley</b> (Sponge Holding Forceps)	30
<b>Rochester - Oschner</b> (Haemostats Forceps)	36,37
<b>Rochster Pean</b> (Haemostats Forceps)	39
<b>Roberts</b> (Haemostats Forceps)	40
<b>Richardson</b> (Hand Held Retractors)	54
<b>Retractor</b> (Hand Held Retractors)	60
<b>Ricard</b> (Hand Held Retractors)	61
<b>Rntne Hospital</b> (Hand Held Retractors)	63
<b>Recamier</b> (Uterine Cannulae)	85
<b>Randall</b> (Urology)	92
<b>Ruskin</b> (Bone Rongeurs) 1	103
<b>Rudor Edwards Costotome</b> (Bone Rongeurs)	106
<b>Ruskin - Liston</b> (Bone Cutting Forceps)	108
<b>Riches Forceps</b> (Monopolar Cables)	131

### S

<b>Surgical Handles</b> (Standard)	04,05
<b>Strabismus</b> (Delicate Scissors)	11
<b>Stevens Tenotomy</b> (Delicate Scissors)	12
<b>Schuknecht Wire Cutting</b> (Oral Scissors)	12
<b>Schumacher Umbilical</b> (Scissors)	14
<b>St Marks</b> (Serrated Dissecting Forceps)	16
<b>St Marks</b> (Toothed Dissecting Forceps)	21
<b>S.shaped Delicate</b> (Dissecting & Ligature Forceps)	23
<b>Stiles Allis-Thoms</b> (Tissue Forceps)	25
<b>Spencer Wells</b> (Haemostats Forceps)	38
<b>Schmidt Tonsil</b> (Tonsil Artery Forceps)	42
<b>Sinus</b> (Probes)	48
<b>Simon</b> (Hand Held Retractors)	59
<b>Seton Pringle Bainbridge</b> (Intestinal Clamps)	69
<b>Schoemaker</b> (Intestinal Clamps)	70
<b>Sims</b> (Vaginal Speculum)	73
<b>Sims</b> (Probes)	76
<b>Schroeder</b> (Tenaculum Forceps)	78
<b>Schubert</b> (Cervical Biopsy Forceps)	81
<b>Schumarcher</b> (Cervical Biopsy Forceps)	82
<b>Simon</b> (Uterine Scoops And Curettes)	83
<b>Sims</b> (Uterine Scoops And Curettes)	83
<b>Sims</b> (Uterine Curettes)	84
<b>Sims</b> (Uterine Cannulae)	85
<b>Simpson</b> (Obstetrics Instruments)	86
<b>Simpson-Braun</b> (Obstetrics Instruments)	86
<b>Saenger Ovum Forceps</b> (Gynecology Instruments)	88
<b>Sims Rectal Speculum</b> (Proctology)	91
<b>Suction Tubes</b> (Suction Tubes)	95
<b>Spare Disks</b> (Mallets)	100
<b>Sequestum</b> (Bone Holding Forceps)	100
<b>Semb</b> (Bone Holding Forceps)	102
<b>Synovectomy Rongeur</b> (Bone Rongeurs)	104
<b>Sargent Van Havre</b> (Bone Rongeurs)	106

<b>Stille-ruskin</b> (Bone Rongeurs)	106
<b>Stille Liston</b> (Bone Cutting Forceps)	108
<b>Semb</b> (Ligature Carriers)	112
<b>Scalple Handle</b> (Monopolar Handles,Blades,Needle,Turner Warwick Scissors)	132

### T

<b>Treves</b> (Delicate Dissecting Forceps)	18
<b>Troeltsch Wilde</b> (Splinter Forceps)	22
<b>Tudichum</b> (Splinter Forceps)	22
<b>Tubing Clamp</b> (Haemostats Forceps)	41
<b>Travers</b> (Hand Held Retractors)	62
<b>Tischler-morgan</b> (Cervical Biopsy Forceps)	82
<b>Tinckler Simpson Smith</b> (Suction Tubes)	94
<b>Trotter</b> (Bone Rongeurs)	104
<b>Treatment Room Items</b> (Treatment Room Items)	139,141

### U

<b>Uterine</b> (Scissors)	09
<b>Umbilical Dilator</b> (Gynecology Instruments)	88

### V

<b>Volkman</b> (Bone Levers & Raspatories)	98
<b>Volkman</b> (Bone Scoops)	99
<b>Verbrugge</b> (Bone Holding Forceps)	102

### W

<b>Woods Tonsil</b> (Oral Scissors)	12
<b>Wheeler Tonsil</b> (Oral Scissors)	12
<b>Wilson Tonsil</b> (Oral Scissors)	12
<b>Waugh</b> (Delicate Dissecting Forceps)	17,18
<b>Wilson Tonsil</b> (Tonsil Artery Forceps)	42
<b>Wangensteen</b> (Needle Holders)	44
<b>Wright</b> (Needle Holders)	45
<b>Ward</b> (Needle Holders)	45
<b>Webster</b> (Needle Holders)	47
<b>Watson Cheyne</b> (Dissectors)	50
<b>Walton</b> (Hand Held Retractors)	58
<b>Weislander</b> (Hand Held Retractors)	63
<b>Weislander</b> (Hand Held Retractors)	63,64
<b>Wilson</b> (Tenaculum Forceps)	78
<b>Wittner</b> (Cervical Biopsy Forceps)	82
<b>Wrigley</b> (Obstetrics Instruments)	86
<b>Winter Ovum Forceps</b> (Gynecology Instruments)	88
<b>Williger</b> (Bone Levers & Raspatories)	97
<b>Wilms</b> (Bone Rongeurs)	104
<b>Ward</b> (Bone Cutting Forceps)	108
<b>Wilson Hey Forceps</b> (Monopolar Cables)	131

### Y

<b>Yankauer</b> (Suction Tubes)	94
---------------------------------	----

### Z

<b>Zaufal-Jansen</b> (Bone Rongeurs)	105
--------------------------------------	-----

*High Quality  
Instruments*

Diagnostic  
Laryngoscope  
Scissors  
Dissecting  
Hamostats Forceps  
Needle Holders  
Retractors  
Cordio Vascular  
Electro Surgical  
Hollow Ware

 **A I L S A I F**  
Traders  
Manufacturer & Exporters of Surgical Instruments

**SURGICAL**  
*INSTRUMENTS*

