

# DENTAL INSTRUMENTS

*High Quality  
Instruments*

Extraction Sets  
Extracting Forceps  
Root Elevators  
Bone Rongeurs  
Orthodontic Pliers  
Scalers  
Impression Trays



# ALSAIF Traders

**Manufacturer & Exporters of Surgical Instruments**

📍 Dulchikey, Ugoki Wazirabad Road, Sialkot-Pakistan

Email: [alsaifraders7@gmail.com](mailto:alsaifraders7@gmail.com)

E-mail: [info@alsaifraders.com](mailto:info@alsaifraders.com)

Web: [www.alsaifraders.com](http://www.alsaifraders.com)

📞 +92-300-6104824

📞 +92-52-3570286

## PROFILE



*We present this CATALOGUE with a hope that it would be an excellent guide to all over promoters and Dental professionals the world over.*

*We endeavor to present in this CATALOGUE a modern range of instruments to the trade and medical professionals in order to achieve the highest result.*

*We are the located in the center of the city which is known the world over for this profession having at our disposal expert crafted whose skilled technique and traditional approach towards modern surgery makes all the possibilities to acclaim us quality instruments producers.*

*We are grateful for the loyal support given to us by our promoters who have been selling our Stainless Steel Dental Instruments in their market with pride and honor.*

*We pledge to serve more in the years ahead to our quality minded promoters with much more higher standard and correct design of the instruments.*

*We also welcome our enquiries for the instruments not listed in This CATALOGUE both in Dental instruments.*

*It is our earnest desire to maintain our present price but due to the present universal economic condition which are beyond our control, all prices are subjected to change without any notice.*

## Root Elevators Set, Extraction Set ●●●



Set - 01

### KIT ROOT ELEVATORS (Complete Set of 6 Pcs.)

- |    |                       |         |
|----|-----------------------|---------|
| 01 | ROOT ELEVATORS APICAL | Fig.301 |
| 02 | ROOT ELEVATORS APICAL | Fig.302 |
| 03 | ROOT ELEVATORS APICAL | Fig.303 |
| 04 | ROOT ELEVATORS SELDIN | Fig.34S |
| 05 | ROOT ELEVATORS CRYER  | Fig.44  |
| 06 | ROOT ELEVATORS CRYER  | Fig.45  |



Set - 02

### EXTRACTION AND ORAL SURGERY (Complete Set of 9Pcs.)

- |    |                          |          |
|----|--------------------------|----------|
| 01 | EXTRACTING FORCEPS       | Fig. 67A |
| 02 | EXTRACTING FORCEPS       | Fig. 51A |
| 03 | EXTRACTING FORCEPS       | Fig. 33  |
| 04 | EXTRACTING FORCEPS       | Fig. 79  |
| 05 | ROOT ELEVATORS FLOHR     | Fig. 20  |
| 06 | ROOT ELEVATORS FLOHR     | Fig. 238 |
| 07 | ROOT ELEVATORS FLOHR     | Fig. 239 |
| 08 | MAYO HEGAR NEEDLE HOLDER | 16 cm    |
| 09 | MATHIEU NEEDLE HOLDER    | 14 cm    |



● ● ● Extraction Set



Set - 03

**INSTRUMENTS SET FOR EXTRACTION**  
(Complete Set of 9 Pcs.)

- |    |                       |          |
|----|-----------------------|----------|
| 01 | EXTRACTING FORCEPS    | Fig. 67A |
| 02 | EXTRACTING FORCEPS    | Fig. 51A |
| 03 | EXTRACTING FORCEPS    | Fig. 33  |
| 04 | EXTRACTING FORCEPS    | Fig. 79  |
| 05 | ROOT ELEVATORS FLOHR  | Fig. 20  |
| 06 | ROOT ELEVATORS FLOHR  | Fig. 238 |
| 07 | ROOT ELEVATORS FLOHR  | Fig. 239 |
| 08 | ROOT ELEVATORS WINTER | Fig. 320 |
| 09 | ROOT ELEVATORS WINTER | Fig. 321 |



Set - 04

**INSTRUMENTS SET FOR EXTRACTION**  
(Complete Set of 8 Pcs.)

- |    |                    |          |
|----|--------------------|----------|
| 01 | EXTRACTING FORCEPS | Fig. 1   |
| 02 | EXTRACTING FORCEPS | Fig. 17  |
| 03 | EXTRACTING FORCEPS | Fig. 18  |
| 04 | EXTRACTING FORCEPS | Fig. 79  |
| 05 | EXTRACTING FORCEPS | Fig. 67A |
| 06 | EXTRACTING FORCEPS | Fig. 51A |
| 07 | EXTRACTING FORCEPS | Fig. 13  |
| 08 | EXTRACTING FORCEPS | Fig. 22  |





Set - 05

**INSTRUMENTS SET FOR EXTRACTION**  
(Complete Set of 8 Pcs.)

- |    |                    |          |
|----|--------------------|----------|
| 01 | EXTRACTING FORCEPS | Fig. 1   |
| 02 | EXTRACTING FORCEPS | Fig. 17  |
| 03 | EXTRACTING FORCEPS | Fig. 18  |
| 04 | EXTRACTING FORCEPS | Fig. 79  |
| 05 | EXTRACTING FORCEPS | Fig. 67A |
| 06 | EXTRACTING FORCEPS | Fig. 51A |
| 07 | EXTRACTING FORCEPS | Fig. 13  |
| 08 | EXTRACTING FORCEPS | Fig. 22  |



Set - 06

**EXTRACTION FORCEPS FOR CHILDREN**  
(Complete Set of 10 Pcs.)

- |    |                         |          |
|----|-------------------------|----------|
| 01 | EXTRACTING FORCEPS FINO | Fig. 37  |
| 02 | EXTRACTING FORCEPS FINO | Fig. 39  |
| 03 | EXTRACTING FORCEPS FINO | Fig. 39L |
| 04 | EXTRACTING FORCEPS FINO | Fig. 39R |
| 05 | EXTRACTING FORCEPS FINO | Fig. 51S |
| 06 | EXTRACTING FORCEPS FINO | Fig. 13S |
| 07 | EXTRACTING FORCEPS FINO | Fig. 30S |
| 08 | EXTRACTING FORCEPS FINO | Fig. 33S |
| 09 | EXTRACTING FORCEPS FINO | Fig. 22S |
| 10 | EXTRACTING FORCEPS FINO | Fig. 38  |



● ● ● Extraction Set



Set - 07

**INSTRUMENTS SET FOR EXTRACTING FORCEPS**  
(Complete Set of 10 Pcs.)

- |    |                    |          |
|----|--------------------|----------|
| 01 | EXTRACTING FORCEPS | Fig. 2   |
| 02 | EXTRACTING FORCEPS | Fig. 7   |
| 03 | EXTRACTING FORCEPS | Fig. 51A |
| 04 | EXTRACTING FORCEPS | Fig. 17  |
| 05 | EXTRACTING FORCEPS | Fig. 18  |
| 06 | EXTRACTING FORCEPS | Fig. 67A |
| 07 | EXTRACTING FORCEPS | Fig. 13  |
| 08 | EXTRACTING FORCEPS | Fig. 33  |
| 09 | EXTRACTING FORCEPS | Fig. 22  |
| 10 | EXTRACTING FORCEPS | Fig. 79  |



Set - 08

**EXTRACTING FORCEPS SET FOR CHILDREN KLEIN PATTERN**  
(Complete Set of 7 Pcs.)

- |    |                             |          |
|----|-----------------------------|----------|
| 01 | EXTRACTING FORCEPS CHILDREN | Fig. 5   |
| 02 | EXTRACTING FORCEPS CHILDREN | Fig. 6   |
| 03 | EXTRACTING FORCEPS CHILDREN | Fig. 7   |
| 04 | EXTRACTING FORCEPS CHILDREN | Fig. 137 |
| 05 | EXTRACTING FORCEPS CHILDREN | Fig. 139 |
| 06 | EXTRACTING FORCEPS CHILDREN | Fig. 3   |
| 07 | EXTRACTING FORCEPS CHILDREN | Fig. 51S |



## EXTRACTING FORCEPS ENGLISH PATTERN ●●●

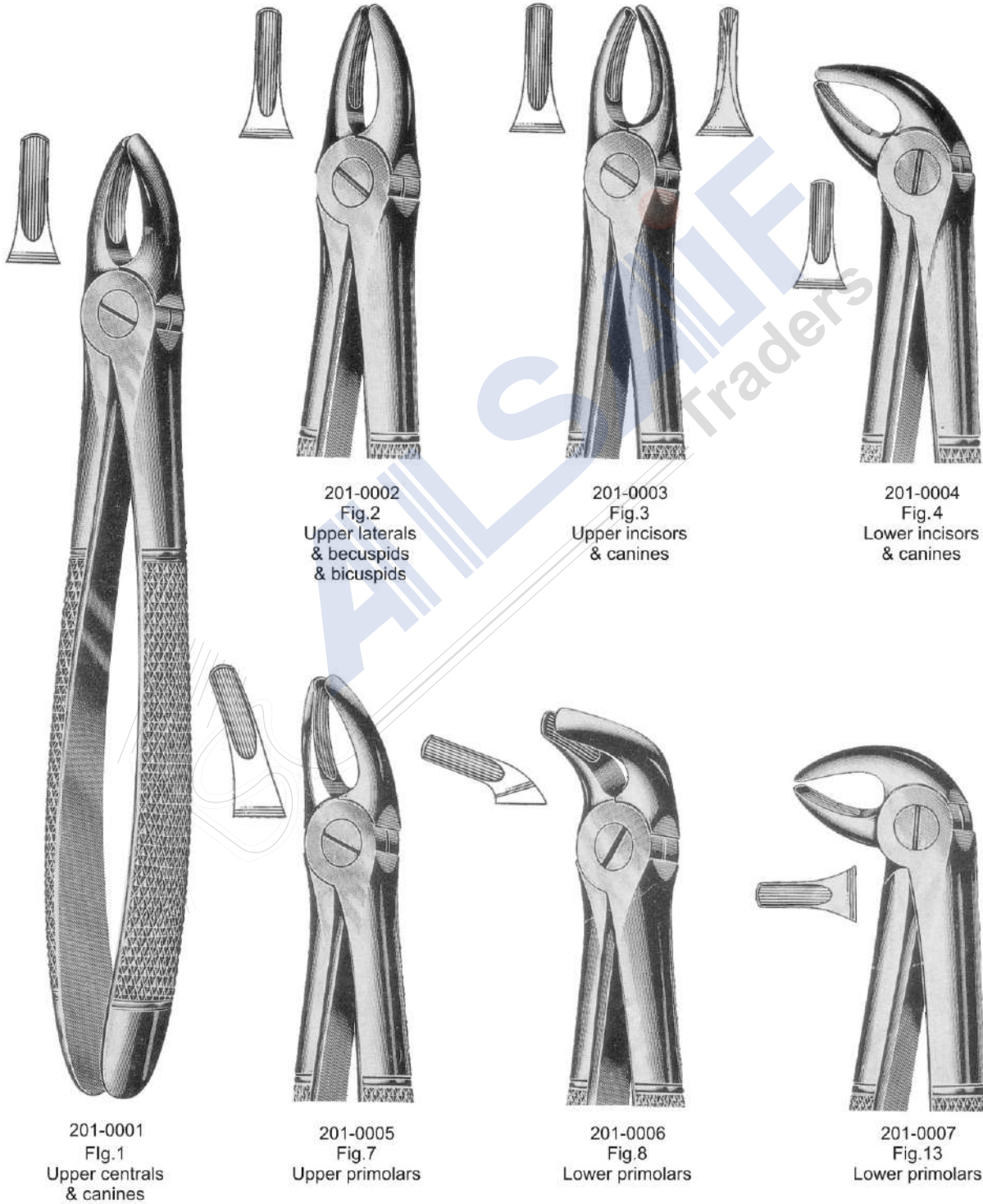

●●● **EXTRACTING FORCEPS** ENGLISH PATTERN

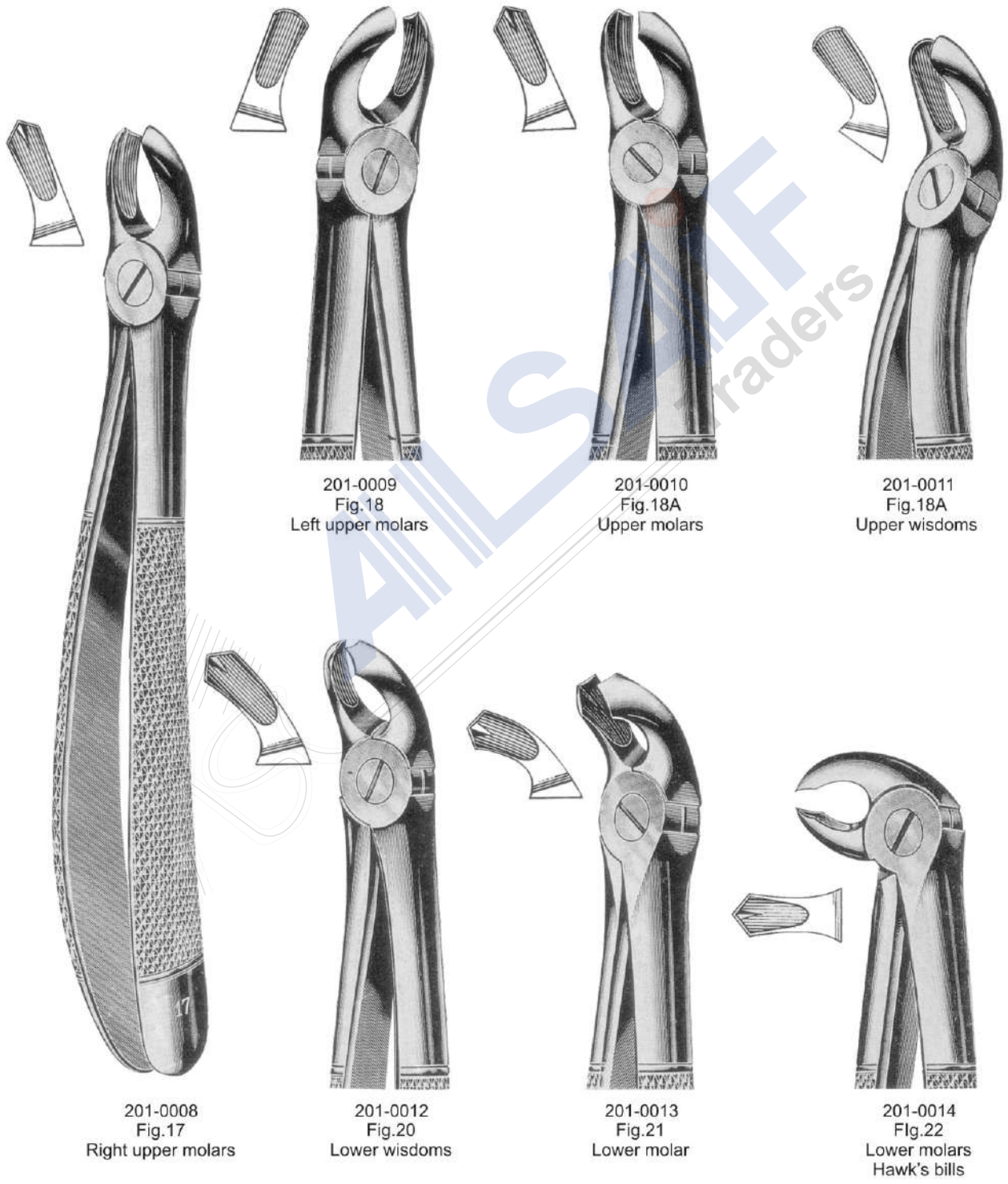

201-0009  
Fig.18  
Left upper molars

201-0010  
Fig.18A  
Upper molars

201-0011  
Fig.18A  
Upper wisdoms

201-0008  
Fig.17  
Right upper molars

201-0012  
Fig.20  
Lower wisdoms

201-0013  
Fig.21  
Lower molar

201-0014  
Fig.22  
Lower molars  
Hawk's bills



## EXTRACTING FORCEPS ENGLISH PATTERN ● ● ●



201-0015  
 Fig.23  
 Right lower molars



201-0016  
 Fig.24  
 Left lower molars

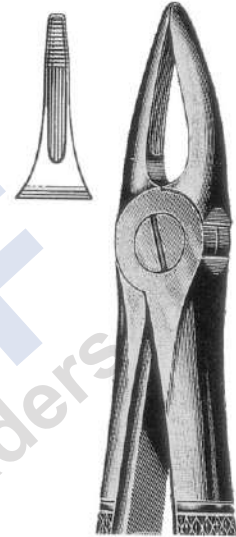

201-0017  
 Fig.29  
 Upper root & incisors

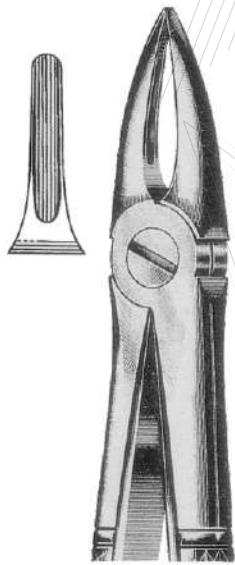

201-0018  
 Fig.29N  
 Roots of upper incisors

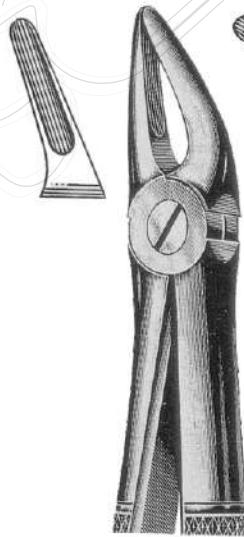

201-0019  
 Fig.30  
 Upper roots & incisors

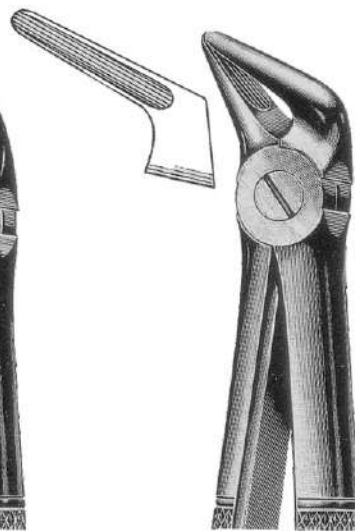

201-0020  
 Fig.31  
 Lower roots

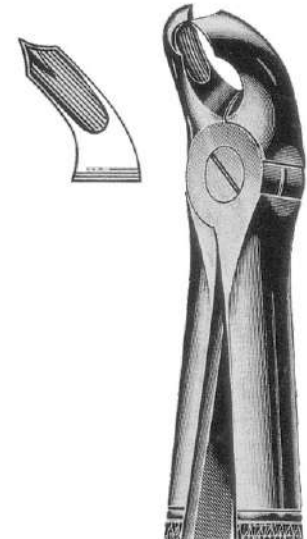

201-0021  
 Fig.32  
 Lower molars

●●● **EXTRACTING FORCEPS** ENGLISH PATTERN

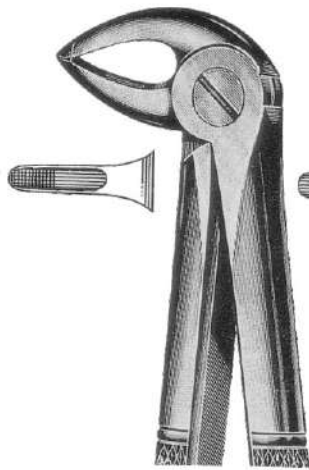

201-0022  
Fig.33  
Lower roots



201-0023  
Fig.33A  
Lower roots

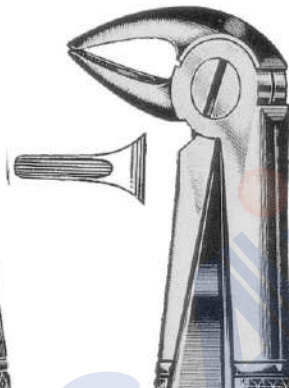

201-0024  
Fig.33C  
Lower roots

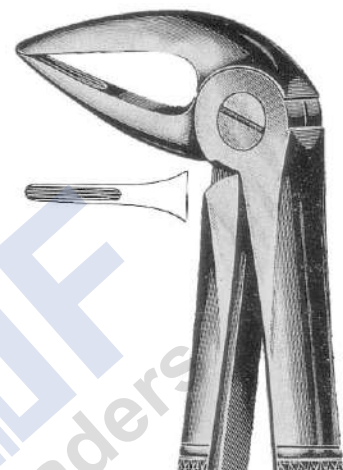

201-0025  
Fig.33M  
Lower roots with long beak

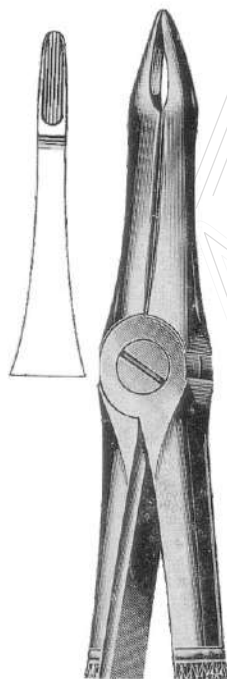

201-0026  
Fig.41  
Upper roots

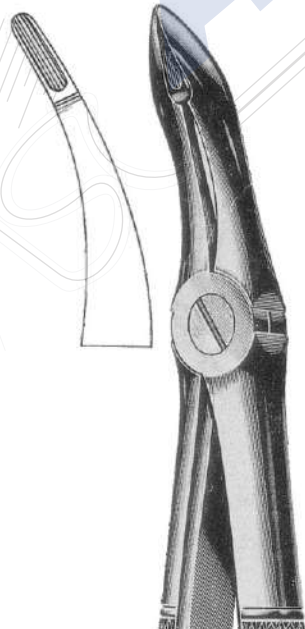

201-0027  
Fig.44  
Upper roots

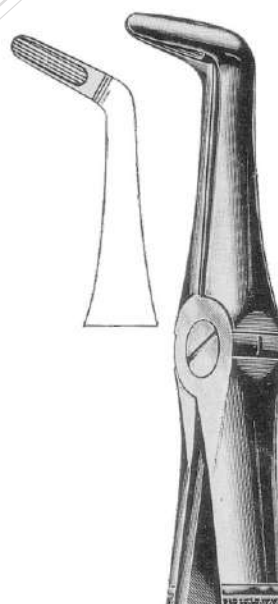

201-0028  
Fig.45  
Lower roots

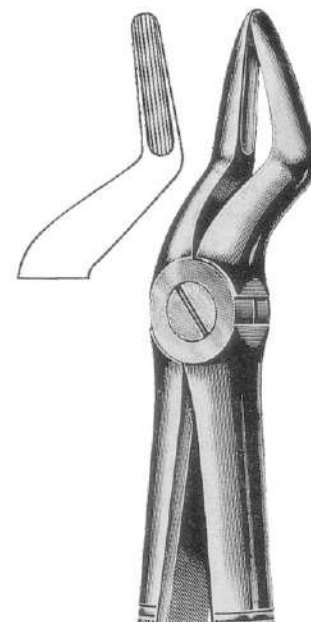

201-0029  
Fig.51  
Upper roots

## EXTRACTING FORCEPS ENGLISH PATTERN ●●●

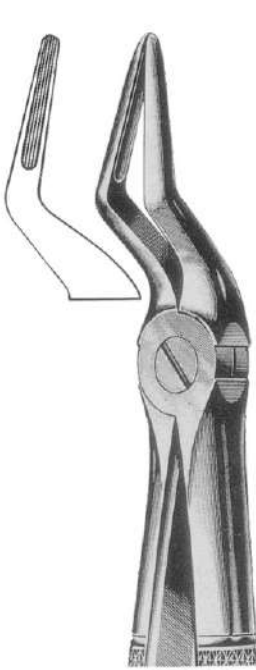

201-0030  
Fig.51A  
Upper roots narrow beak

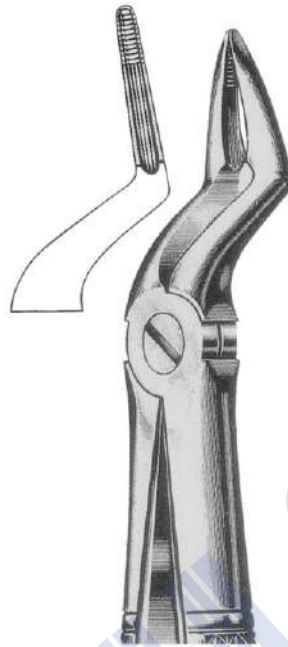

201-0031  
Fig.51C  
Upper roots

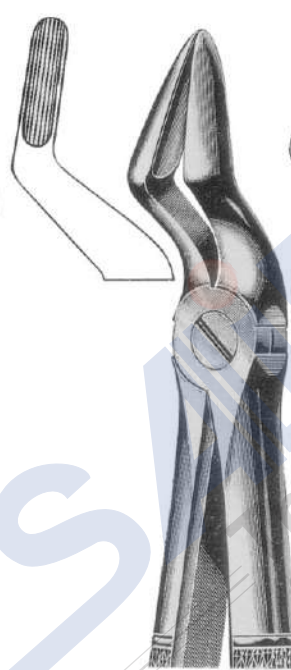

201-0032  
Fig.52  
Upper roots & canines  
with wider beak

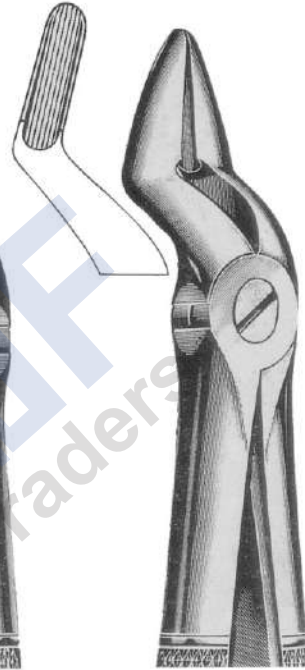

201-0033  
Fig.52A  
Upper teeth & resection

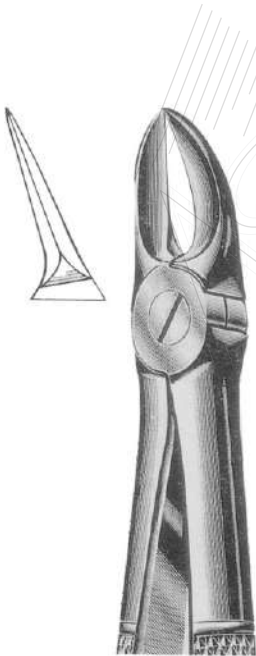

201-0034  
Fig.55  
Separating upper molars roots

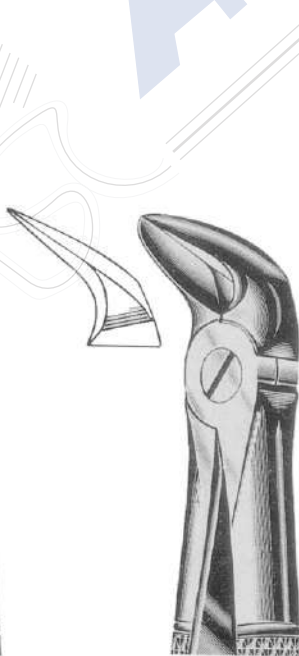

201-0035  
Fig.56  
Separating lower molars roots



201-0036  
Fig.67  
Upper wisdoms

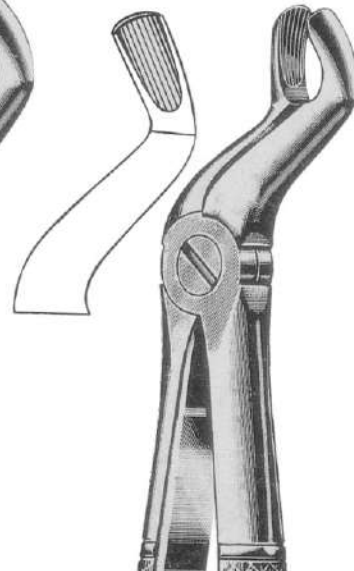

201-0037  
Fig.67A  
Upper wisdoms

●●● **EXTRACTING FORCEPS** ENGLISH PATTERN

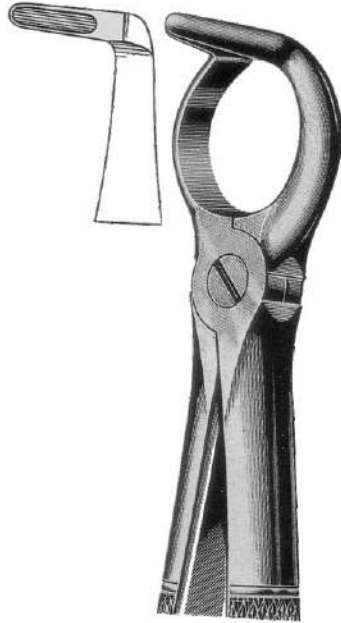

201-0038  
Fig.68  
Lower roots

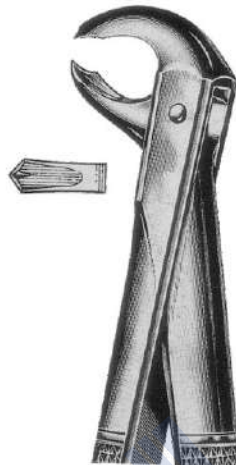

201-0039  
Fig.73  
Lower molars (hawk's bill)

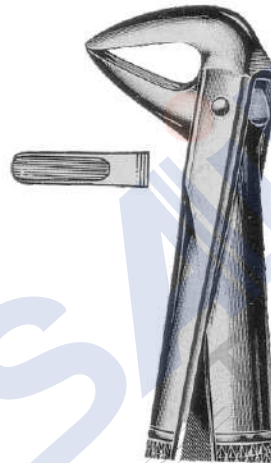

201-0040  
Fig.74  
Lower incisors & roots

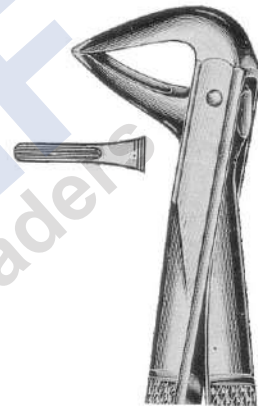

201-0041  
Fig.74M  
Lower incisors & roots



201-0042  
Fig.74N  
Lower incisors & roots

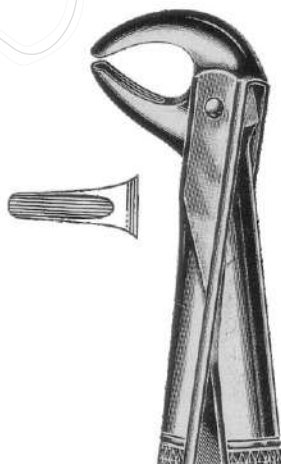

201-0043  
Fig.75  
Lower premolars & canines

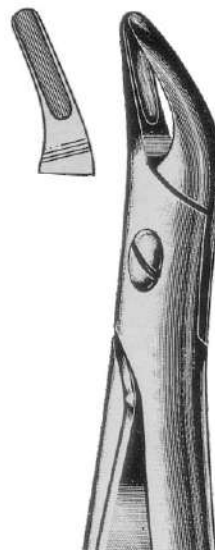

201-0044  
Fig.76  
Upper roots

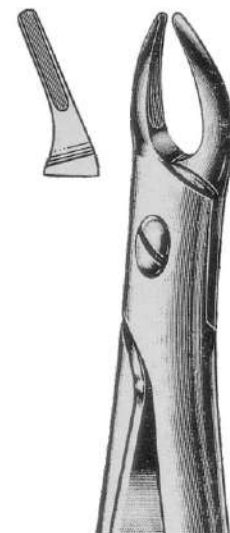

201-0045  
Fig.76N  
Upper roots  
Narrow break

## EXTRACTING FORCEPS ENGLISH PATTERN ●●●

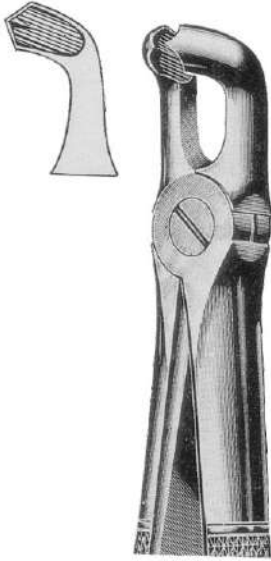

201-0046  
Fig.79  
Lower wisdoms

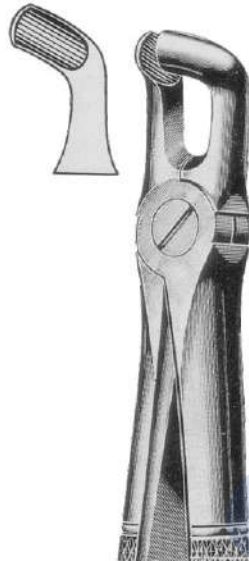

201-0047  
Fig.79A  
Lower wisdoms



201-0048  
Fig.86A  
Lower molars



201-0049  
Fig. 86B  
Lower molars



201-0050  
Fig.86C  
Lower molars

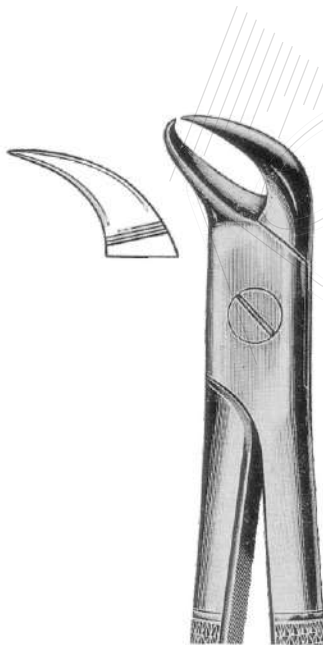

201-0051  
Fig.87  
Cowhorn beak

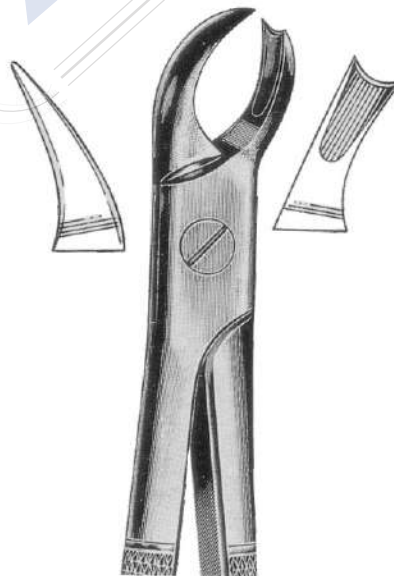

201-0052  
Fig.89  
Right upper molars



201-0053  
Fig.9  
Left upper molars

## EXTRACTING FORCEPS ENGLISH PATTERN

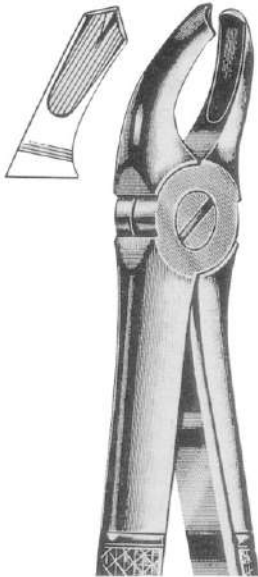

201-0054  
Fig.94  
Right upper molars

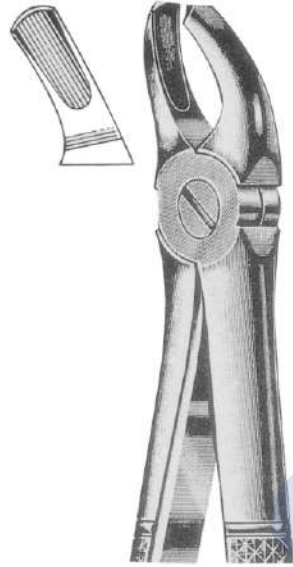

201-0055  
Fig.95  
Left upper molars

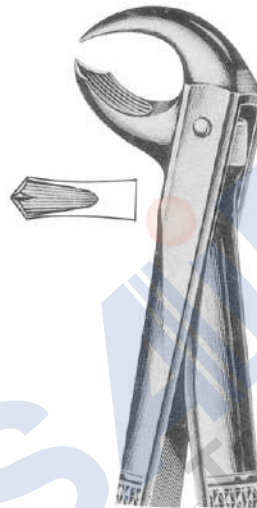

201-0056  
Fig.99  
Lower molars  
(broken-down)



201-0057  
Fig.99 1/4  
Lower molars  
(broken-down)

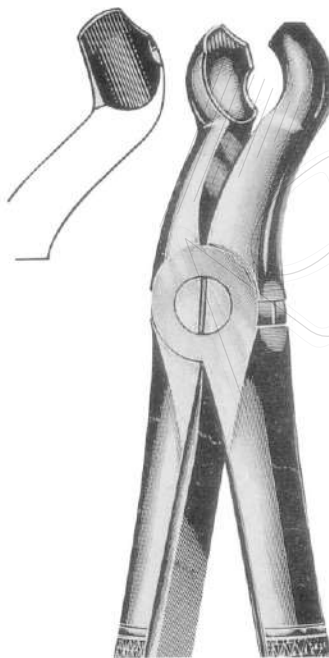

201-0058  
Fig.121  
Upper wisdoms

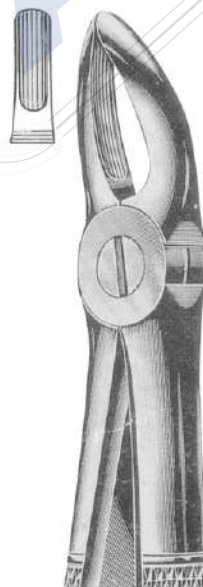

201-0059  
Fig.136  
Upper centrals  
& roots

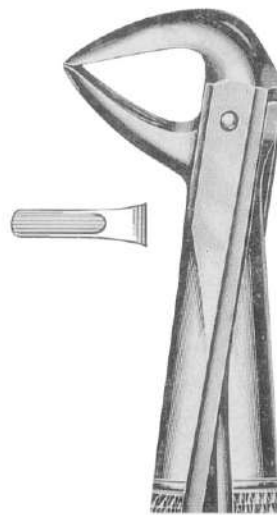

201-0060  
Fig.137  
Lower centrals  
& roots

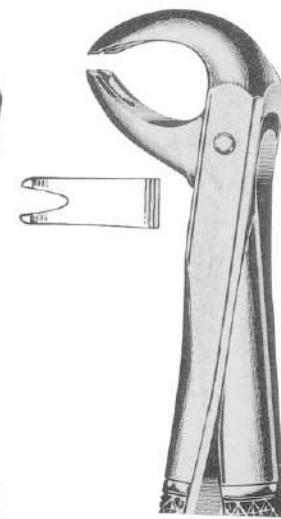

201-0061  
Fig.167  
Universal pincer  
for lower teeth  
molars & premolars

## EXTRACTING FORCEPS ENGLISH PATTERN ●●●



## ●●● EXTRACTING FORCEPS ENGLISH PATTERN

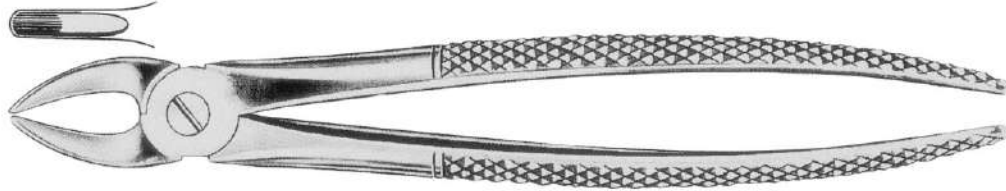

201-0070

Fig.37

Children's upper incisors & canines

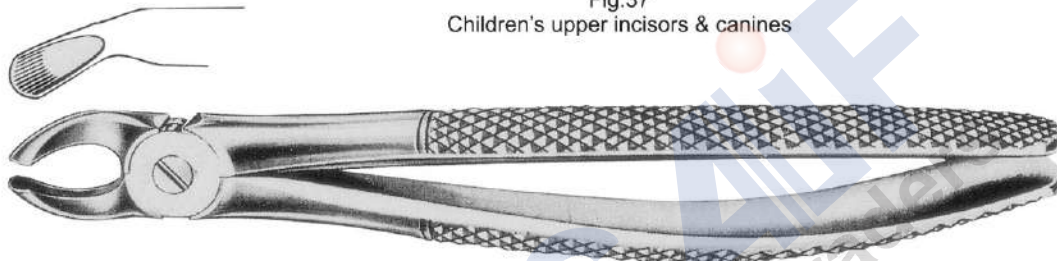

201-0071

Fig.39

Children's upper molars & universal

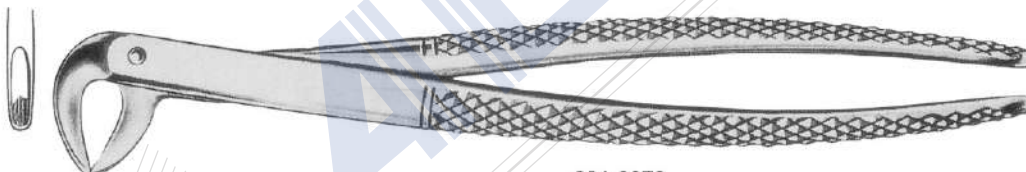

201-0072

Fig.123

Children's lower teeth universal

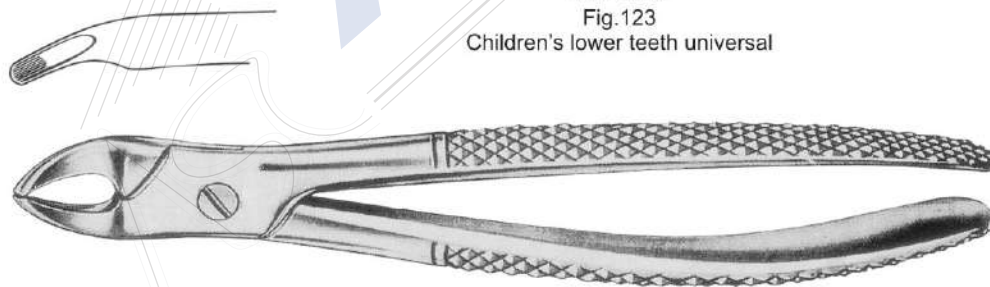

201-0073

Fig.138

Children's upper universal & roots

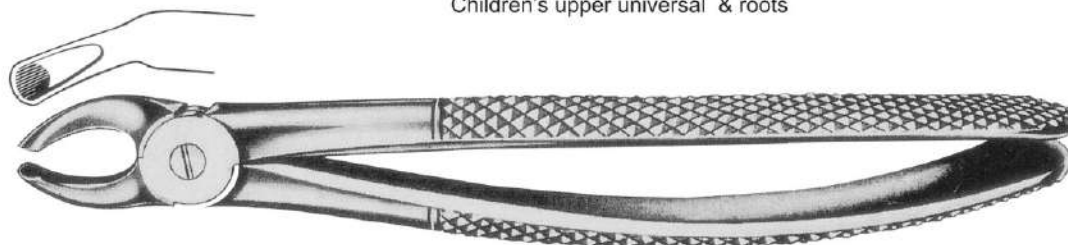

201-0074

Fig.157

Children's upper molars universal



## EXTRACTING FORCEPS CHILDREN'S PATTERN ● ● ●

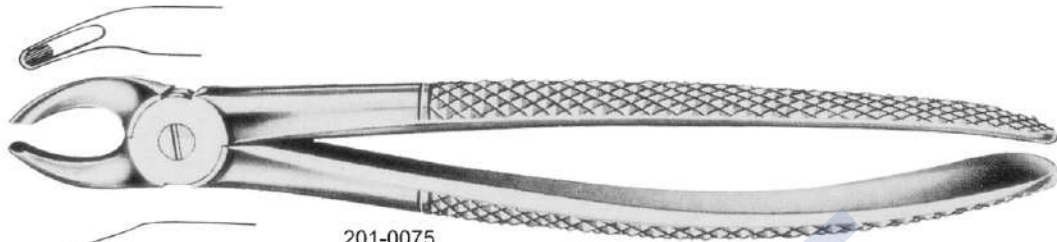

201-0075

Fig.158

Children's upper teeth molars universal

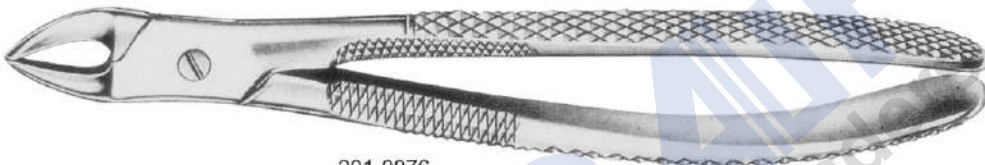

201-0076

Fig.159

Children's lower molars universal

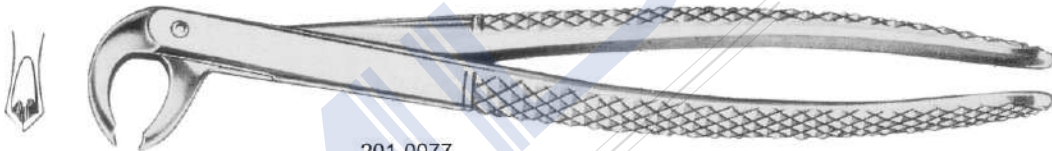

201-0077

Fig.160

Children's upper lower universal (hawk's bill)

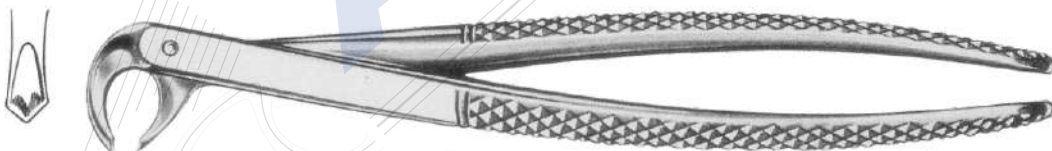

201-0078

Fig.161

Children's lower & roots

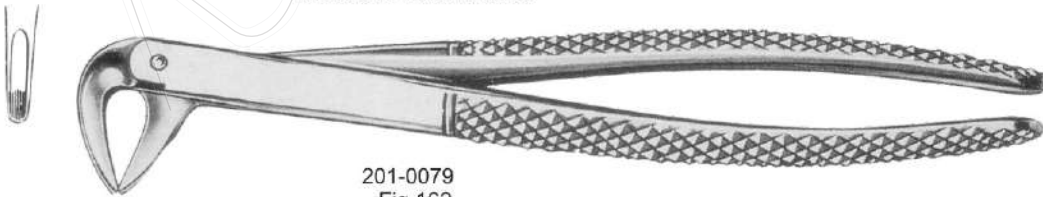

201-0079

Fig.162

Children's upper centrals



201-0080

Fig.163

Children's upper centrals

●●● **EXTRACTING FORCEPS** FOR CHILDREN'S WITH SPRING

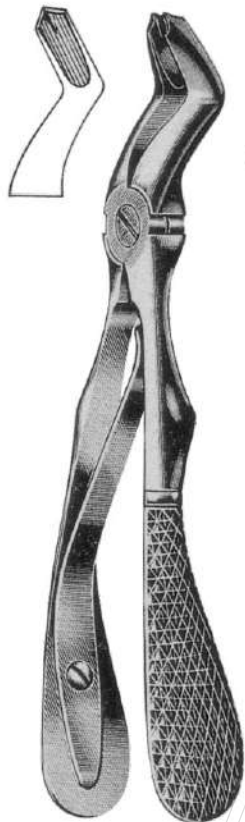

201-0081  
Fig. 3  
Upper molars

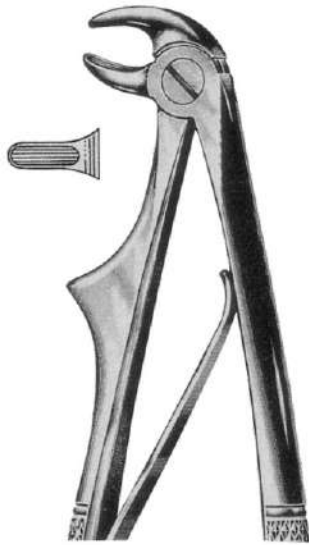

201-0082  
Fig. 5  
Lower incisors



201-0083  
Fig. 6  
Lower molars

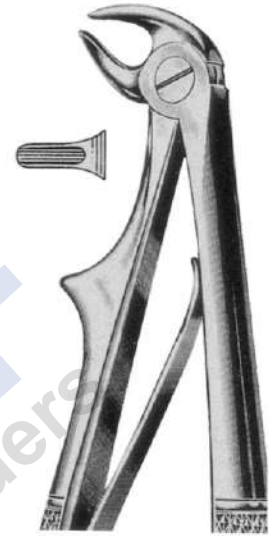

201-0084  
Fig. 7  
Lower roots

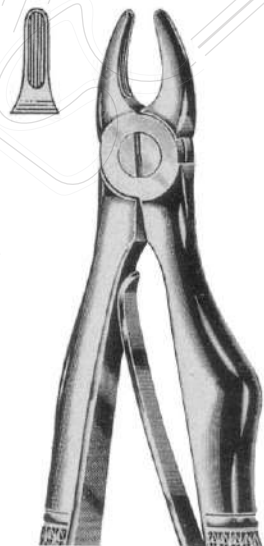

201-0085  
Fig. 137  
Upper incisors  
& canines



201-0086  
Fig. 139  
Upper premolars

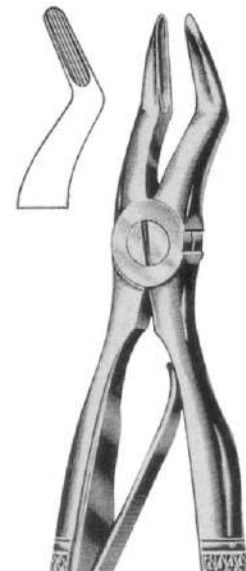

201-0087  
Fig. 51S  
Upper roots

## EXTRACTING FORCEPS ROOT FRAGMENT FORCEPS ●●●

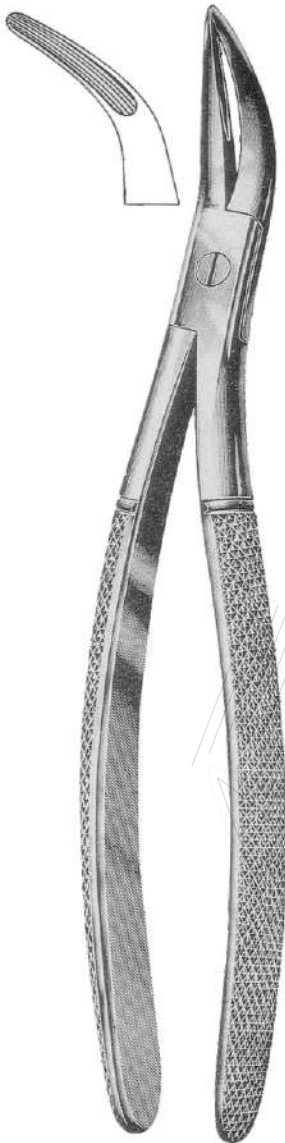

201-0088  
Universal pattern for upper teeth

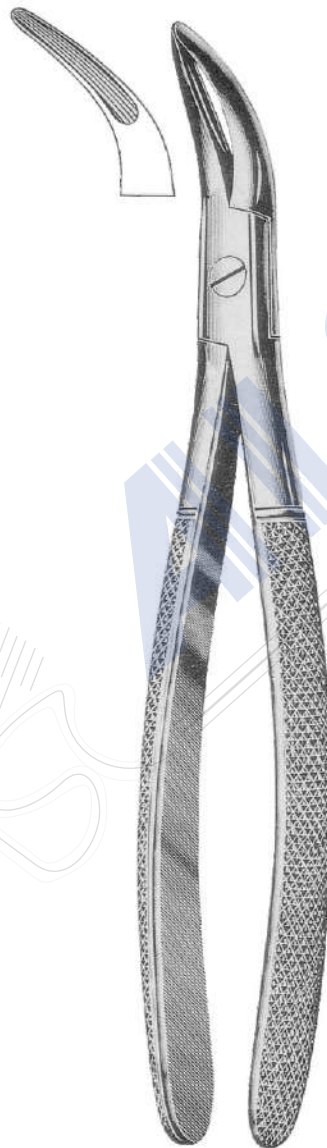

201-0089  
Universal pattern for lower teeth



201-0090  
Fig. 22 1/2L  
Left lower wisdoms & molars

201-0091  
Fig. 22 1/2R  
Right lower wisdoms & molars

●●● **EXTRACTING FORCEPS** AMERICAN PATTERN

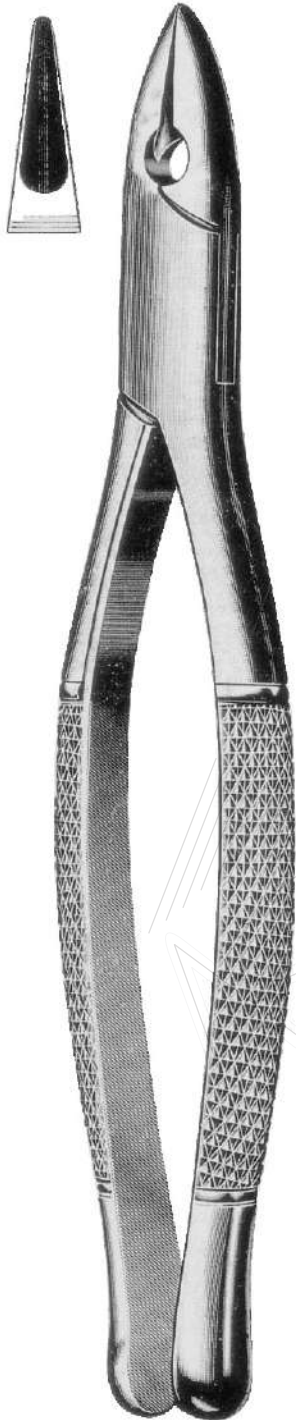

201-0092  
Fig. 1  
Upper centrals, laterals & cuspids

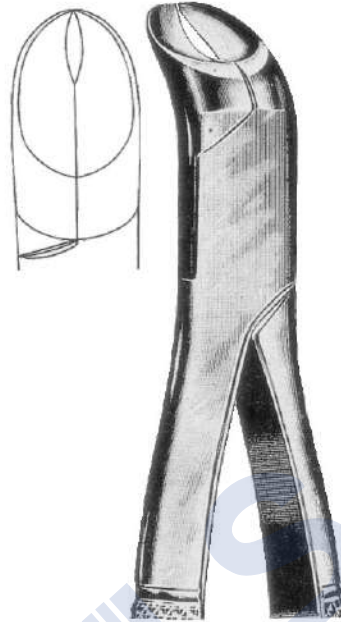

201-0093  
Fig. 5  
Lower third molars

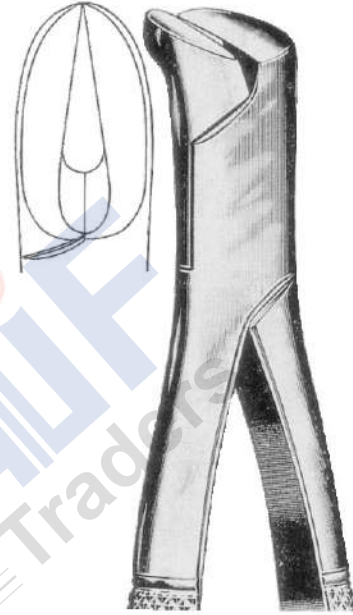

201-0094  
Fig. 6  
Splitting forceps

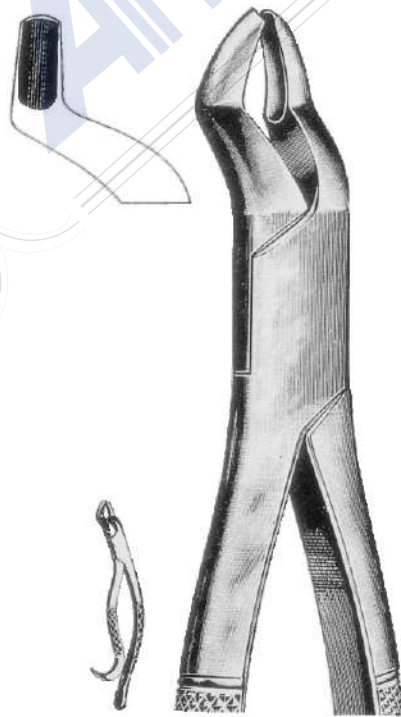

201-0095  
Fig. 10 H  
Upper molars hook-handle



201-0096  
Fig. 10 S  
Upper molars straight - handle

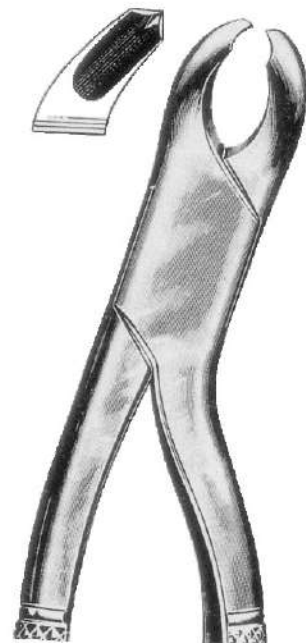

201-0097  
Fig. 15  
Lower molars

## EXTRACTING FORCEPS AMERICAN PATTERN ●●●



201-0098  
 Fig. 16 S  
 Lower molars children's



201-0099  
 Fig. 16  
 Lower molars (cow-horn beak)  
 201-0100  
 Fig.16 SK

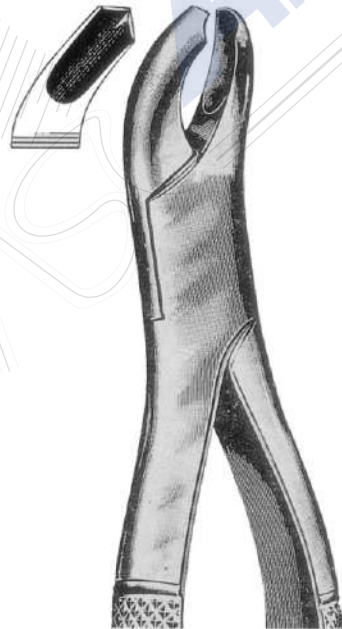

201-0105  
 Fig. 18R  
 Upper molars right side  
 201-0106  
 Fig.18R SK



201-0101  
 Fig. 17  
 Lower molars  
 201-0102  
 Fig.17 SK

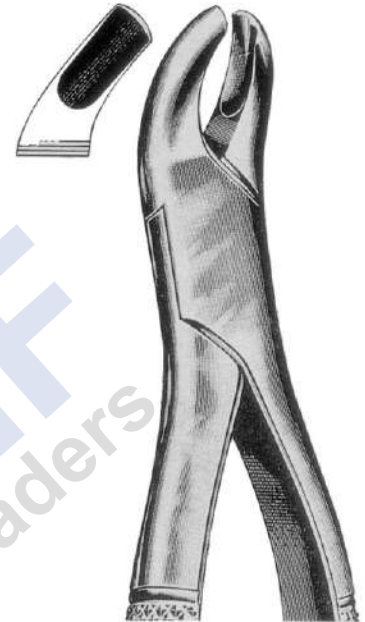

201-0103  
 Fig. 18L  
 Upper molars left side  
 201-0104  
 Fig.18L SK

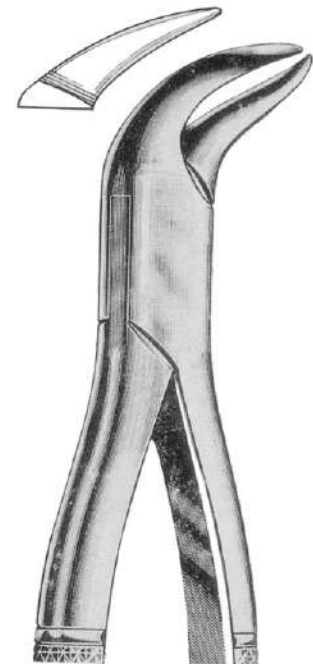

201-0107  
 Fig. 23  
 Lower molars (cow-horn beak)  
 201-0108  
 Fig.23 SK

## ●●● EXTRACTING FORCEPS AMERICAN PATTERN

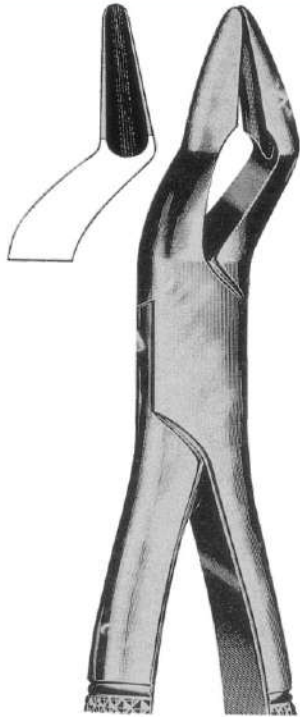

201-0109  
Fig. 32  
Upper molars & pre molars  
strong beak  
201-0110  
Fig. 32 SK

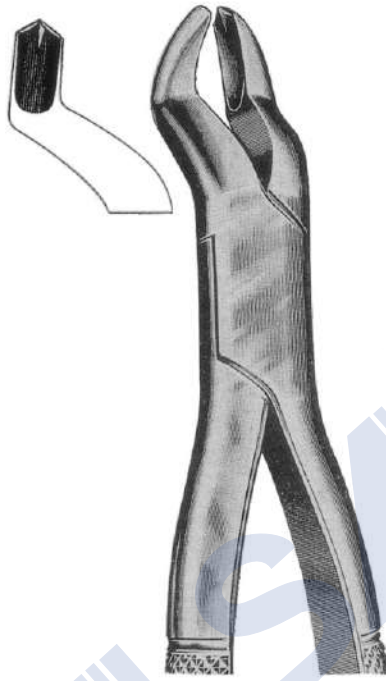

201-0111  
Fig. 53 L  
Upper molars left side  
201-0112  
Fig. 53 L SK

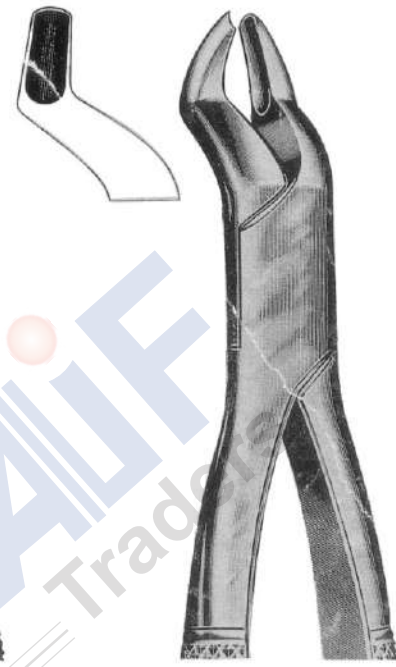

201-0113  
Fig. 53 R  
Upper molars right side  
201-0114  
Fig. 53R SK

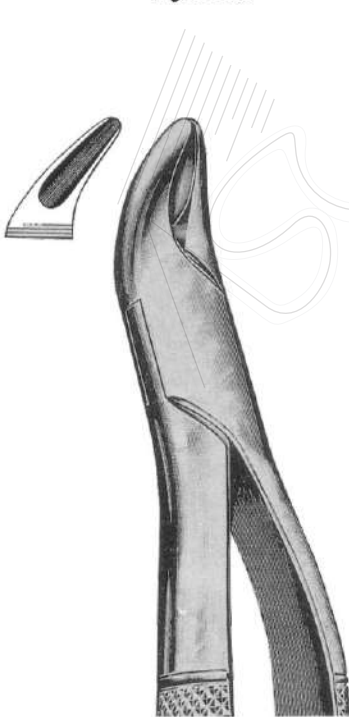

201-0115  
Fig. 62  
Universal forceps  
for upper teeth & roots  
201-0116  
Fig. 62 SK

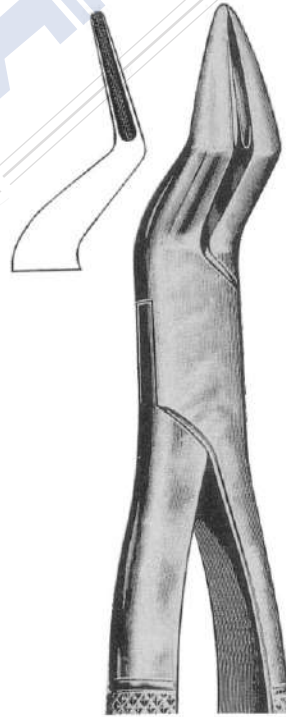

201-0117  
Fig. 65  
Upper Incisors & root  
201-0118  
Fig. 65 SK



201-0119  
Fig. 69  
Fragments & small roots  
Upper & lower  
201-0120  
Fig. 69 SK

## EXTRACTING FORCEPS AMERICAN PATTERN ●●●

### AMERICAN PATTERN

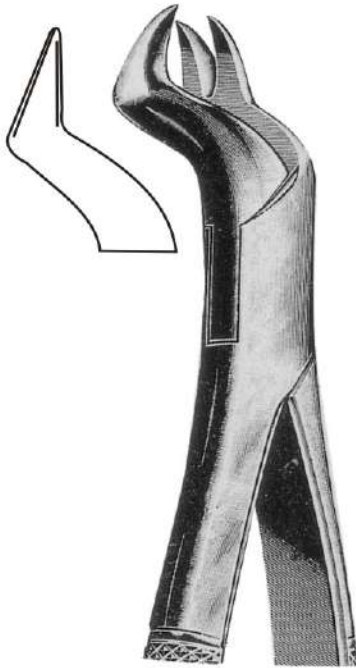

201-0121  
 Fig. 88 R  
 Right upper molars  
 201-0122  
 Fig. 88 R SK

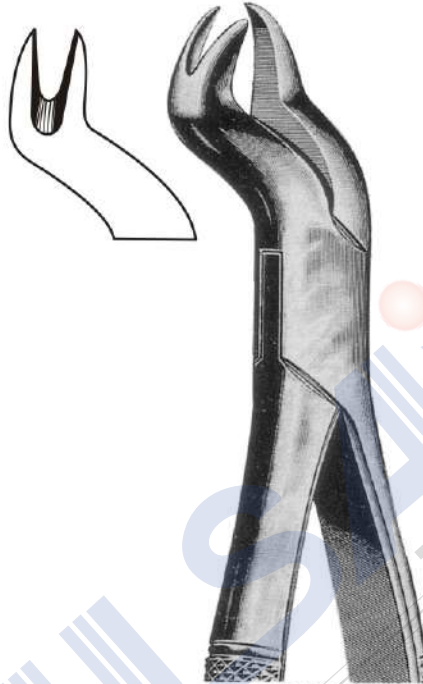

201-0123  
 Fig. 88L  
 Left upper molars  
 201-0124  
 Fig. 88L SK

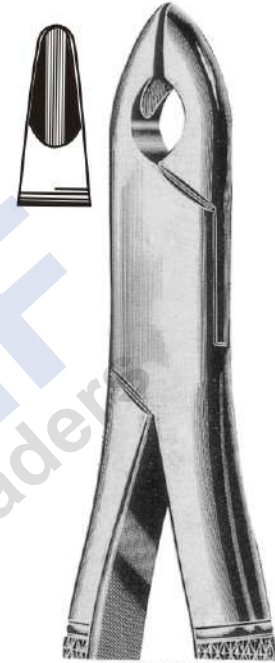

201-0125  
 Fig. 99C  
 Upper Premolars,  
 Molar & incisors  
 201-0126  
 Fig. 99C SK

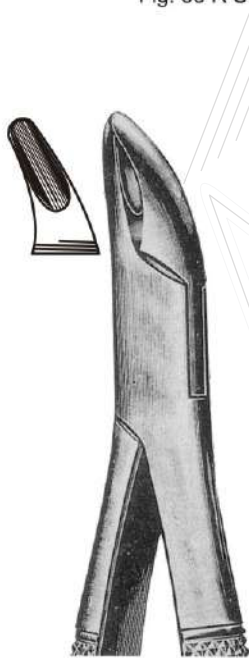

201-0127  
 Fig. 101  
 Universal forceps  
 for premolars  
 201-0128  
 Fig. 101 SK

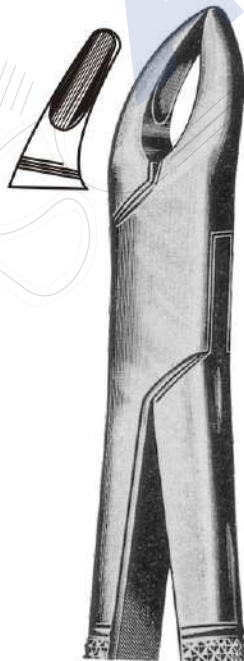

201-0129  
 Fig. 150  
 Upper premolars,  
 incisors & roots  
 201-0130  
 Fig. 150 SK

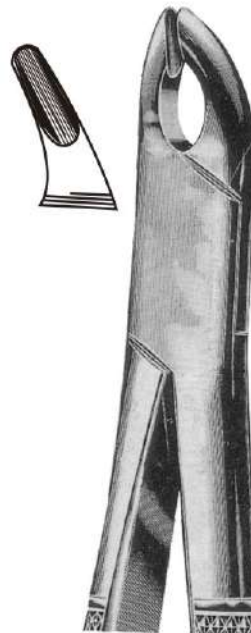

201-0131  
 Fig. 150A  
 Upper premolars incisors & roots  
 201-0132  
 Fig. 150A SK

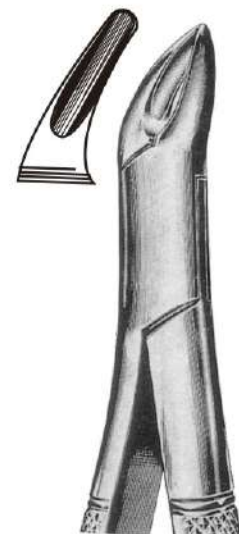

201-0133  
 Fig. 150S  
 Upper premolars incisors & roots  
 for children  
 201-0134  
 Fig. 150 SK

## ●●● EXTRACTING FORCEPS AMERICAN PATTERN

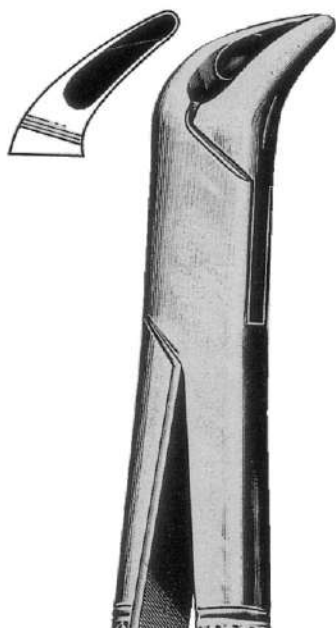

201-0135  
 Fig. 151  
 Lower premolars, incisors & roots  
 201-0136  
 Fig. 151 SK

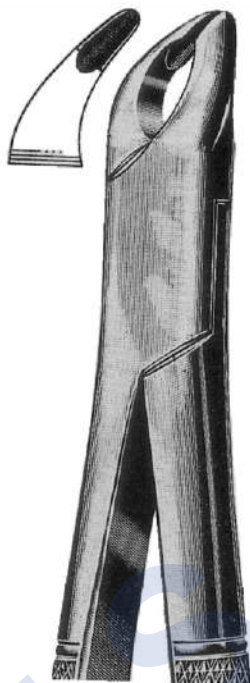

201-0137  
 Fig. 151A  
 Lower premolars, incisors & roots  
 201-0138  
 Fig. 151A SK



201-0139  
 Fig. 151S  
 Lower premolars, incisors & roots  
 for children's  
 201-0140  
 Fig. 151 SK

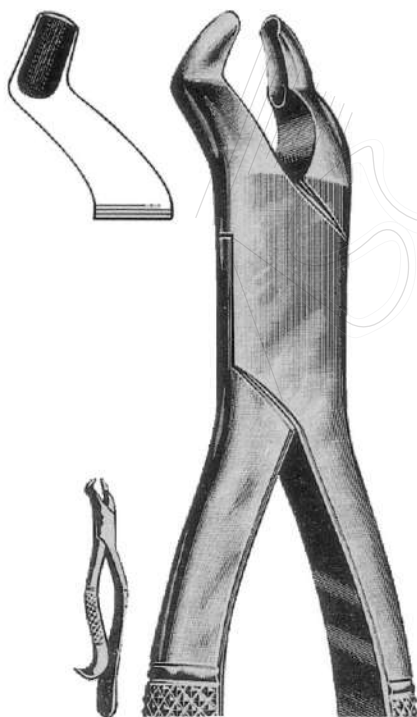

201-0141  
 Fig. 210H  
 Upper wisdoms with  
 hook handle  
 201-0142  
 Fig. 210H SK

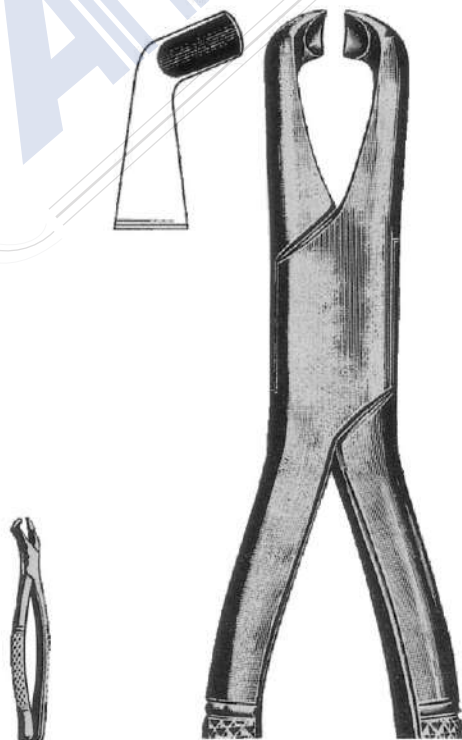

201-0143  
 Fig. 210S  
 Upper wisdoms with  
 straight handle  
 201-0144  
 Fig. 210 SK

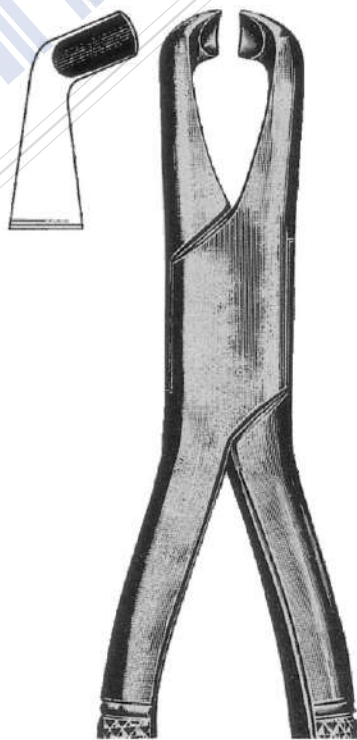

201-0145  
 Fig. 222  
 Lower wisdoms  
 201-0146  
 Fig. 222 SK

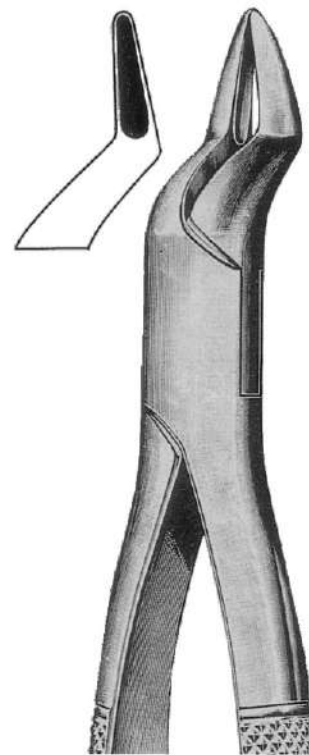

201-0147  
 Fig. 286  
 Upper roots, premolars & incisors  
 20-0148  
 Fig. 286 SK



## EXTRACTING FORCEPS EXTRACTION TWEEZER ●●●



201-0149  
Fig. 1  
Lower roots

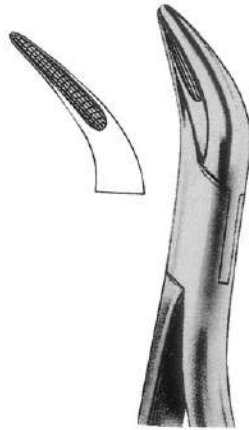

201-0150  
Fig. 2  
Upper roots



201-0151  
Fig. 44  
201-0152  
Fig. 44 SK



201-0153  
Albrecht 16cm



201-0154  
Albrecht 16cm

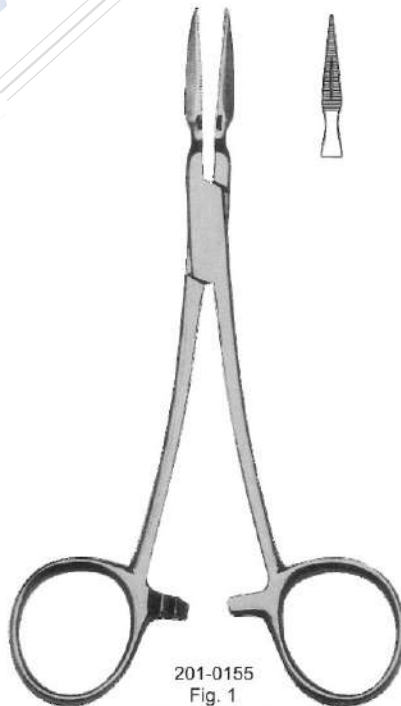

201-0155  
Fig. 1  
Root fragments



201-0156  
Fig. 2  
Root fragments

## ●●● PLIERS FOR ORTHODONTICS & PROSTHETICS



202-0001  
Waldsachs  
15cm



202-0002  
Universal  
16cm



202-0003  
Nance  
13.5



202-0004  
Aderer  
14.5cm

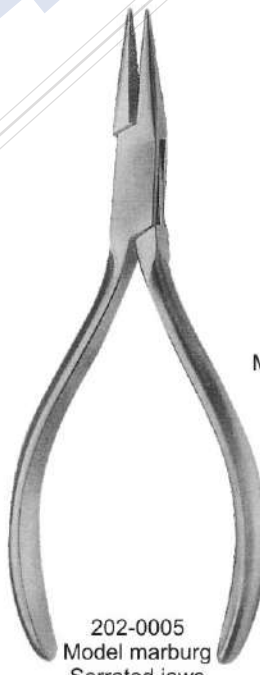

202-0005  
Model marburg  
Serrated jaws  
14cm

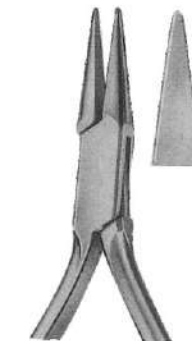

202-0006  
Model marburg  
Smooth jaws  
14cm

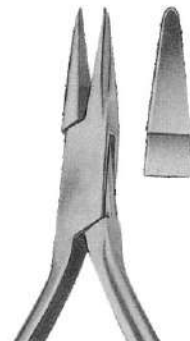

202-0007  
Model marburg  
Carbid inserts jaws  
14cm

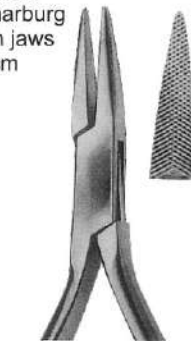

202-0008  
Goslee  
One Serrated jaws  
14cm

## PLIERS FOR ORTHODONTICS & PROSTHETICS ●●●

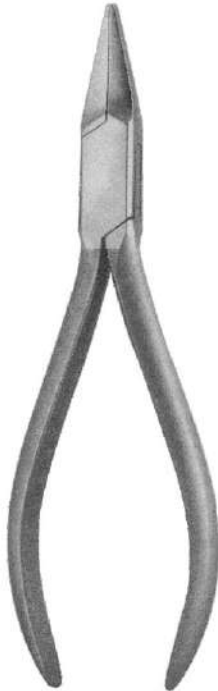

202-0009  
Flat Pliers  
14cm



202-0010  
14cm



202-0011  
14cm



202-0012  
14.5cm



202-0013  
14.5cm



202-0014  
14cm



202-0015  
14cm



202-0016  
14cm

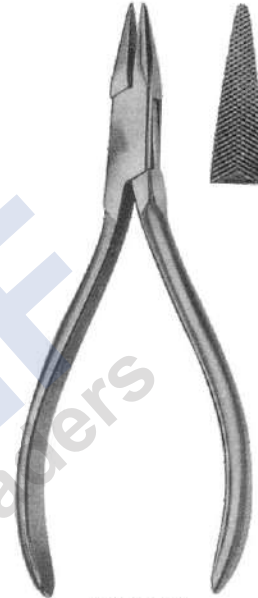

202-0017  
Serrated jaws  
12cm

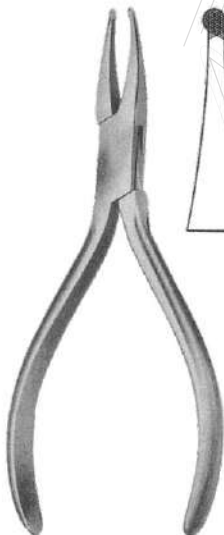

202-0018  
How  
14.5cm



202-0019  
How-angled  
14.5cm



202-0020  
Arrow clasp forming  
12cm

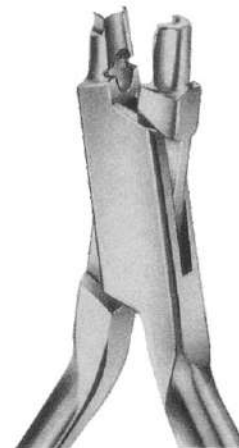

202-0021  
Arrow clasp forming  
12cm

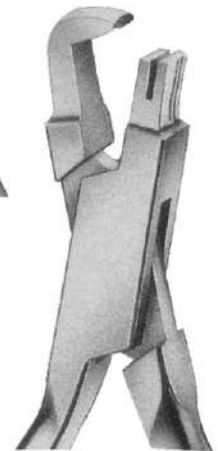

202-0022  
Arrow clasp bending  
12cm

## ●●● PLIERS FOR ORTHODONTICS & PROSTHETICS



202-0023  
Peeso  
13.5cm

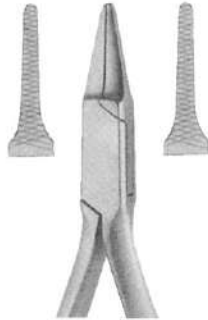

202-0024  
Peeso  
13.5cm



202-0025  
14cm



202-0026  
Langenbeck  
14cm

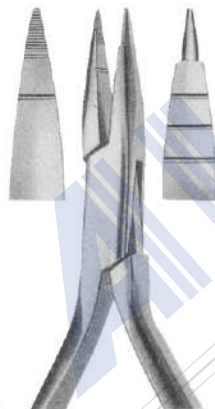

202-0027  
Jarabak  
14cm

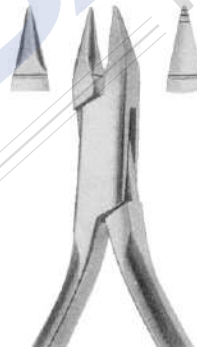

202-0028  
Bending Plier  
13cm



202-0029  
Angle  
12.5cm



202-0030  
Andresen  
13cm

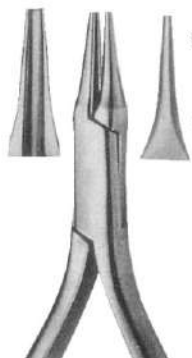
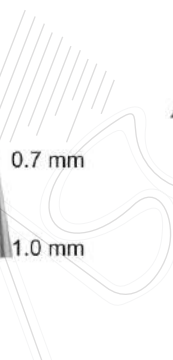

202-0031  
Bending Plier  
13.5cm

0.7 mm  
1.0 mm



202-0032  
Schwarz  
13.5cm

0.5 mm  
0.7 mm



202-0033  
Fischer  
13cm

0.8 mm  
1.0 mm

## PLIERS FOR ORTHODONTICS & PROSTHETICS ●●●

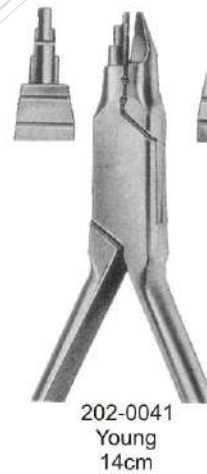
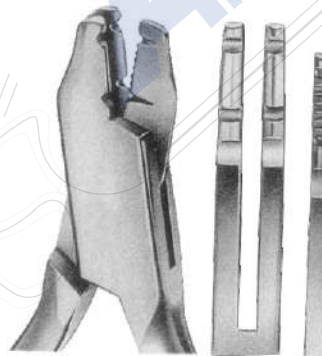
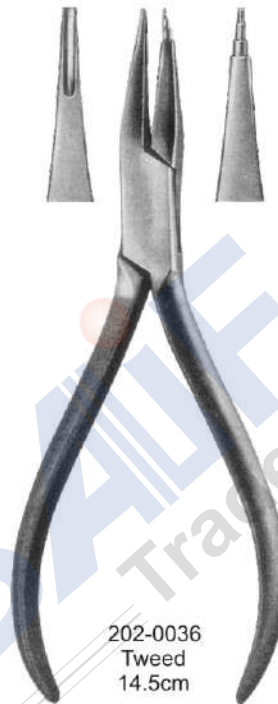

## ●●● PLIERS FOR ORTHODONTICS & PROSTHETICS



202-0043  
Hard Wire Cutter  
5 1/2" (14 cm)



202-0044  
Arch Forming Plier  
5 1/2" (14 cm)



202-0045  
Medium Size Bending Pliers  
5 1/2" (14 cm)

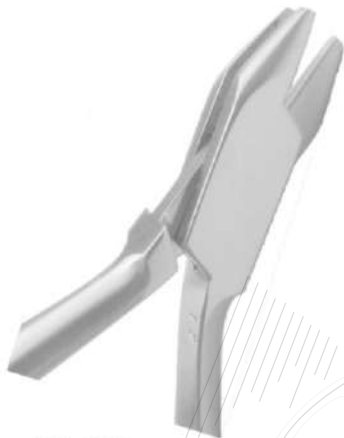

202-0046  
Aderer Pliers  
5 1/2" (14 cm)

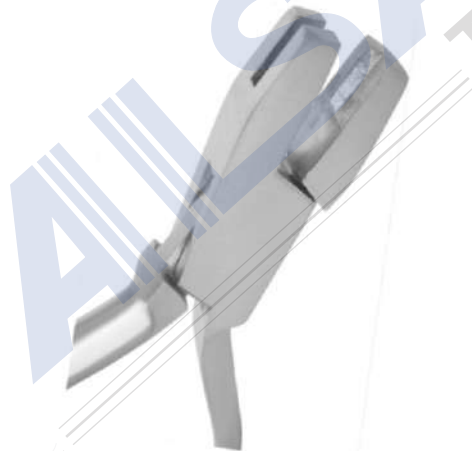

202-0047  
Wire Bending Plier  
5 1/2" (14 cm)



202-0048  
Round & Concave Plier  
5 1/2" (14 cm)

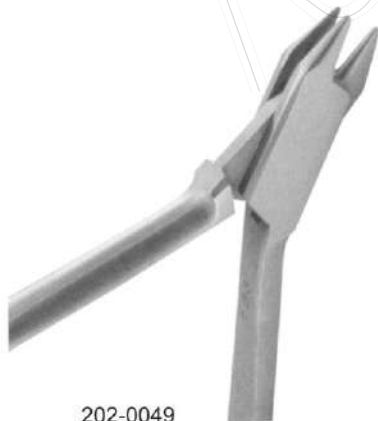

202-0049  
Aderer Pliers  
with narrow standing points,  
for bending wires up to  $\varnothing$  0.5mm,  
disinfectable, sterilizable  
4 3/4" (12cm)



202-0050  
Aderer Pliers  
for bending wires up to  $\varnothing$  0.9mm,  
disinfectable, sterilizable  
4 3/4" (12cm)



202-0051  
Bending plier for lingual cleat  
5 1/2" (14cm)

## PLIERS FOR ORTHODONTICS & PROSTHETICS ●●●



202-0052  
 Bracket Removing Pliers  
 5 1/2" (14 cm)



202-0053  
 Bracket Removing Pliers  
 5 1/2" (14 cm)

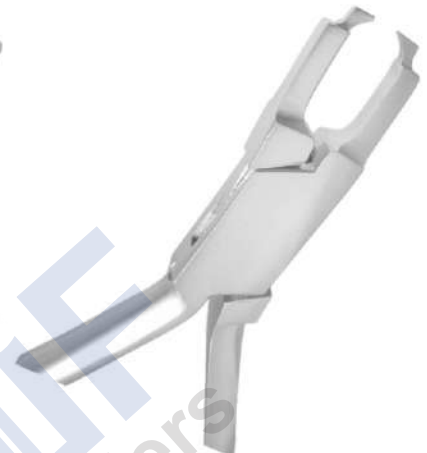

202-0054  
 Bracket Removing Pliers  
 5 1/2" (14 cm)

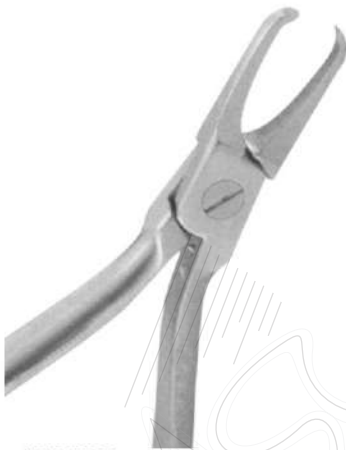

202-0055  
 Bracket Removing Pliers  
 5 1/2" (14 cm)

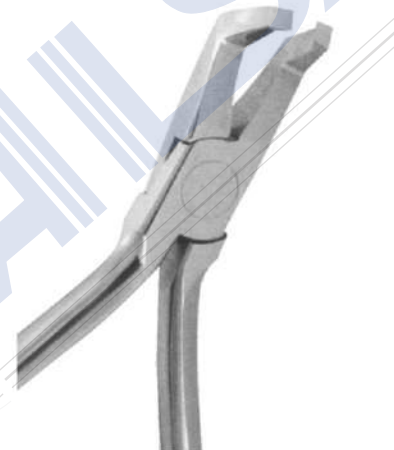

202-0056  
 Bracket Removing Pliers  
 5 1/2" (14 cm)



202-0057  
 Flat Pliers  
 5 1/2" (14 cm)



202-0058  
 Nance Closing Loop Pliers  
 5 1/2" (14 cm)



202-0059  
 Angle Bending Pliers  
 5 1/2" (14 cm)



202-0060  
 Crown Crimping Pliers  
 5 1/2" (14 cm)

## ●●● PLIERS FOR ORTHODONTICS & PROSTHETICS



202-0061  
Round & Flat Plier  
5 1/2" (14 cm)



202-0062  
Tweed Angle Arch Bending  
5 1/2" (14 cm)



202-0063  
Band Removing Pliers  
5 1/2" (14 cm)



202-0064  
Johnson Contouring Pliers  
5 1/2" (14 cm)

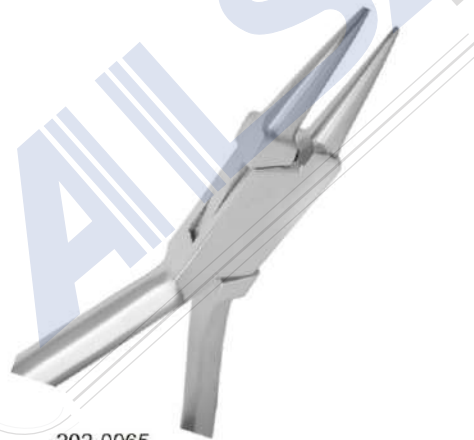

202-0065  
Round Nose Pliers  
5 1/2" (14 cm)



202-0066  
Tweed Angle Arch Bending  
5 1/2" (14 cm)



202-0067  
De La Rosa Pliers  
5 1/2" (14 cm)



202-0068  
Arch Forming Plier  
5 1/2" (14 cm)



202-0069  
Tweed Angle Arch Bending  
5 1/2" (14 cm)



## PLIERS FOR ORTHODONTICS & PROSTHETICS ●●●



202-0070  
 Flat Nose Plier  
 5 1/2" (14 cm)



202-0071  
 How Pliers  
 5 1/2" (14 cm)



202-0072  
 Gordon - Contouring  
 5 1/2" (14 cm)



202-0073  
 Adams Pliers  
 5 1/2" (14 cm)

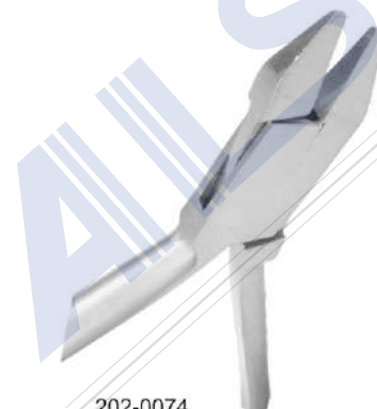

202-0074  
 Adams Pliers  
 5 1/2" (14 cm)



202-0075  
 Tweed Pliers  
 5 1/2" (14 cm)

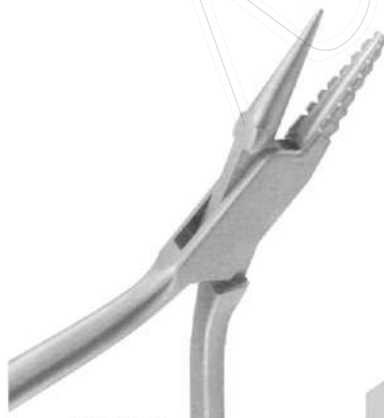

202-0076  
 Bending Pliers  
 mediumfine, with graduation,  
 for wires up to 1.0mm  
 5 1/2" (14cm)



202-0077  
 Special pliers  
 max .022"x .028"  
 5 1/2" (14cm)



202-0078  
 Pliers for operating the Mobil-Stop  
 5 1/2" (14cm)

## ●●● PLIERS FOR ORTHODONTICS & PROSTHETICS



202-0079  
Light wire pliers for wires  
up to  $\varnothing$  0.60mm  
with cutter Begg  
4  $\frac{3}{4}$ " (12cm)

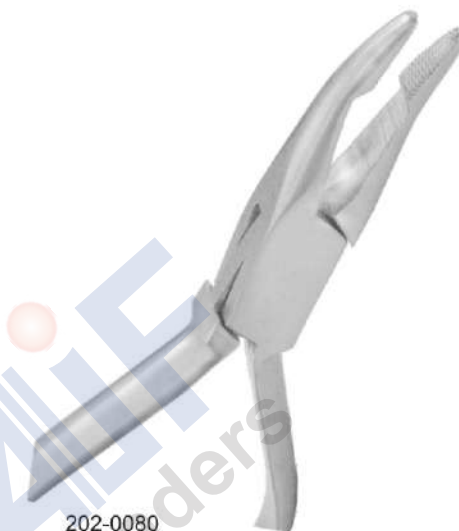

202-0080  
Weingart Universal Pliers  
5  $\frac{1}{2}$ " (14 cm)

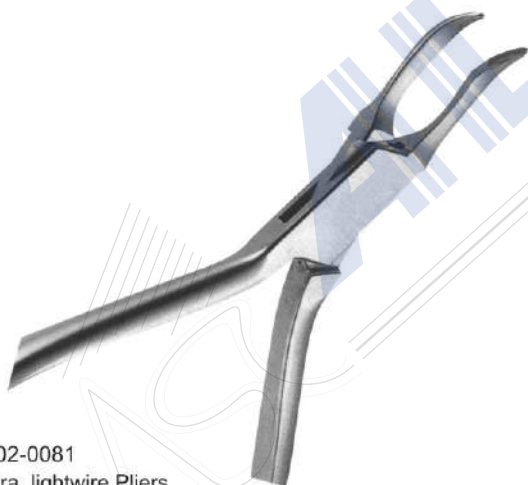

202-0081  
Weingart ultra lightwire Pliers  
5  $\frac{1}{2}$ " (14 cm)



202-0082  
Weingart Universal lightwire Pliers  
max .022" x .028  
5  $\frac{1}{2}$ " (14cm)



202-0083  
Universal Facebow Pliers  
6  $\frac{1}{2}$ " (16.5cm)

## CARBIDE INSERTED PLIERS ●●●



202-0084  
 Distal Cutter Light Weight  
 5 1/2" (14 cm)

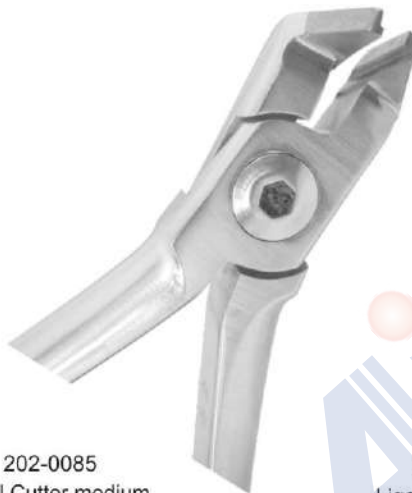

202-0085  
 Distal Cutter medium  
 5 1/2" (14 cm)



202-0086  
 Ligature Pin Cutter  
 5 1/2" (14 cm)



201-0087  
 Hard Wire Cutter  
 5 1/2" (14 cm)



202-0088  
 Hard Wire Cutter  
 5 1/2" (14 cm)



202-0089  
 Bracket Removing Pliers  
 5 1/2" (14 cm)



202-0090  
 Arch torquing and bending pliers  
 for wires up to  $\varnothing$  0.60mm  
 allow to user a pair  
 4 3/4" (12cm)

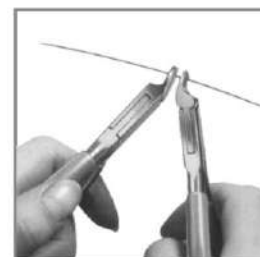

## ●●● BONE RONGEURS



203-0001  
**BEYER**  
 150mm (6")  
 5mm bite

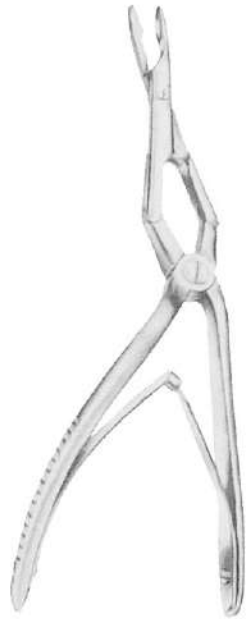

203-0002  
**JANSEN-MIDDLETON**  
**SEPTUM FORCEPS**  
 200mm (8") Spoon shaped  
 4mm bite



203-0003  
**CAIRNS**  
 140mm (5.1/2")  
 4mm bite



203-0004  
**CAIRNS**  
 140mm (5.1/2")  
 4mm bite



203-0005  
**LUER**  
 155mm (6")

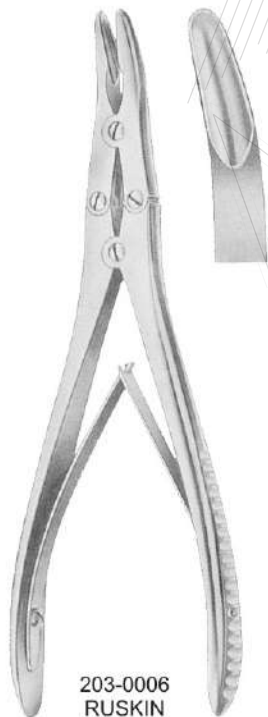

203-0006  
**RUSKIN**  
 190mm (7.1/2")  
 6mm bite

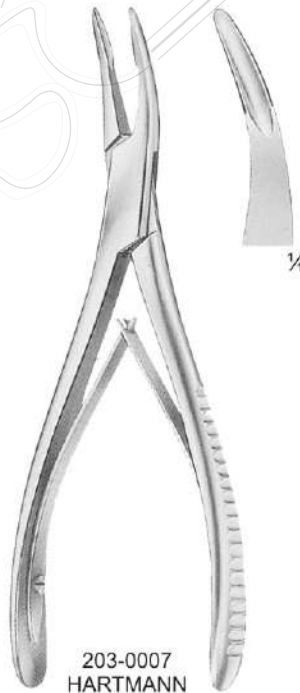

203-0007  
**HARTMANN**  
 180mm (7")



203-0008  
**MEAD**  
 165mm (6.1/2")



203-0009  
**JANSEN**  
 150mm (6")

## BONE RONGEURS ●●●



203-0010  
TROTTER  
200mm (8")  
10mm bite



203-0011  
SYNOVECTOMY  
RONGEUR  
175mm (7")

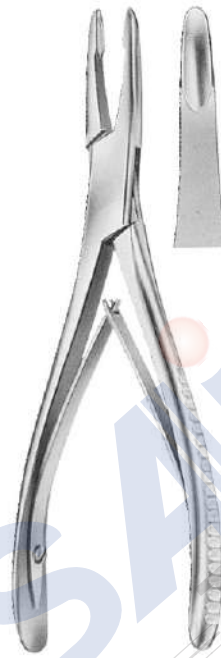

203-0012  
HEANLEY  
175mm (7")  
4mm bite

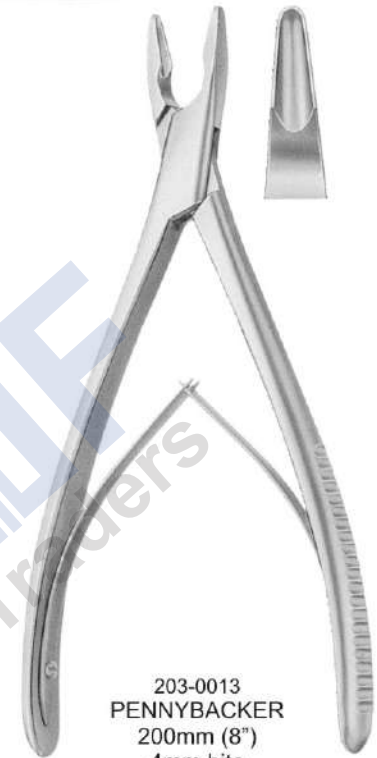

203-0013  
PENNYBACKER  
200mm (8")  
4mm bite

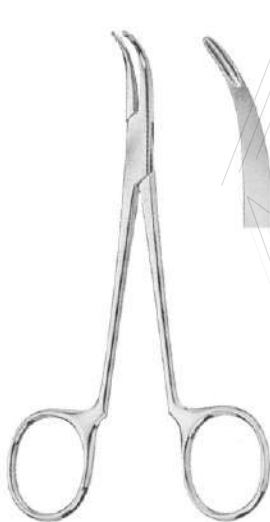

203-0014  
SYNOVECTOMY  
RONGEUR  
130mm (5.1/8")  
Jaw width 2mm



203-0015  
NORTHFIELD  
200mm (8")  
10mm bite



203-0016  
WILMS  
200mm (8")  
4mm bite

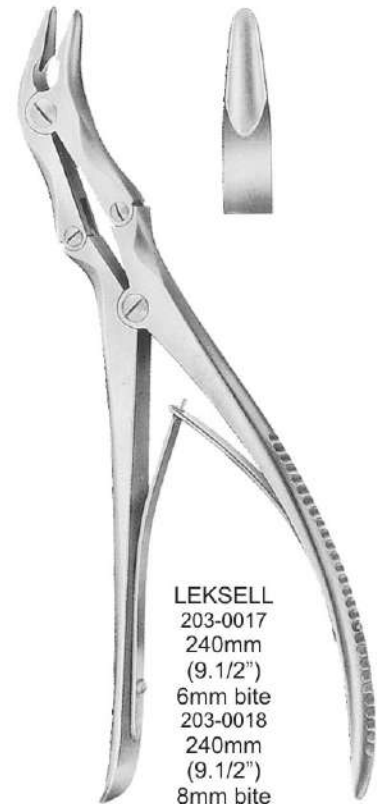

LEKSELL  
203-0017  
240mm  
(9.1/2")  
6mm bite  
203-0018  
240mm  
(9.1/2")  
8mm bite

## ●●● BONE RONGEURS

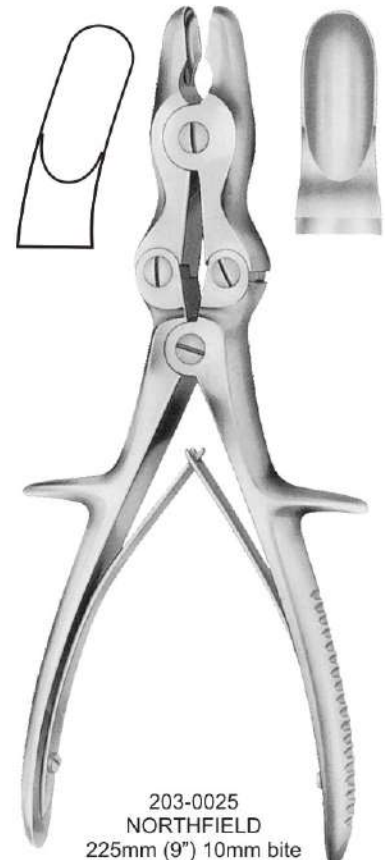
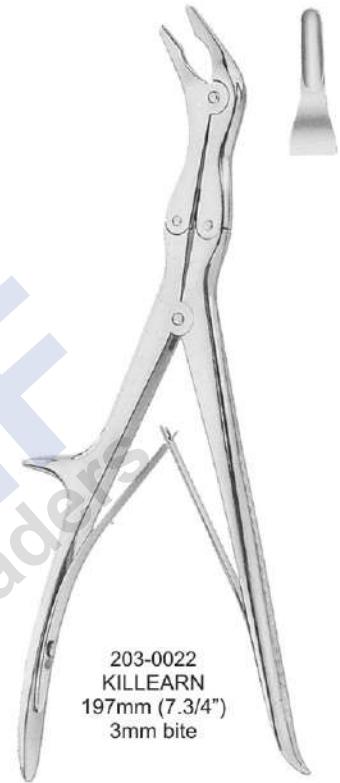
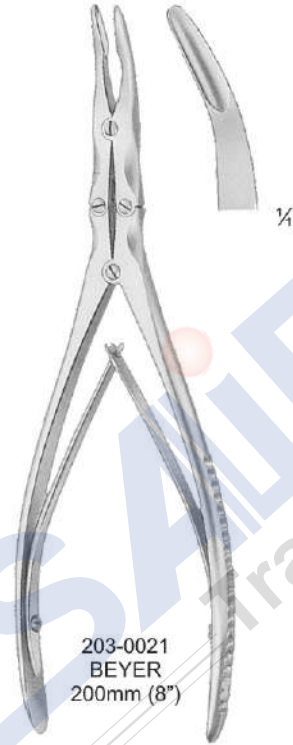

## BONE RONGEURS ●●●



203-0026  
**SARGENT (VAN HAVRE)**  
 220mm (8.3/4")  
 10mm bite



203-0027  
**OLIVECRONA**  
 230mm (9")  
 6mm bite

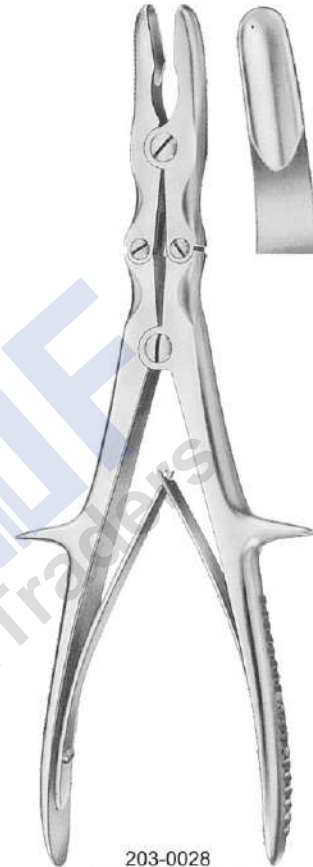

203-0028  
**STILLE-RUSKIN**  
 240mm (9.1/2")

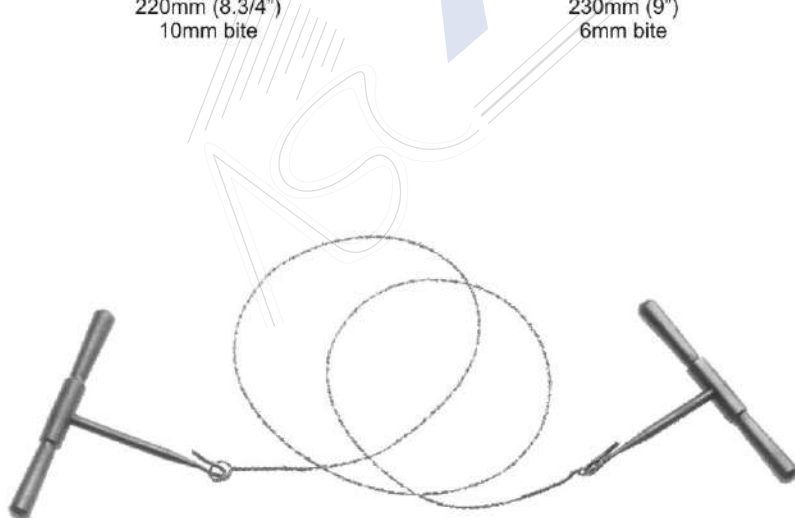

203-0029  
**GIGLI SAW WITH HANDLE**  
 500mm (20")

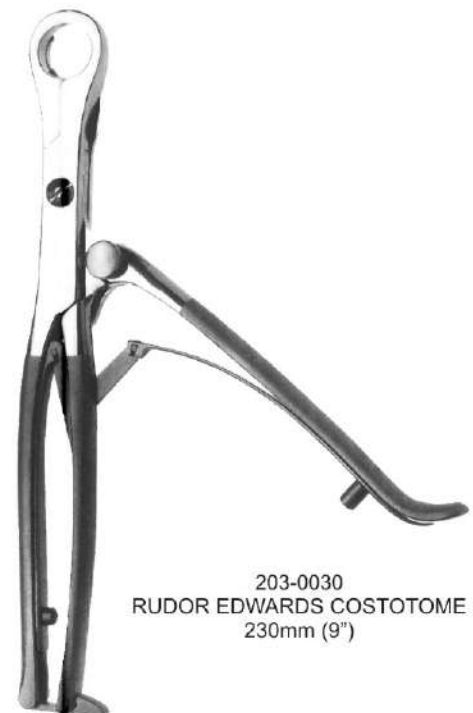

203-0030  
**RUDOR EDWARDS COSTOTOME**  
 230mm (9")

## ●●● ROOT ELEVATORS

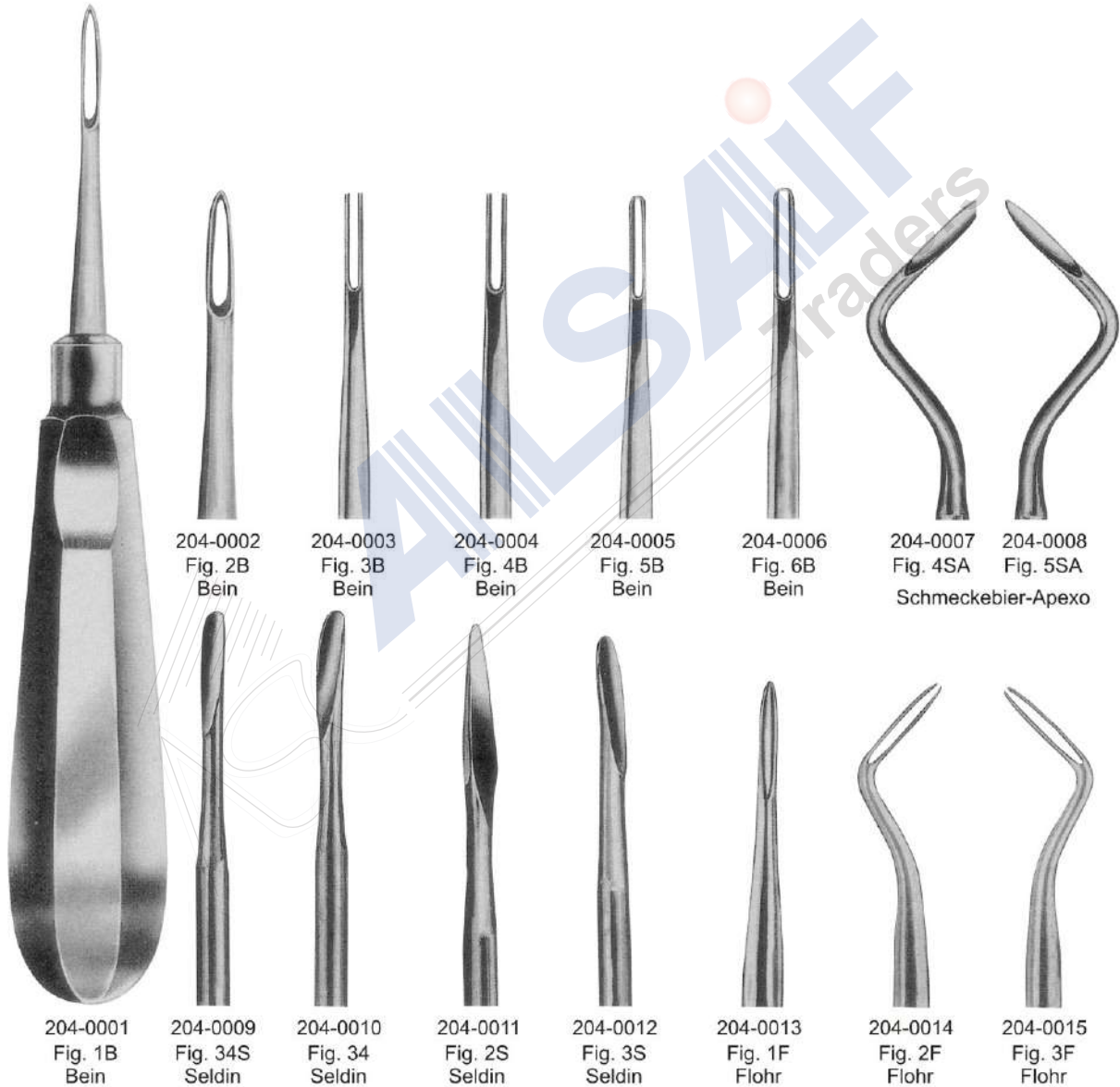



## ROOT ELEVATORS ●●●



## ●●● ROOT ELEVATORS



204-0031  
Fig. A  
Cogswell



204-0032  
Fig. B  
Cogswell



204-0033  
Fig. 301  
Apexo



204-0034  
Fig. 302  
Apexo



204-0035  
Fig. 303  
Apexo



204-0036  
Fig. 301W  
Seldin



204-0037  
Fig. 304W  
Seldin



204-0038  
Fig. 1H  
Heidbrink



204-0039  
Fig. 2H  
Heidbrink



204-0040  
Fig. 40H  
Heidbrink



204-0041  
Fig. 41H  
Heidbrink



204-0042  
Fig. 46



204-0043  
Fig. 46R

## ROOT ELEVATORS ●●●



## ●●● ROOT ELEVATORS



## ROOT ELEVATORS ●●●



204-0075  
Fig. 1  
Bein



204-0076  
Fig. 2  
Bein



204-0077  
Fig. 3  
Bein



204-0078  
Fig. 4  
Bein



204-0079  
Fig. 5  
Bein



204-0080  
Fig. 6  
Bein



204-0081  
Fig. 1



204-0082  
Fig. 2



204-0083  
Fig. 2  
Flohr



204-0084  
Fig. 3  
Flohr



204-0085  
Fig. 3  
Cryer



204-0086  
Fig. 8  
Cryer

## ●●● ROOT ELEVATORS

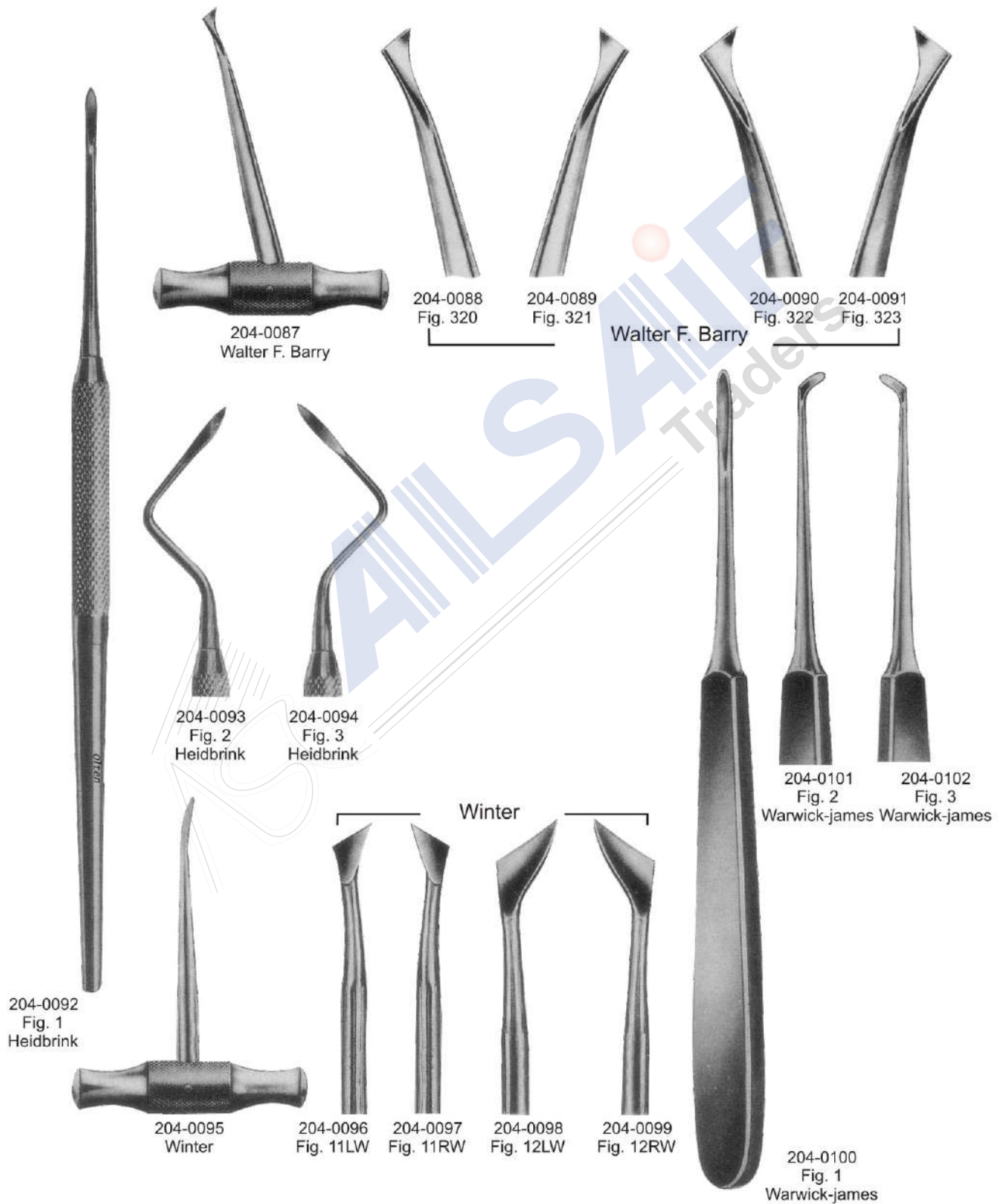

## ORTHODONTICS INSTRUMENTS ●●●



205-0001  
205-0002  
Band seating & removing instruments

205-0003  
205-0004  
Elastic instruments

205-0005  
Mershon band pusher  
14cm

205-0006  
Band setter with tin insert  
15cm

205-0007  
13.5 cm

205-0008  
14cm

205-0009  
Separating Pliers for separators  
15.5cm

## ●●● ORTHODONTICS INSTRUMENTS



205-0010  
Mathieu pliers  
14cm



205-0011  
Elastic ligature placing pliers  
14cm

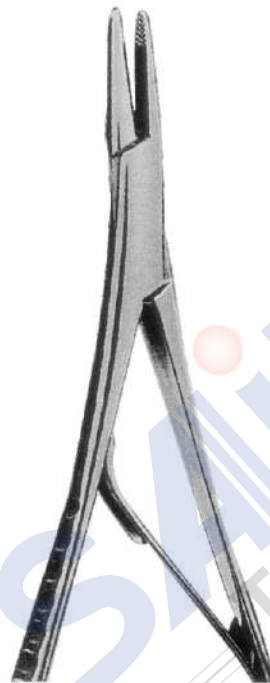

205-0012  
Mathieu ligating pliers  
14cm



205-0013  
Mathieu pliers  
with finger ring  
14cm

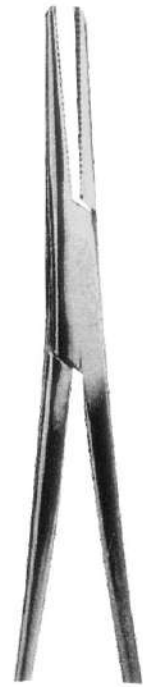

205-0014  
Straight 5"  
Mosquito Forceps  
205-0015  
Curved 5"

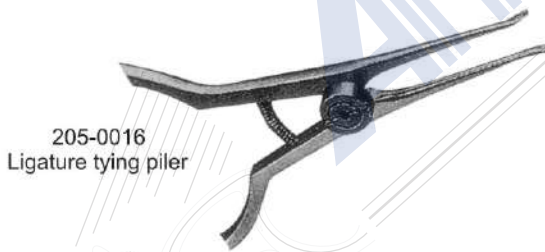

205-0016  
Ligature tying piler



205-0017  
Bracket positioning gauge

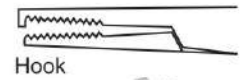

Hook



205-0023  
Straight 5"  
Mosquito Forceps  
205-0024  
Curved 5"



205-0018  
Bracket placing  
tweezer



205-0019  
Bracket placing  
tweezer



205-0020  
Clamping  
Tweezer



205-0021  
Bracket holding  
tweezer



205-0022  
Band seating  
instruments  
nylon



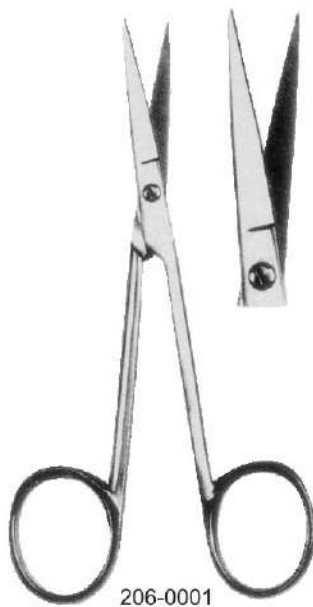

206-0001  
Fig. 1  
12cm Straight



206-0002  
Fig. 2  
12cm curved

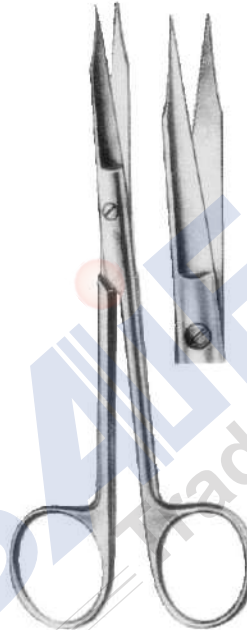

206-0003  
Fig. 1  
13cm  
Goldman-Fox  
Saw edge  
Straight

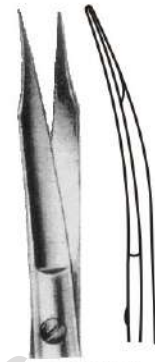

206-0004  
Fig. 2  
13cm  
Goldman-Fox  
Saw edge  
curved

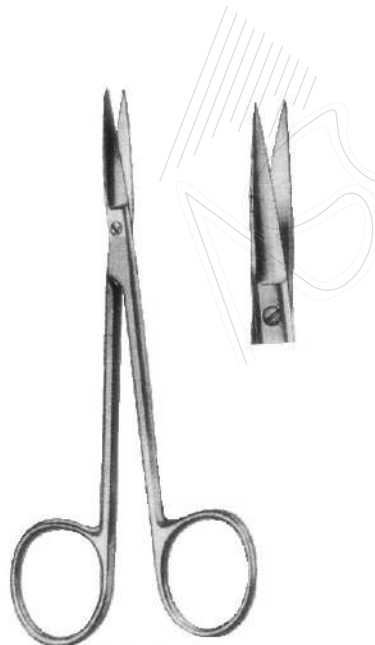

206-0005  
Fig. 1  
11.5cm  
Iris Straight



206-0006  
Fig. 2  
11.5cm  
Iris  
Curved



206-0007  
Fig. 3  
11.5cm  
Iris



206-0008  
Fig. 1  
11.5cm  
Angular Saw edge



206-0009  
Fig. 2  
11.5cm  
Angular

## ●●● GUM SCISSORS



206-0010  
Fig. 1  
La Grange  
11.5cm

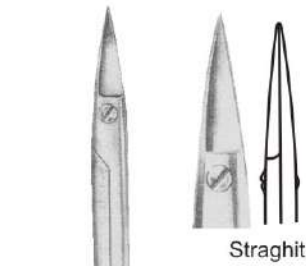

Straghit

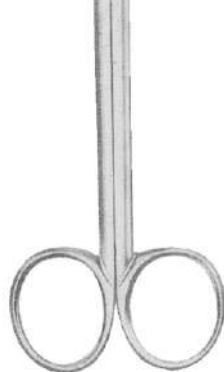

206-0011  
Fig. 1  
Quinby  
12.5cm

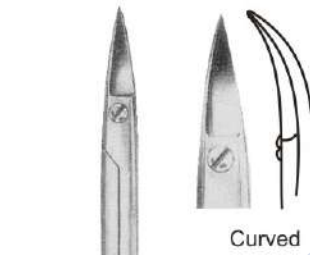

Curved

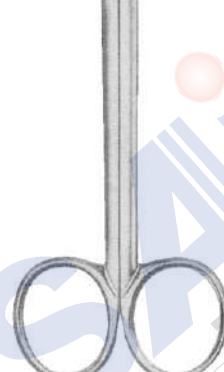

206-0012  
Fig. 2  
Quinby  
12.5cm

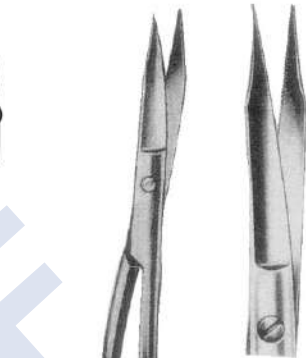

206-0013  
Fig. 3  
Goldman-Fox (Special)  
saw edge  
12.5cm

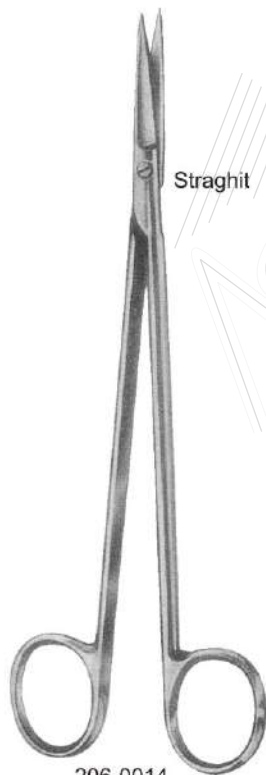

Straghit

206-0014  
Fig. 1  
Kelly  
16cm

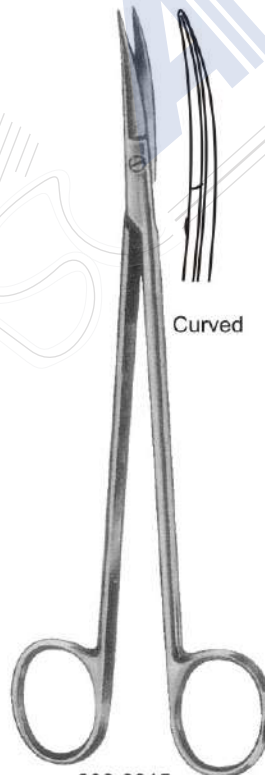

Curved

206-0015  
Fig. 2  
Kelly  
16cm



Saw edge

206-0016  
Fig. 1  
Locklin  
16.5 cm

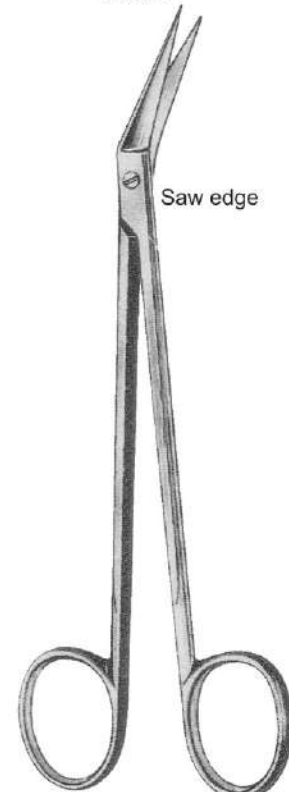

Saw edge

206-0017  
Fig. 2  
Locklin  
16.5cm

## SURGICAL SCISSORS ●●●

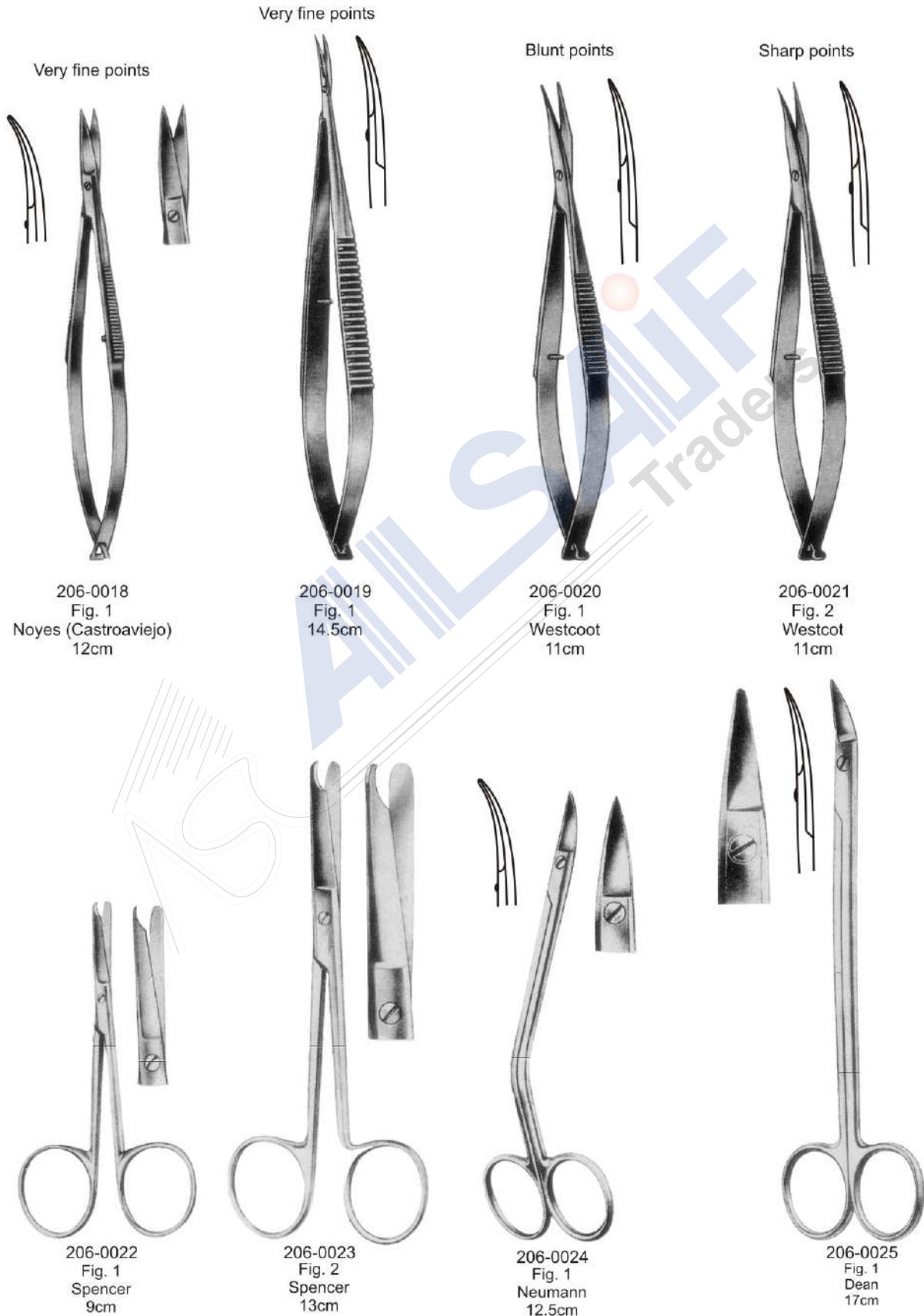

## ●●● SURGICAL SCISSORS



206-0026  
Fig. 1  
Mayo  
14.5cm

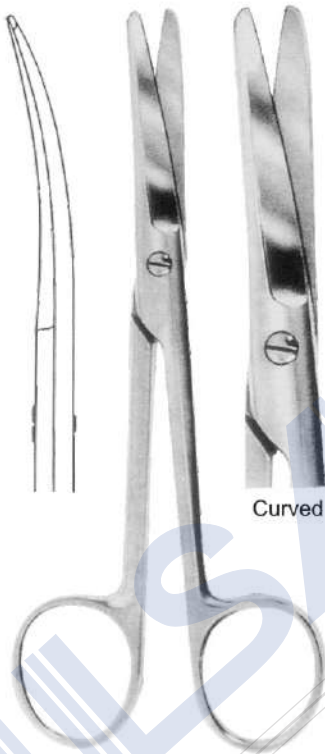

206-0027  
Fig. 2  
Mayo  
14.5cm

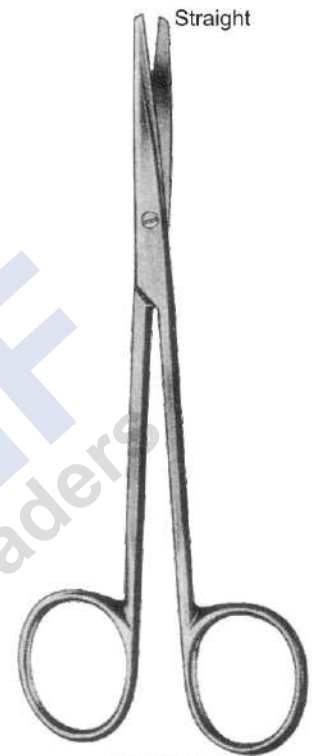

206-0028  
Fig. 2  
Metzenbaum  
14.5cm

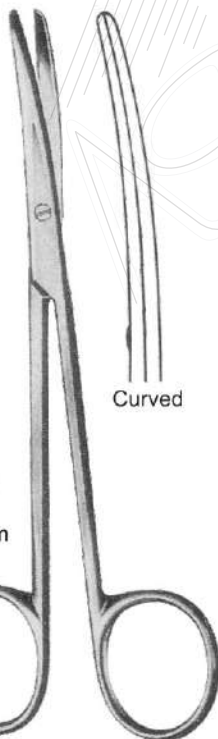

206-0029  
Fig. 2  
Metzenbaum  
14.5cm

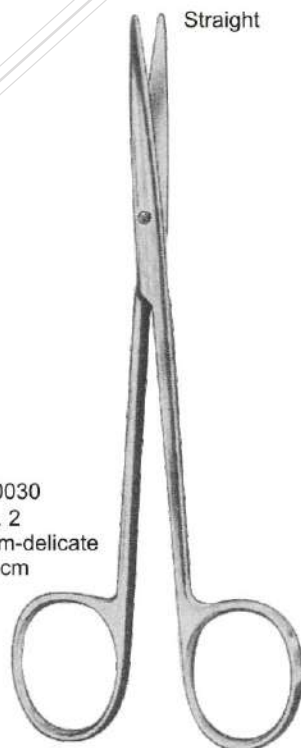

206-0030  
Fig. 2  
Metzenbaum-delicate  
14.5cm

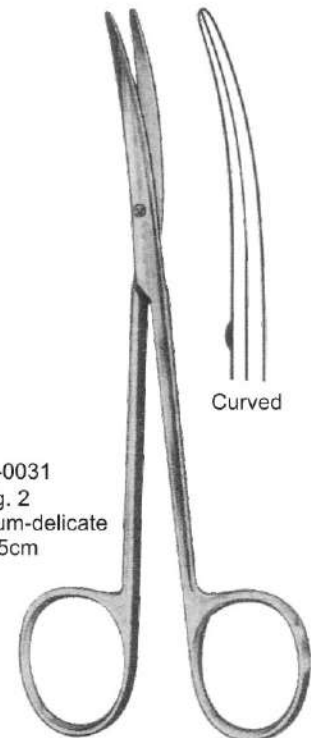

206-0031  
Fig. 2  
Metzenbaum-delicate  
14.5cm

## HAEMOSTATIC FORCEPS ●●●

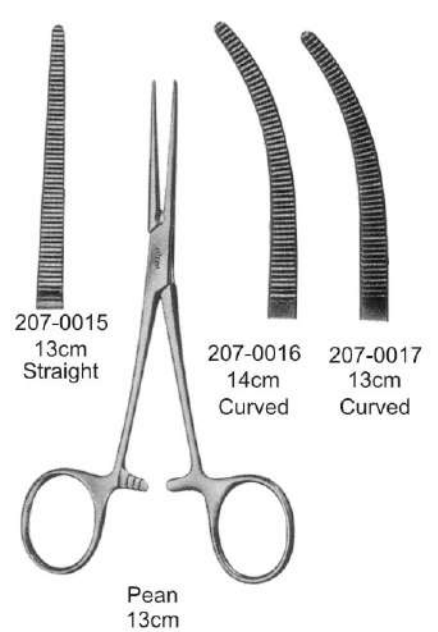
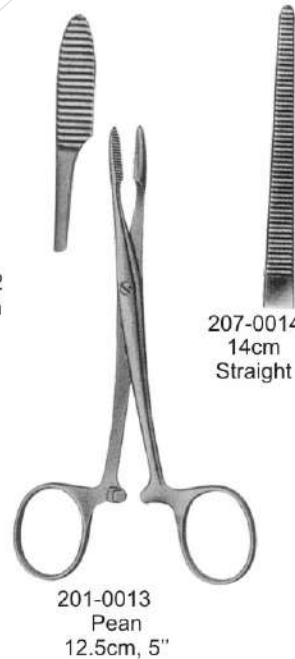
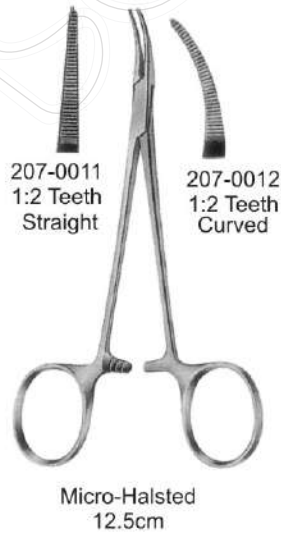
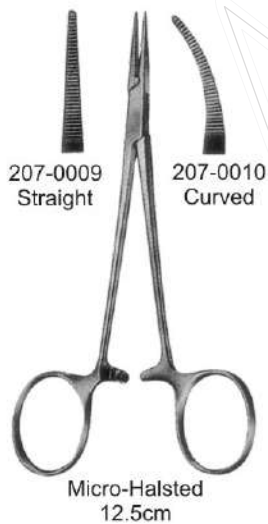
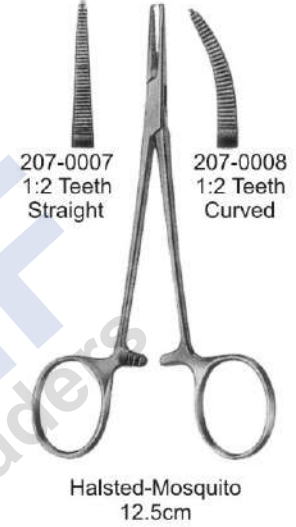
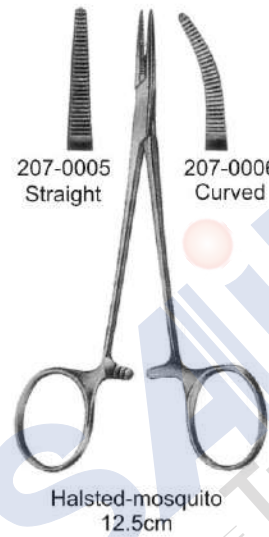

## ●●● HAEMOSTATIC FORCEPS

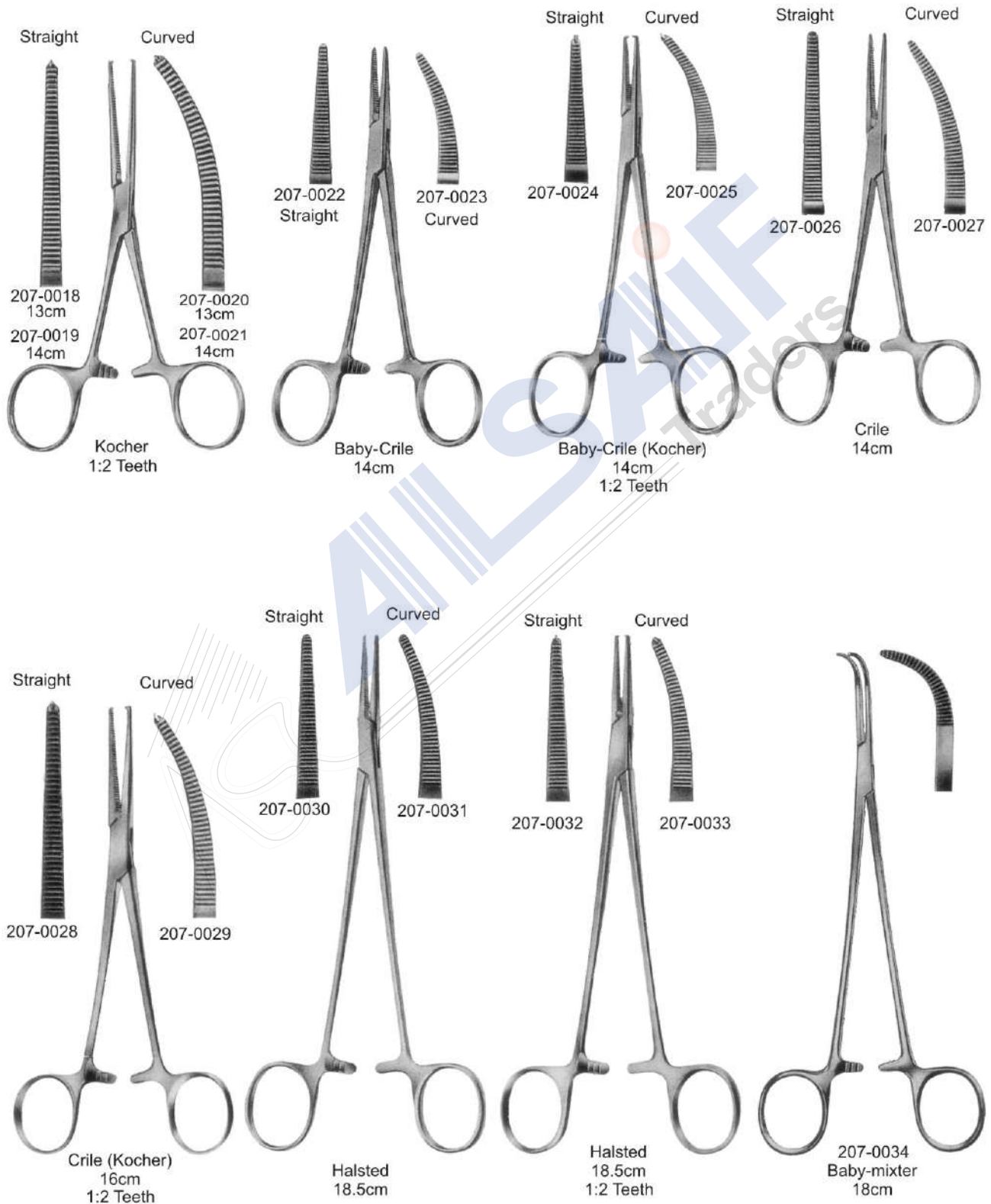

## SPONGE AND DRESSING FORCEPS ●●●

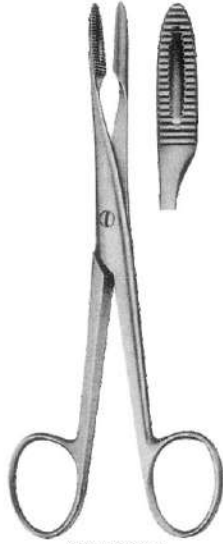

207-0035  
Without Ratchet  
14.5cm



207-0036  
With Ratchet  
14.5cm

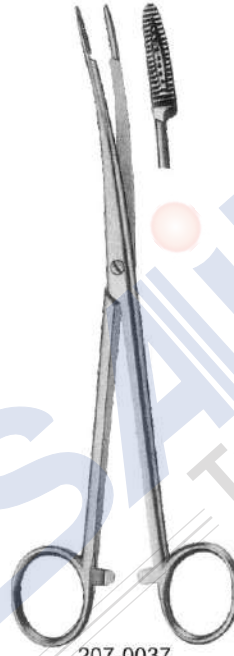

207-0037  
Curved  
17.5cm

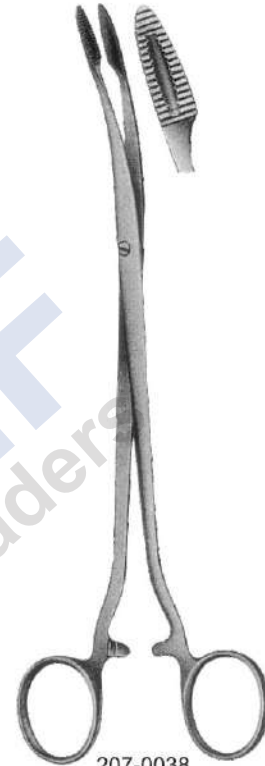

207-0038  
Curved  
21cm



207-0039  
Straight

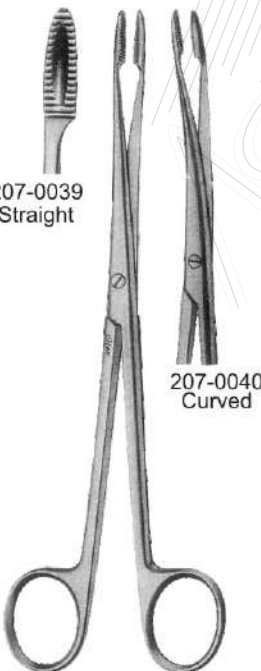

207-0040  
Curved

Without Ratchet  
18cm

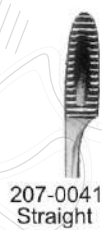

207-0041  
Straight

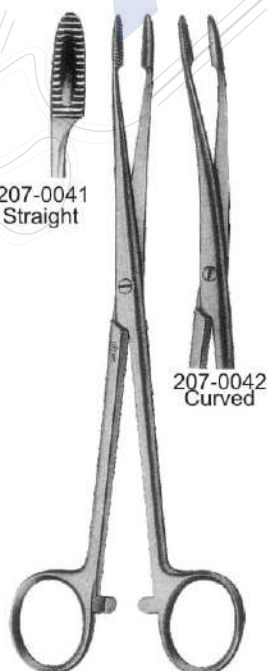

207-0042  
Curved

With Ratchet  
18cm



207-0043  
Straight

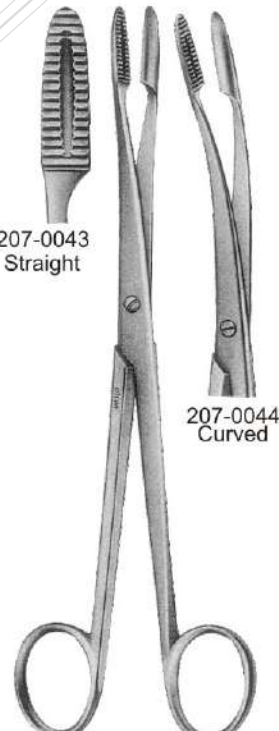

207-0044  
Curved

Without Ratchet  
20cm



Straight  
207-0045

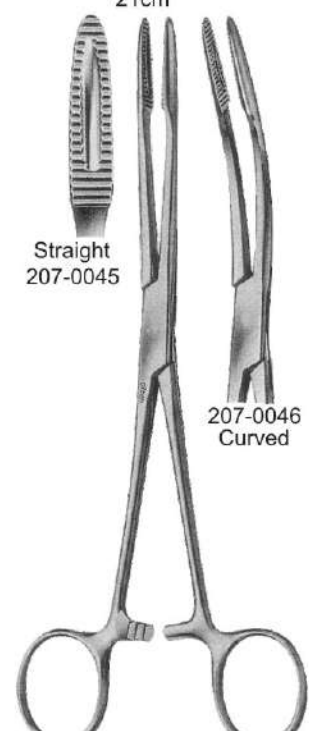

207-0046  
Curved

With Ratchet  
20cm

●●● **TOWEL CLAMPS** Sterilizing Forceps For Sterile Instruments

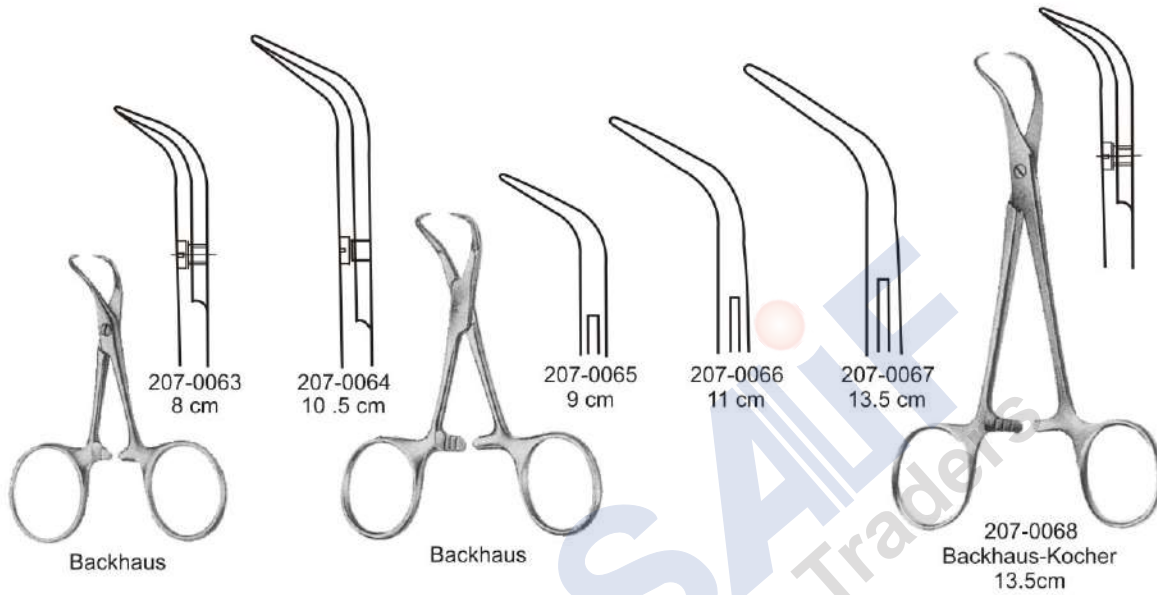





## RETRACTORS

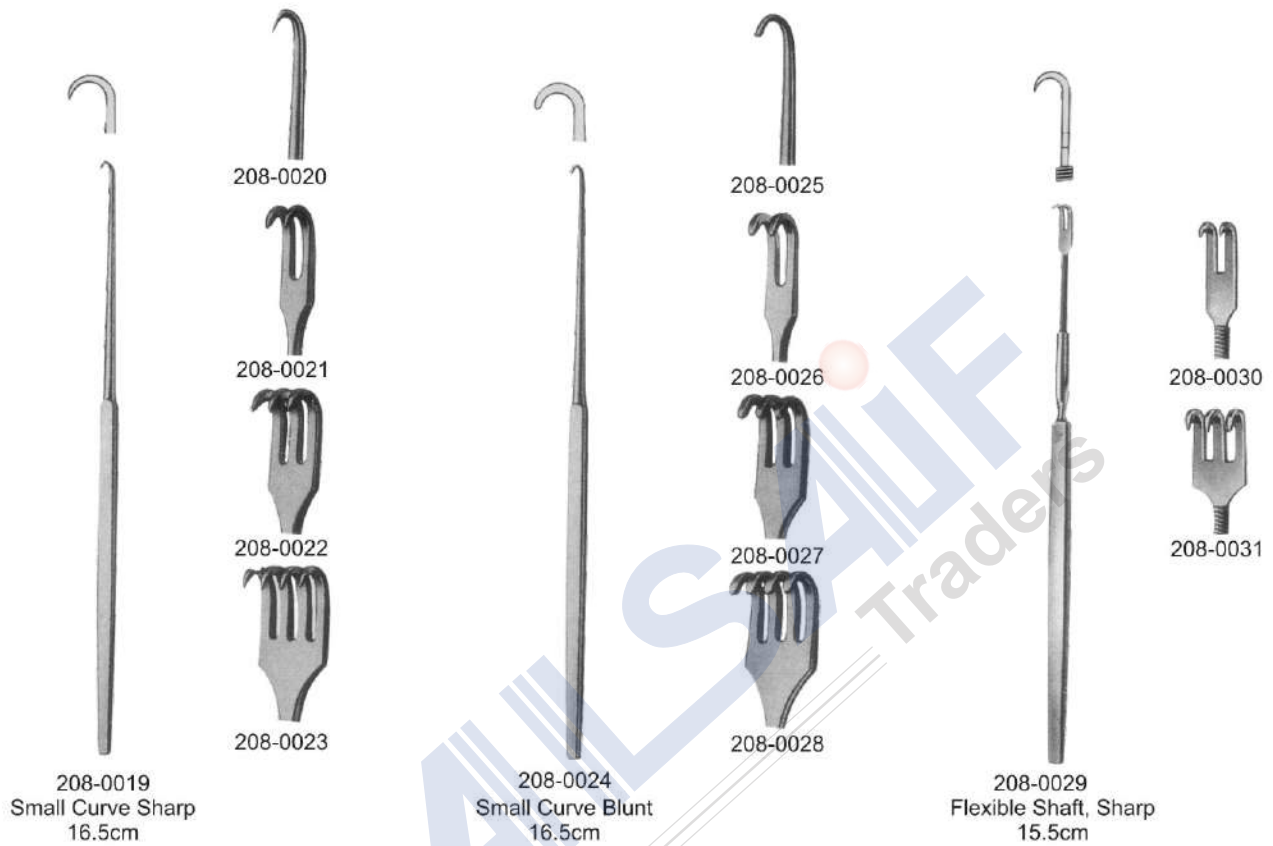

## RETRACTORS ●●●

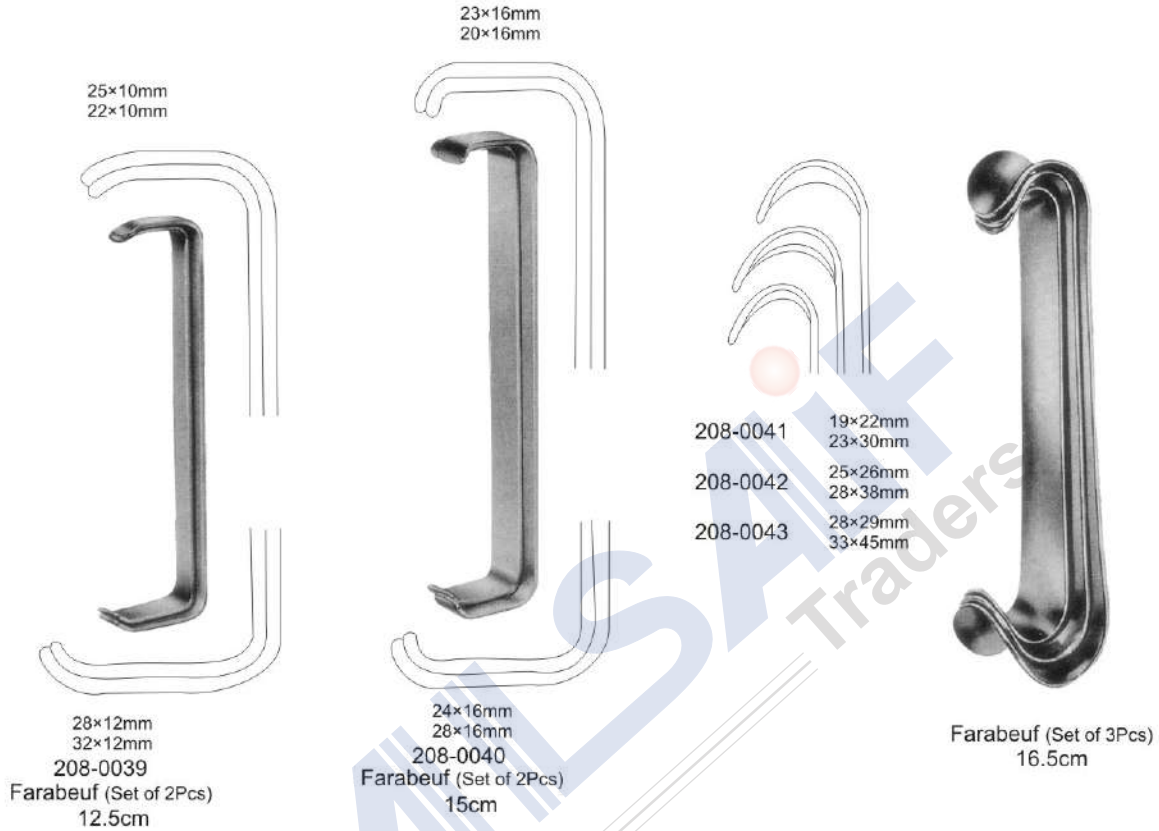

## ●●● CHEEK RETRACTORS



Middeldorpf



208-0053  
15×15mm  
22cm



208-0054  
20×22mm  
21.5cm



208-0055  
28×28mm  
23.5cm



208-0056  
Greene  
22.5cm

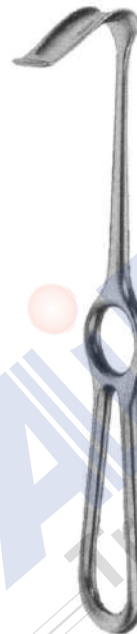

208-0057  
Buchs  
20.5cm



208-0058  
28×10mm



208-0059  
28×14mm



208-0060  
33×14mm



208-0061  
28×16mm

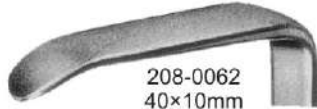

208-0062  
40×10mm

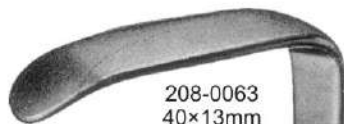

208-0063  
40×13mm



Langenbeck  
21cm

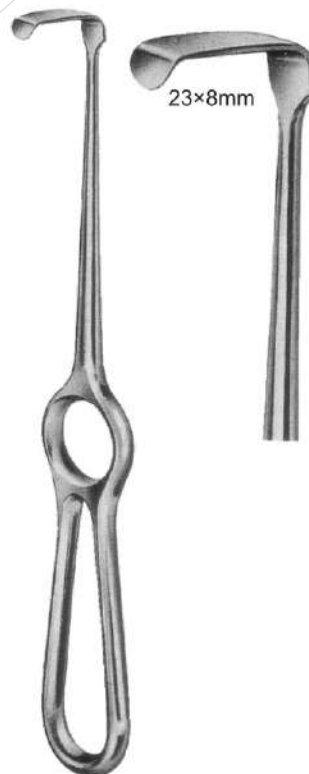

208-0064  
Kocher  
21cm



208-0065  
Alm (Sharp)  
7cm



208-0066  
Blunt



208-0067  
Alm (Sharp)  
10cm



208-0068  
Blunt

## ELEVATORS ●●●

5mm

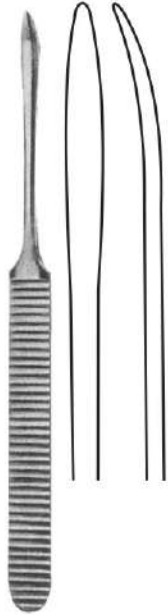

208-0069  
Williger  
16.5cm

6mm

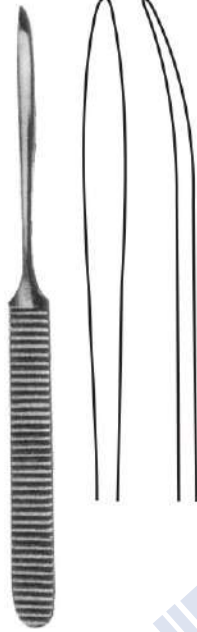

208-0070  
Williger  
17cm

4.5mm

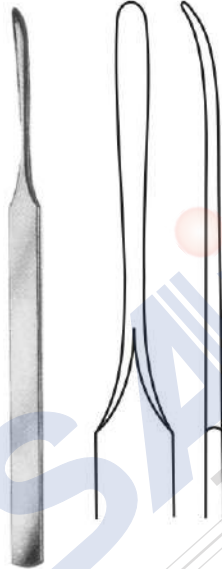

208-0071  
Konig  
15.5cm

4.5mm

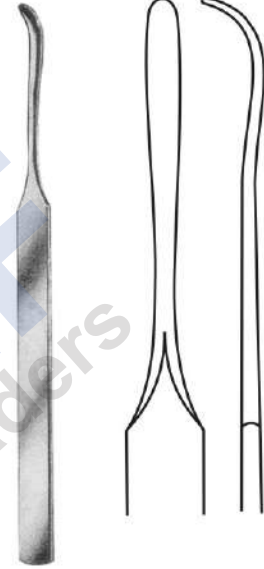

208-0072  
Konig  
15.5cm

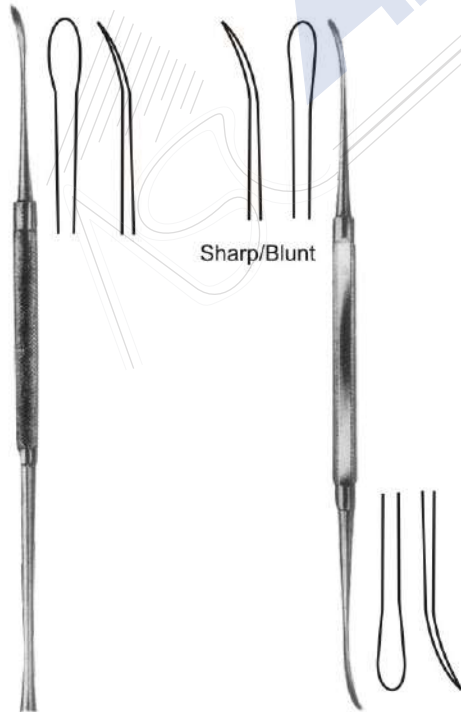

Sharp/Blunt

208-0073  
Freer  
19cm

208-0074  
Freer  
18.5cm



208-0075  
Freer-Yasargil  
18.5cm

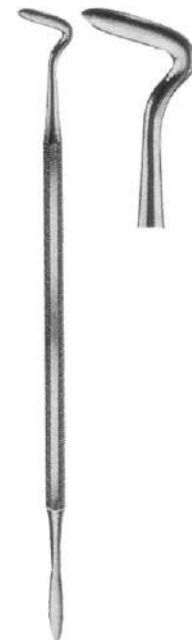

208-0076  
Kendzia  
17cm

## ● ● ● ELEVATORS

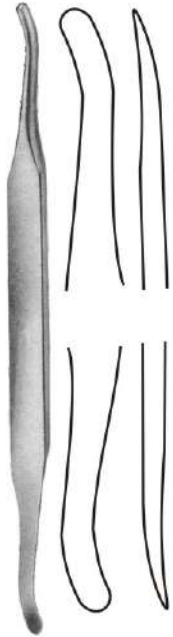

208-0077  
Scladin  
19.5cm

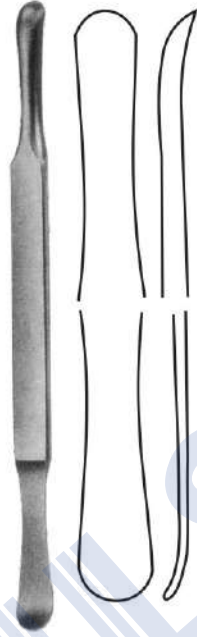

208-0078  
Scladin  
19.5cm



208-0079  
Chompret  
15cm



208-0080



208-0081



208-0082



208-0083



208-0084  
Freer  
16cm



208-0085  
Freer  
16cm



208-0086  
Partsch, mod  
14.5cm

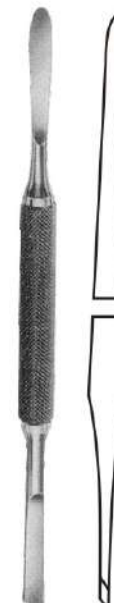

208-0087  
Mead  
16.5cm



208-0088  
Mead  
18cm

## ELEVATORS ●●●



## ●●● CHISELS & GOUGES

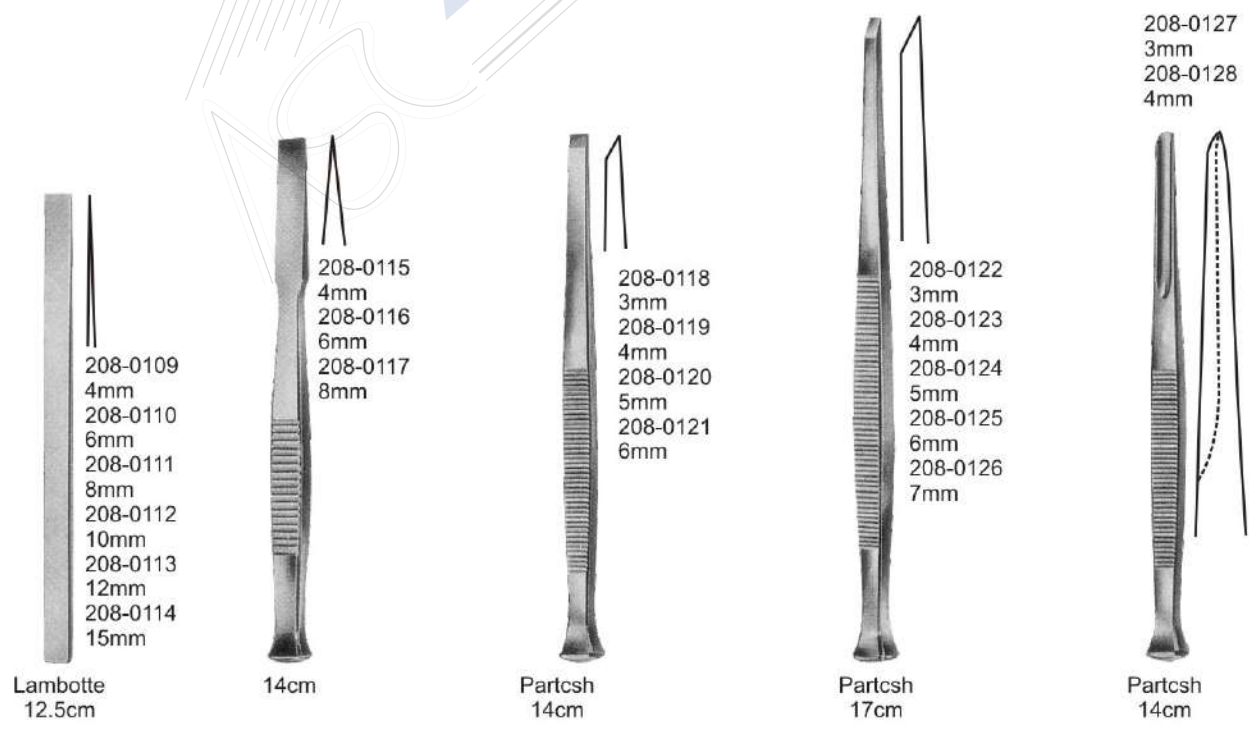



## RUBBER DAM INSTRUMENTS ●●●

Calmp forceps



209-0001  
Ivory light weight  
17cm

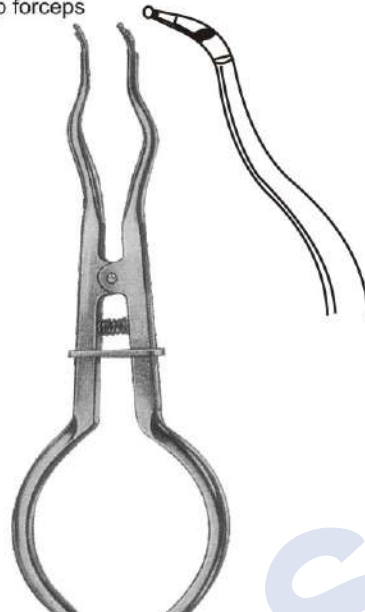

209-0002  
Brewer  
17.5cm

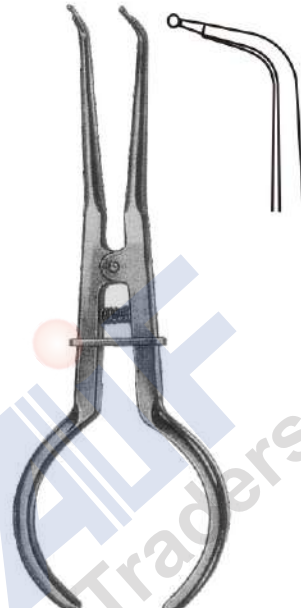

209-0003  
Stokes  
17.5cm

Punch forceps



209-0004  
Ainsworth  
17cm

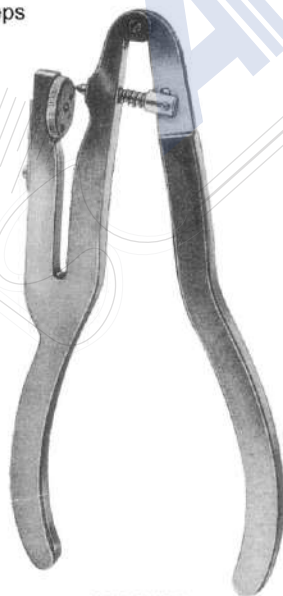

209-0005  
Ivory  
17cm

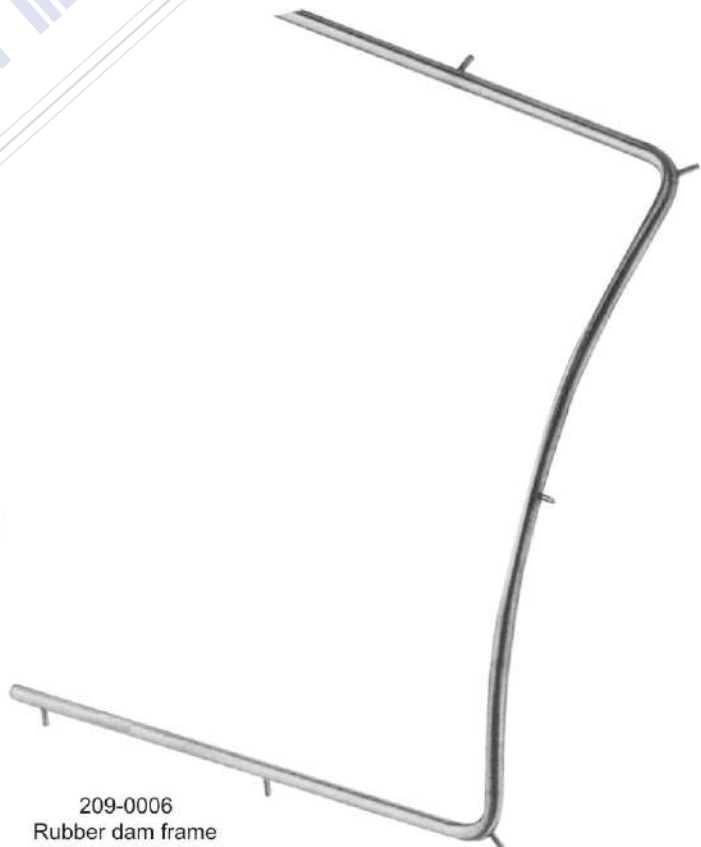

209-0006  
Rubber dam frame

## ●●● TISSUE PLIERS

210-0001  
Adson, 12cm



210-0002  
Adson1x2, 12cm



210-0003  
Fig. 1  
Semken-Taylor  
12.5 cm



210-0004  
Fig. 2  
Semken-Taylor  
12.5cm



210-0005  
Fig. 1  
Semken-Taylor 1x2  
12.5cm



210-0006  
Fig. 2  
Semken-Taylor 1x2  
12.5cm



210-0007  
12cm



210-0008  
11.5cm

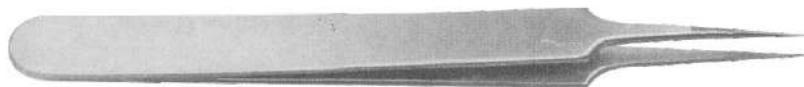

210-0009  
11.5cm



210-0010  
11.5cm



## COTTON AND DRESSING PLIERS ●●●

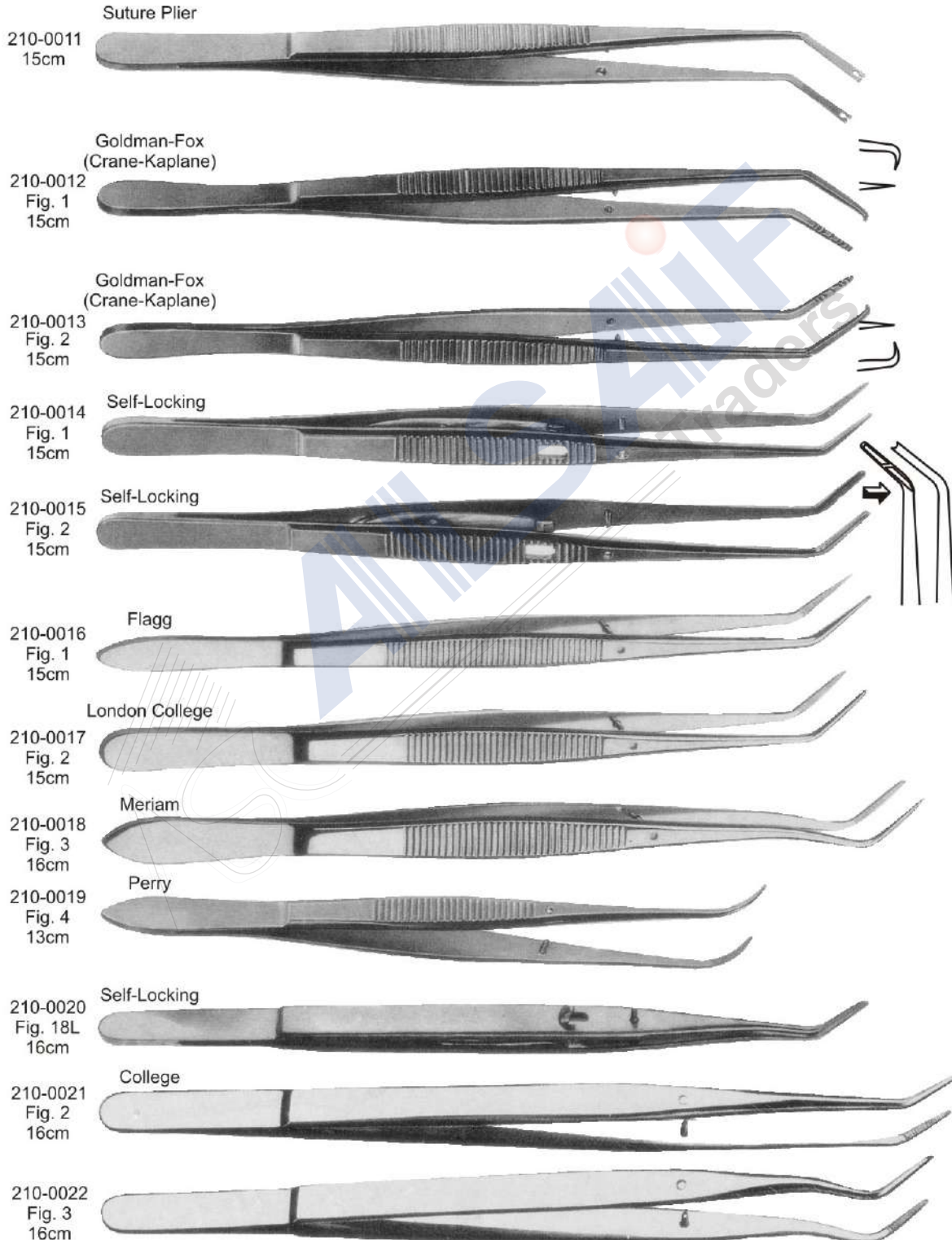

## ●●● SCALPEL HANDLES



211-0001  
No.3L

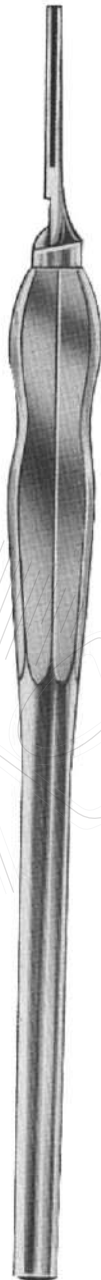

211-0002  
ERGONOMIC



211-0003  
No.7

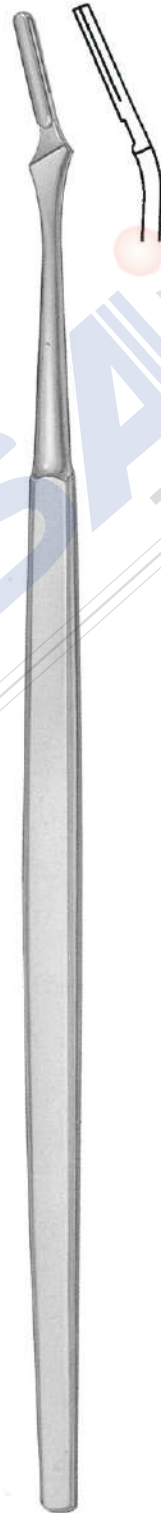

211-0004



211-0005



211-0006



211-0007  
No.4L

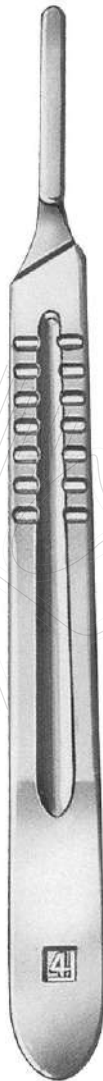

211-0008  
No.4

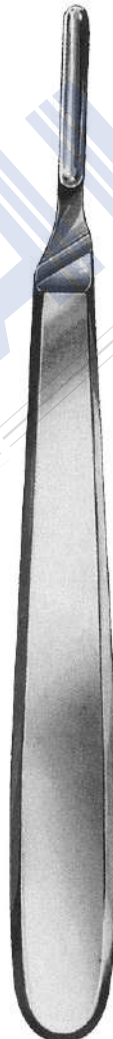

211-0009  
No.10



211-0010  
No.9



211-0011  
No. 3



211-0012  
BARRON  
For "B.P." type blades  
for use with No's  
10,11,12 & 15 blades  
135mm (5.1/4")

## ●●● HANDLES REFERENCE GUIDE



211-0013  
Single ended  
Knurling round



211-0014  
Double ended  
Knurling round

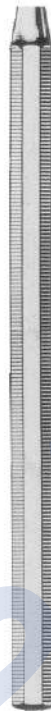

211-0015  
Single ended  
octangle serrated



211-0016  
Double ended  
octangle serrated



211-0017  
Single ended  
hollow round



211-0018  
Double ended  
hollow round



211-0019  
Double ended  
hollow round grooved



211-0020  
Double ended  
swiss pattern octangle

## MICRO, NEEDLE HOLDERS ●●●



212-0001  
CASTROVIEJO  
145mm (5.3/4")  
With catch



212-0002  
CASTROVIEJO  
145mm (5.3/4")  
With catch



212-0003  
ARRUGA  
135mm (5.1/4")



212-0004  
BARRAQUER  
120mm (4.3/4")  
With catch



212-0005  
BARRAQUER  
120mm (4.3/4")  
Without catch



212-0006  
CONVERSE  
125mm (5")

212-0007  
DERF  
120mm (4.3/4")

212-0008  
MAYO (DUNHILL)  
160mm (6.1/4")

212-0009  
MAYO  
180mm (7")

## ●●● NEEDLE HOLDERS



212-0010  
MAYO  
190mm (7.1/2")



212-0011  
CRILE WOOD  
150mm (6")



212-0012  
CRILE MURRAY  
145mm (5.3/4")



212-0013  
KILNER  
135mm (5.1/4")



NAUNTUN MORGAN

212-0014  
190mm (7.1/2")  
212-0015  
250mm (10")



WANGENSTEEN

212-0016  
270mm (10.3/4")



## NEEDLE HOLDERS ●●●

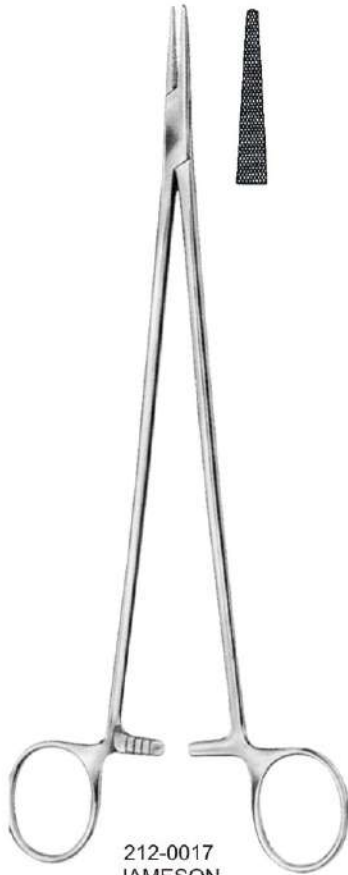

212-0017  
 JAMESON  
 230mm (9")



212-0018  
 WRIGHT  
 125mm (5")

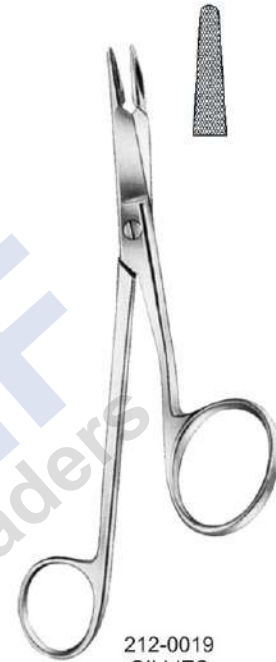

212-0019  
 GILLIES  
 Combined needle holder  
 and scissors  
 160mm (6.1/4")



212-0020  
 WARD  
 Combined needle holder  
 and scissors  
 180mm (7")



212-0021  
 HEANEY  
 200mm (8")

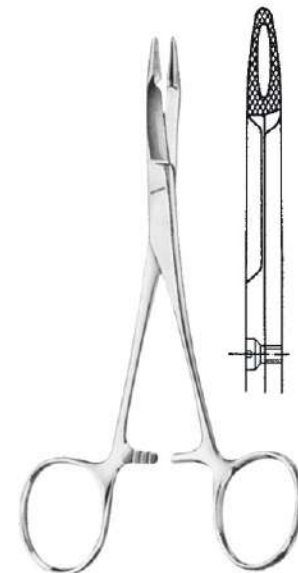

OLSSEN HEGAR  
 Combined needle holder  
 and scissors  
 212-0022 140mm (5.1/2")  
 212-0023 165mm (6.1/2")  
 212-0024 190mm (7.1/2")

## ●●● NEEDLE HOLDERS

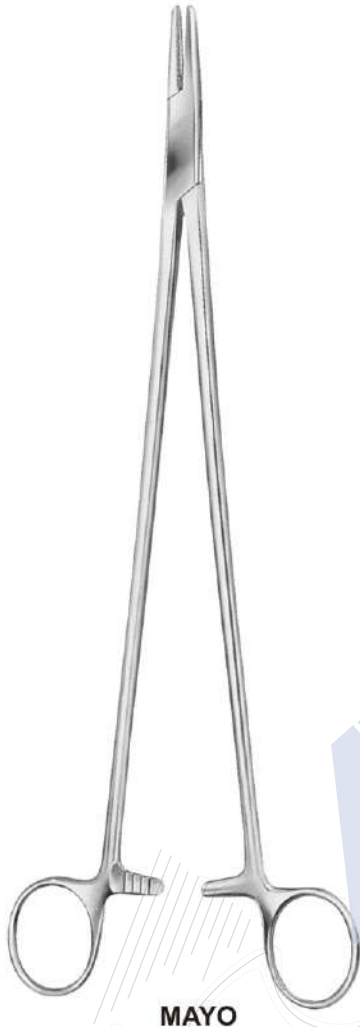

212-0025  
MAYO (BAUMGARTNER)  
140mm (5.1/2")



212-0026  
MAYO (MASSON)  
265mm (10.1/2")



212-0027  
MAYO  
65mm (6.1/2")



212-0028  
190mm (7.1/2")



212-0029  
200mm (8")



212-0030  
230mm (9")



212-0031  
HEGAR  
200mm (8")

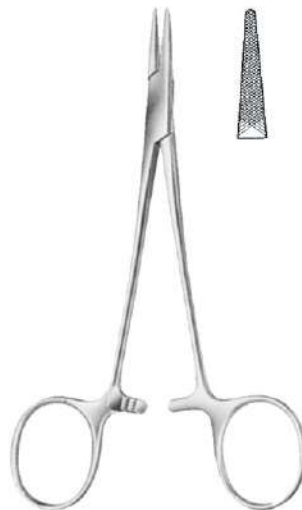

212-0032  
HALSEY  
125mm (5")



212-0033  
MATHIEU  
140mm (5.1/2")

## NEEDLE HOLDERS ●●●



212-0034  
 MATHIEU  
 170mm (6.3/4")



212-0035  
 MATHIEU  
 200mm (8")

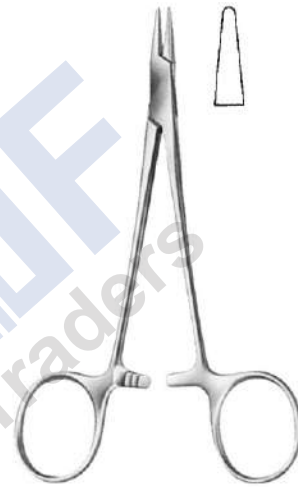

212-0036  
 WEBSTER  
 Smooth Jaw  
 115mm (4.1/2")



212-0037  
 MAYO  
 150mm (6")



212-0038  
 MCPHAILS  
 180mm (7")



LAWRENCE  
 212-0039 150mm (6")  
 Lightweight  
 212-0040 150mm (6")

## ●●● MOUTH MIRRORS



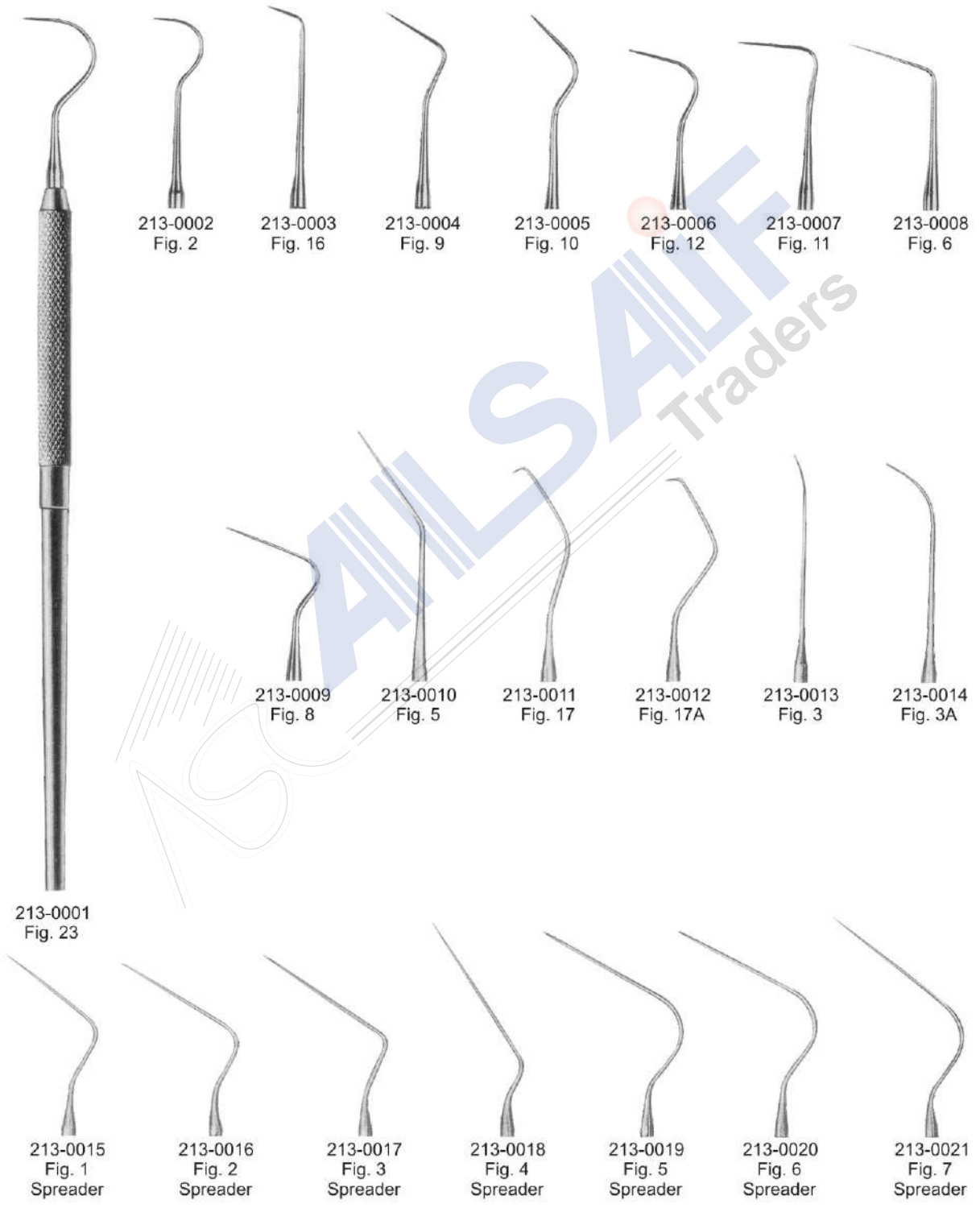

213-0001  
Fig. 23

213-0002  
Fig. 2

213-0003  
Fig. 16

213-0004  
Fig. 9

213-0005  
Fig. 10

213-0006  
Fig. 12

213-0007  
Fig. 11

213-0008  
Fig. 6

213-0009  
Fig. 8

213-0010  
Fig. 5

213-0011  
Fig. 17

213-0012  
Fig. 17A

213-0013  
Fig. 3

213-0014  
Fig. 3A

213-0015  
Fig. 1  
Spreader

213-0016  
Fig. 2  
Spreader

213-0017  
Fig. 3  
Spreader

213-0018  
Fig. 4  
Spreader

213-0019  
Fig. 5  
Spreader

213-0020  
Fig. 6  
Spreader

213-0021  
Fig. 7  
Spreader

## ●●● EXPLORERS PROBES

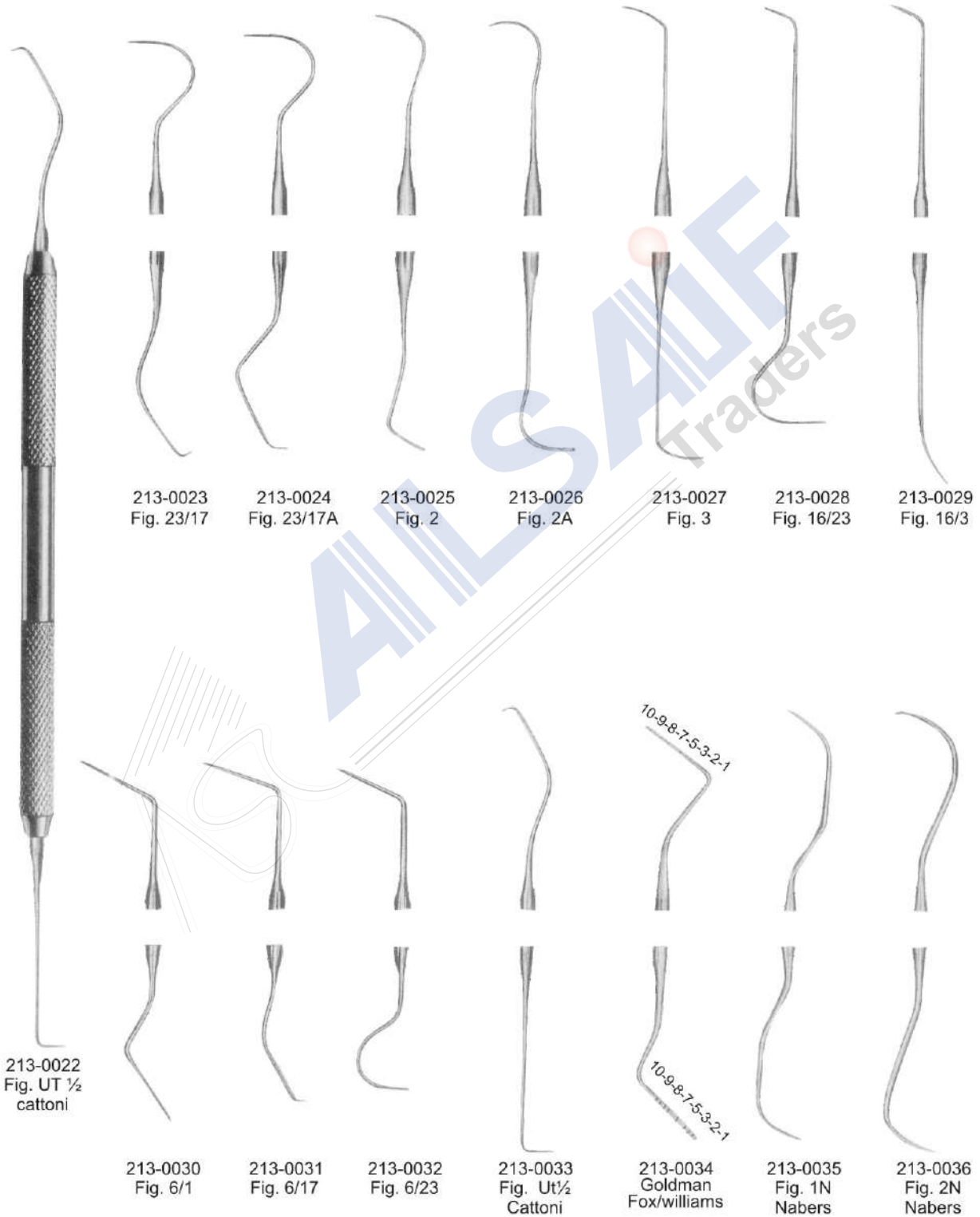

Root canal explorers

## EXPLORERS ENDODONTIC INSTRUMENTS

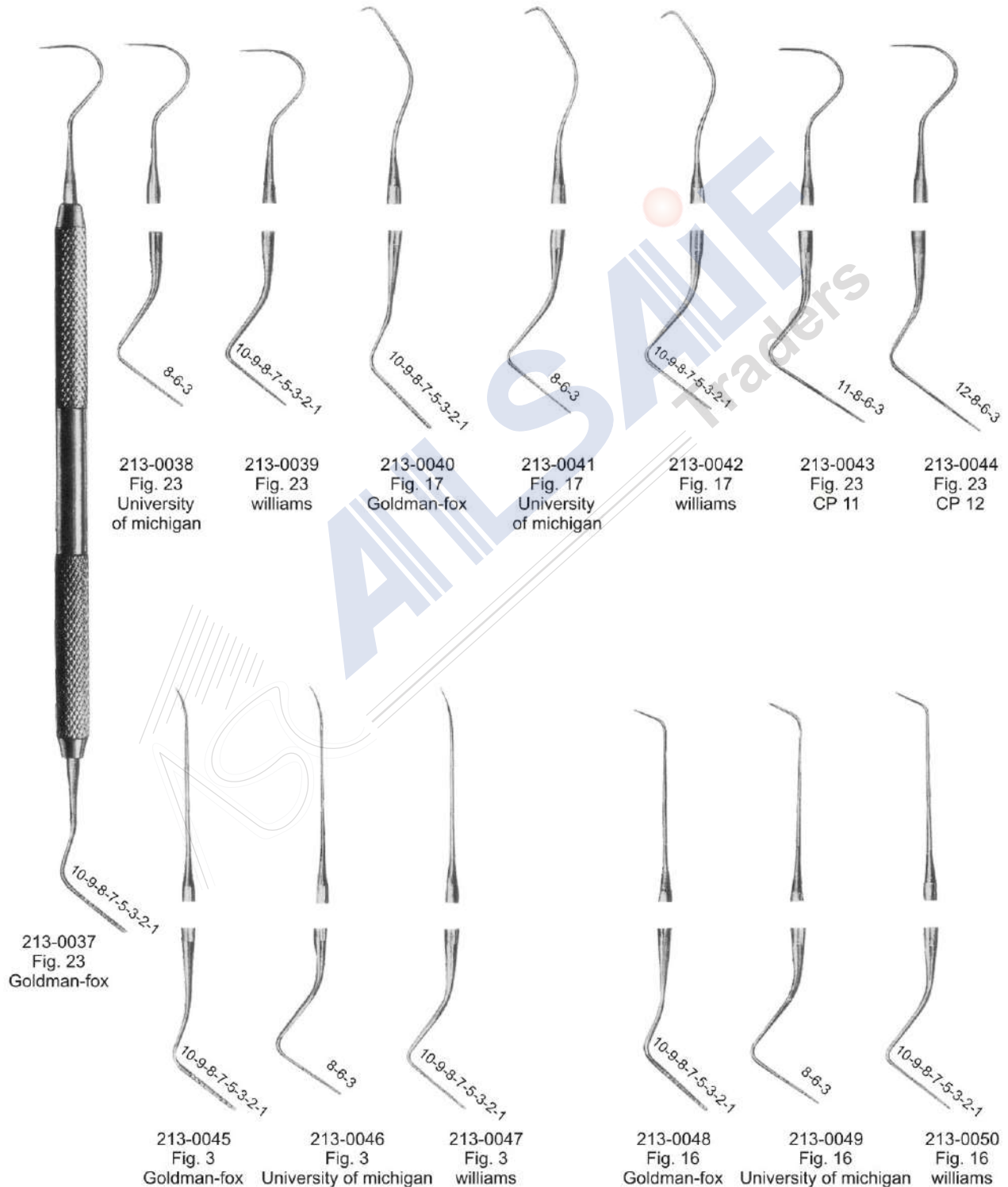

## ●●● PERIODONTAL POCKET PROBES ENDODONTIC INS

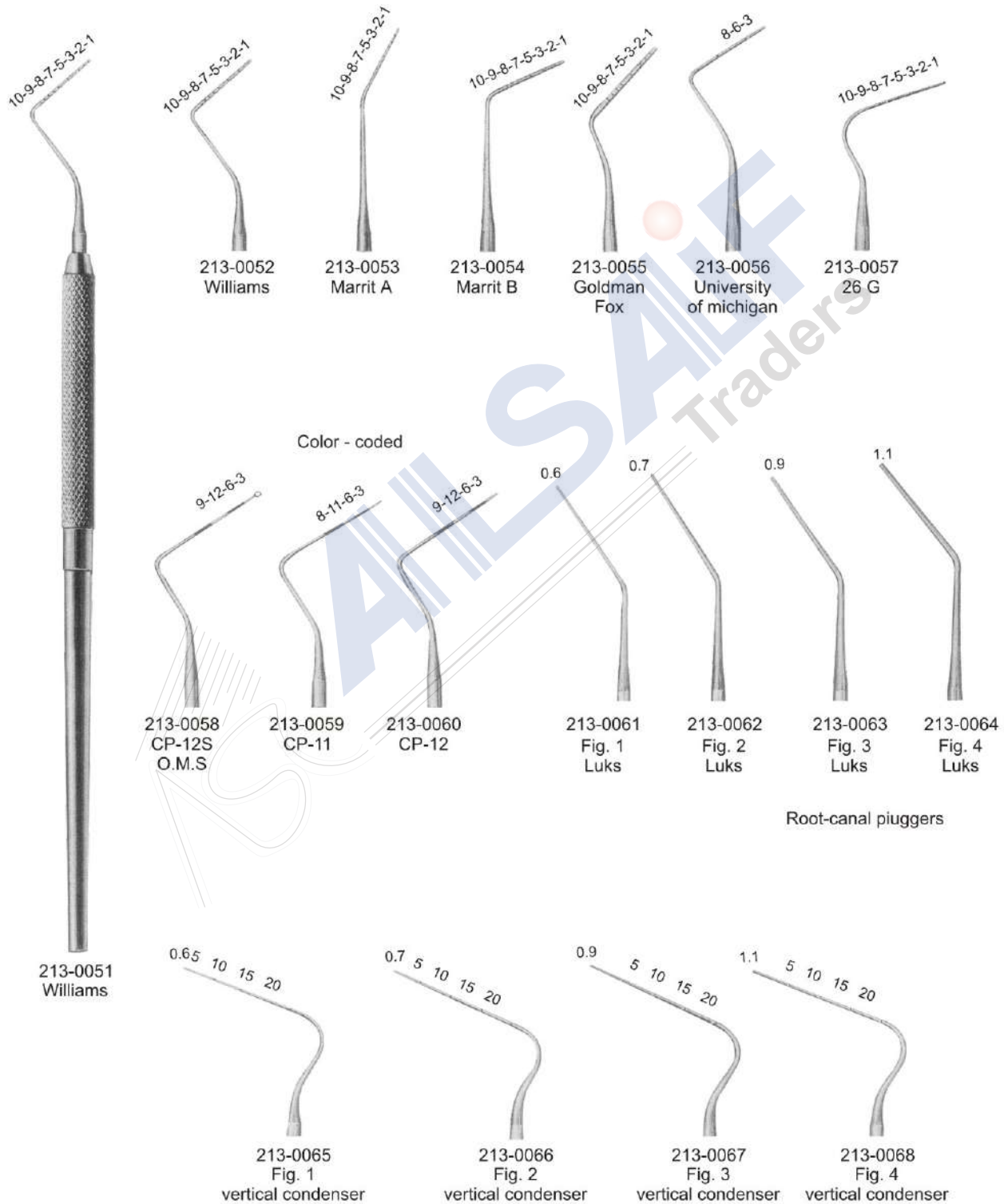



## FILLING INSTRUMENTS ●●●

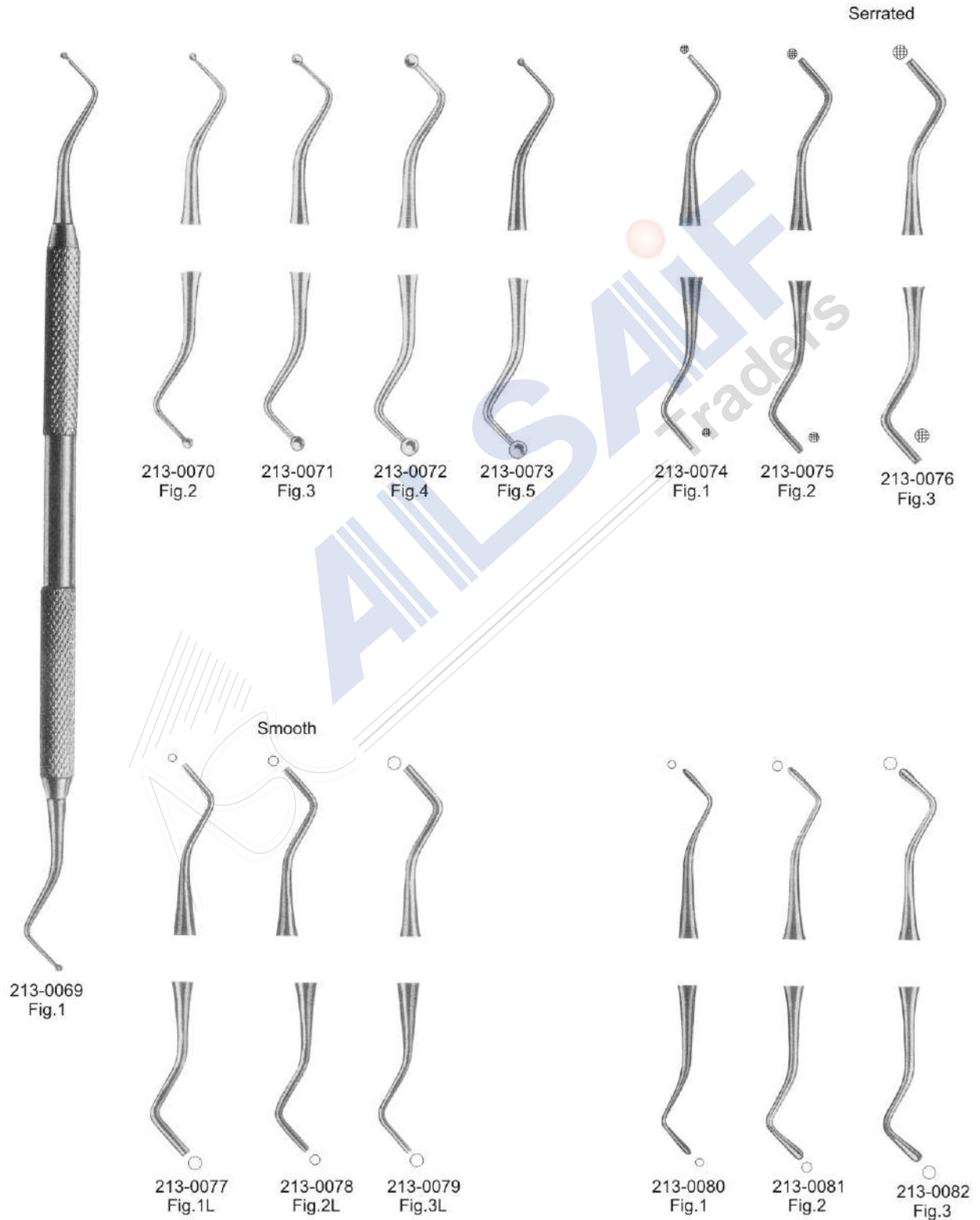

## ●●● FILLING INSTRUMENTS

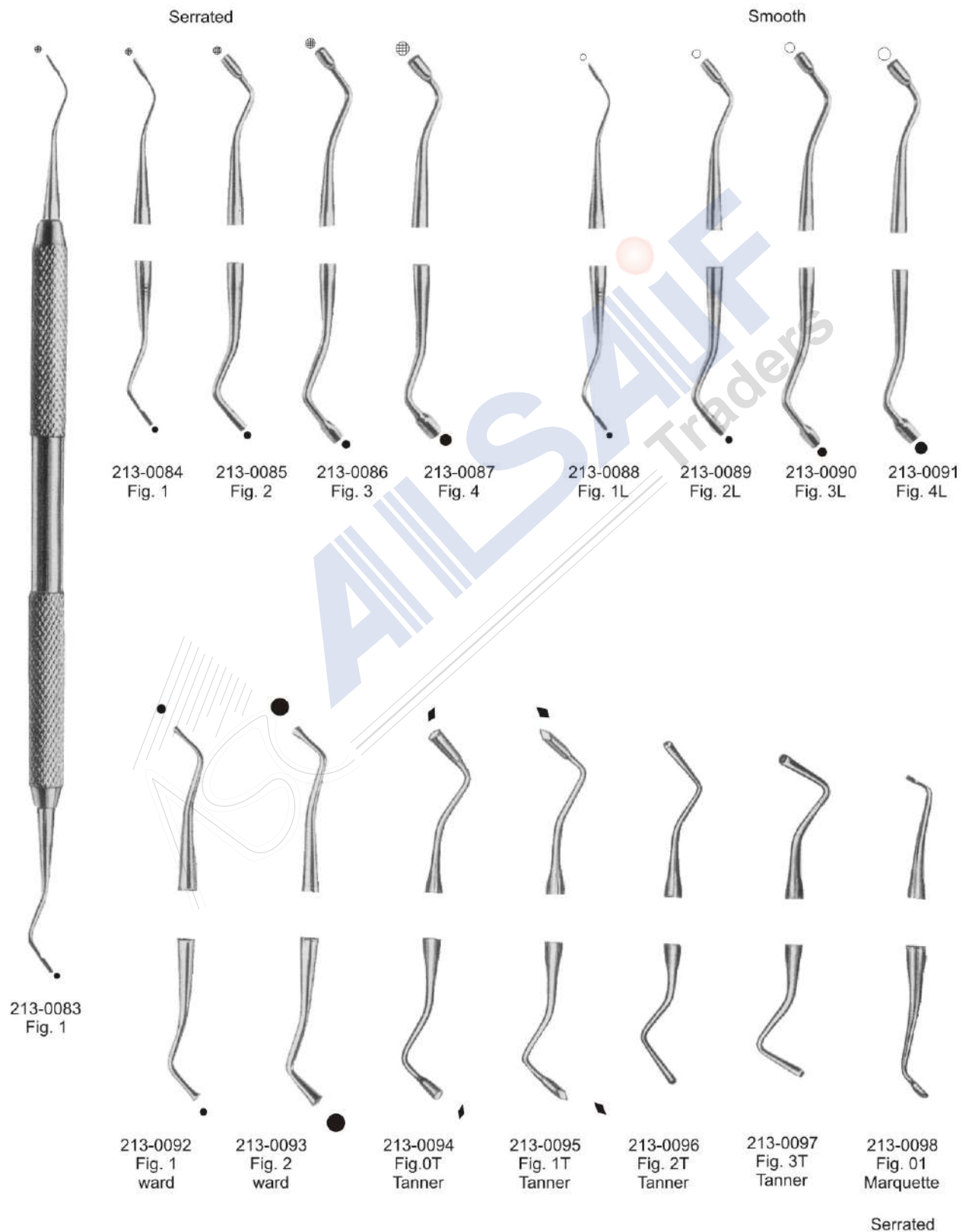

## FILLING INSTRUMENTS ●●●



213-0099  
Fig. 1

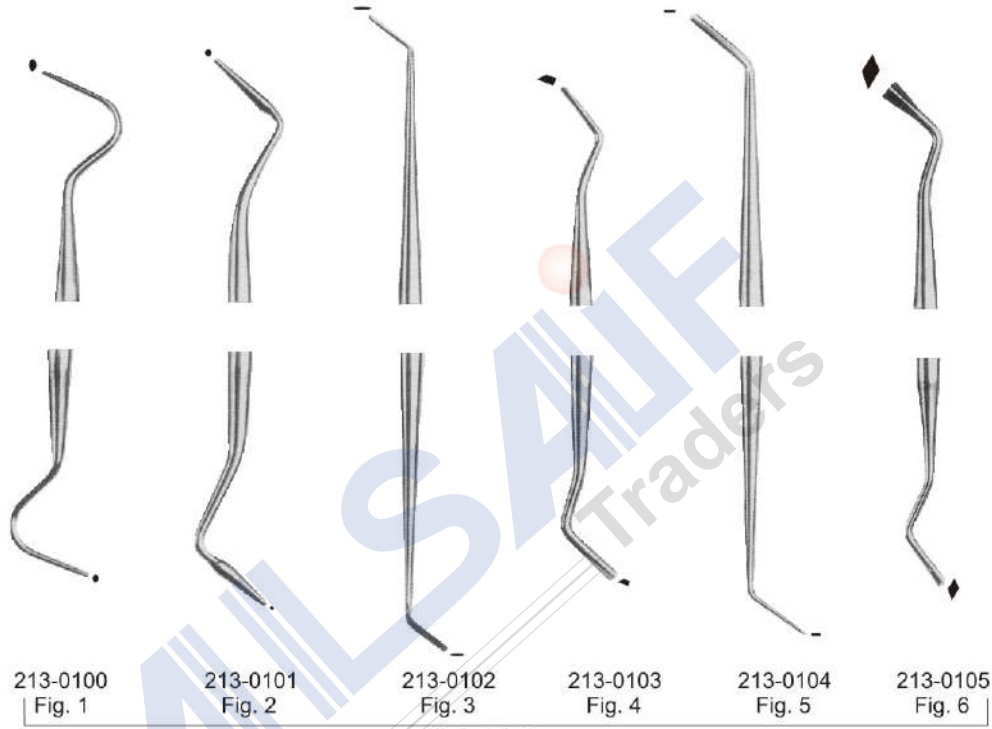

213-0100 Fig. 1      213-0101 Fig. 2      213-0102 Fig. 3      213-0103 Fig. 4      213-0104 Fig. 5      213-0105 Fig. 6

Set of 6 pieces

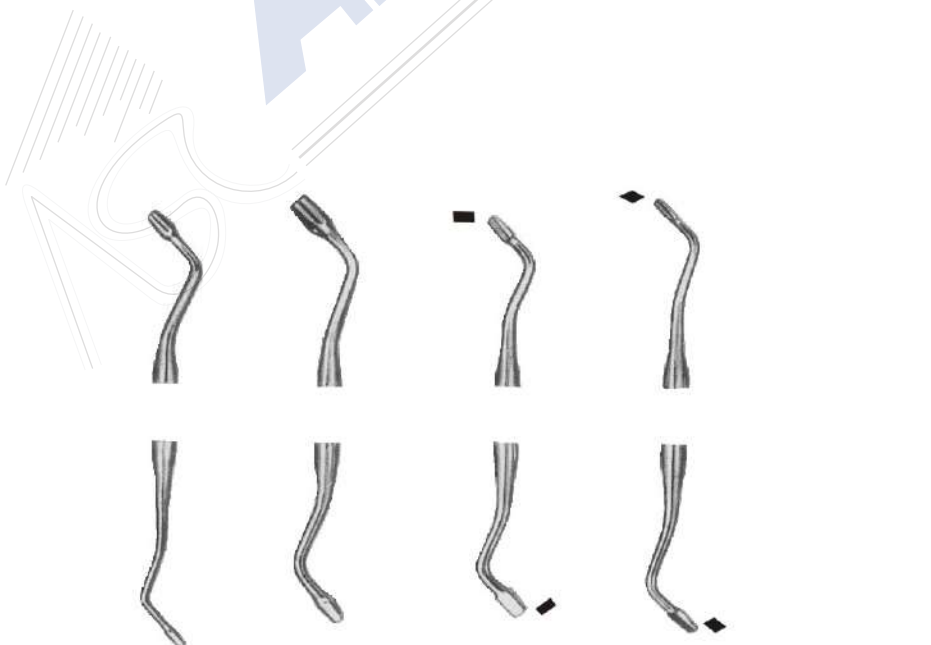

213-0106 Fig. H1 Hollenback      213-0107 Fig. H2 Hollenback      213-0108 Fig. H3 Hollenback      213-0109 Fig. H4 Hollenback

●●● FILLING INSTRUMENTS PLASTIC FILLING INSTRUMENTS



213-0110 Fig. 1 westcott

Plastic Filling Instruments

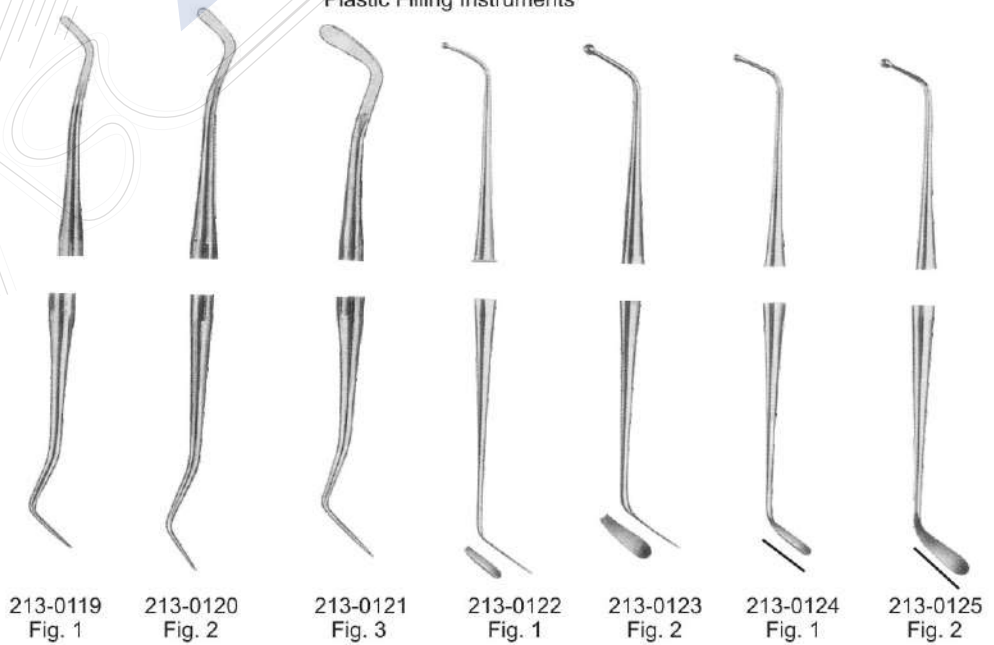

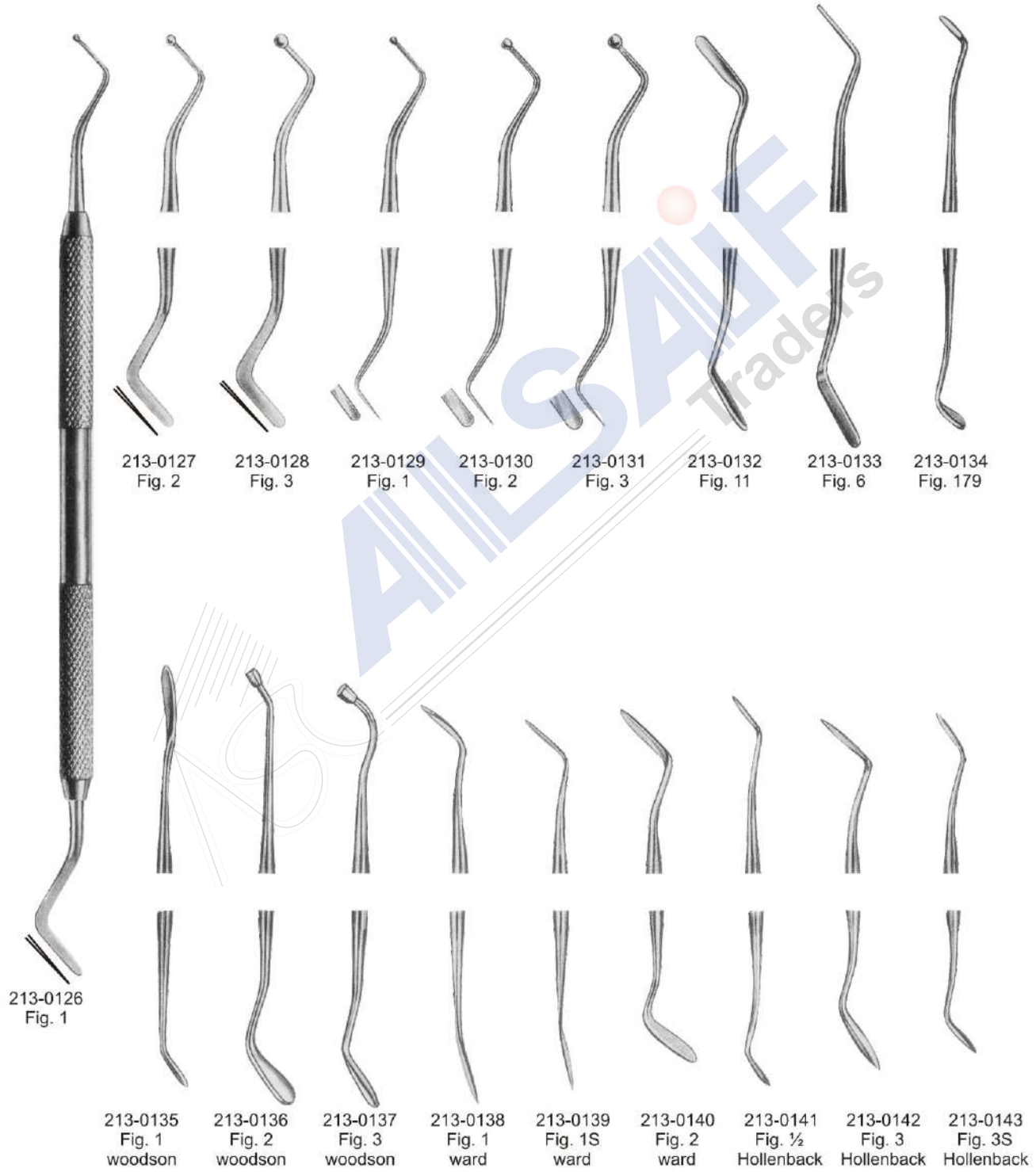

## ●●● AMALGAM CARVERS OPERATIVE INSTRUMENTS

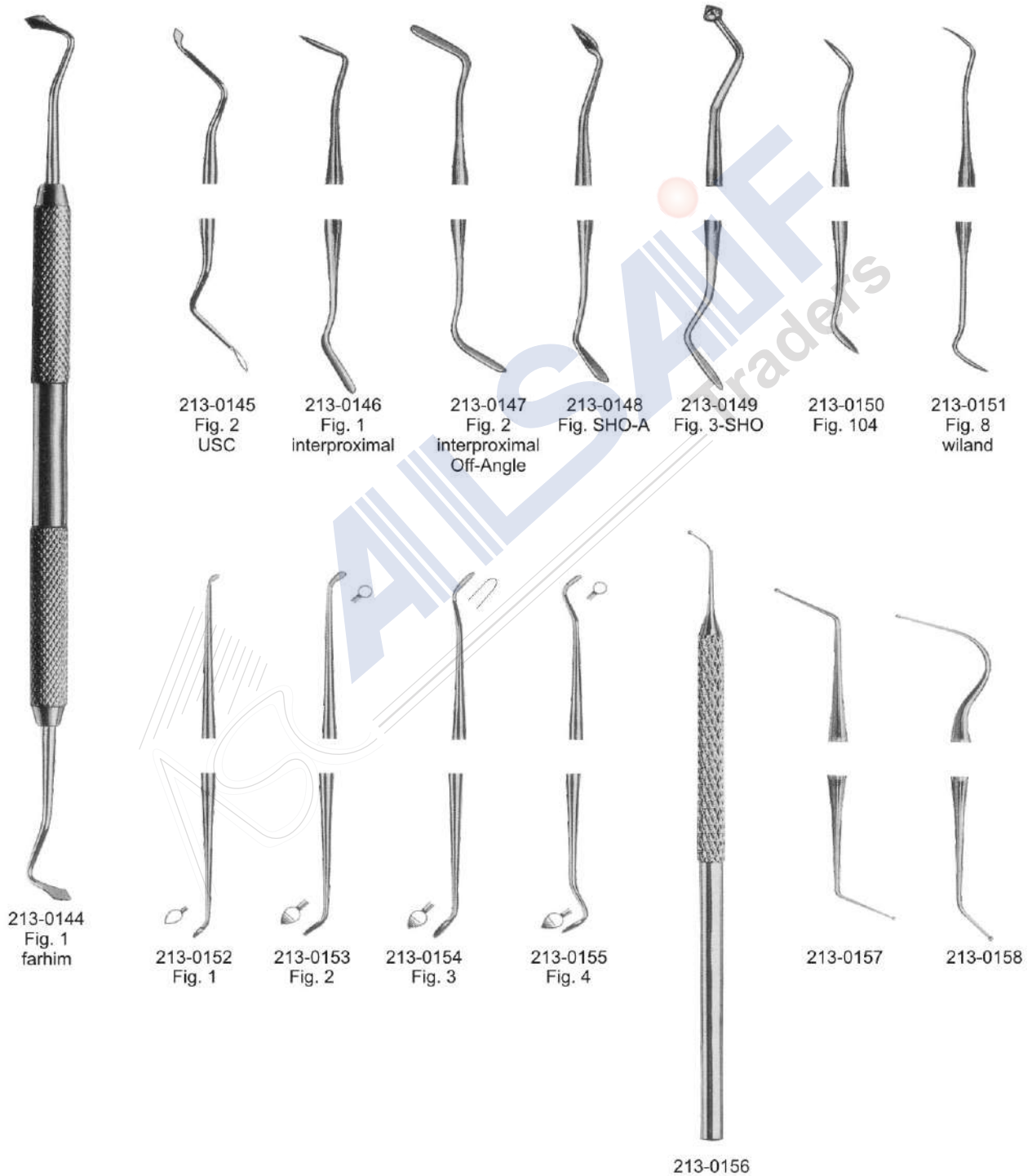

## CAVITY PREPARATION INSTRUMENTS ●●●

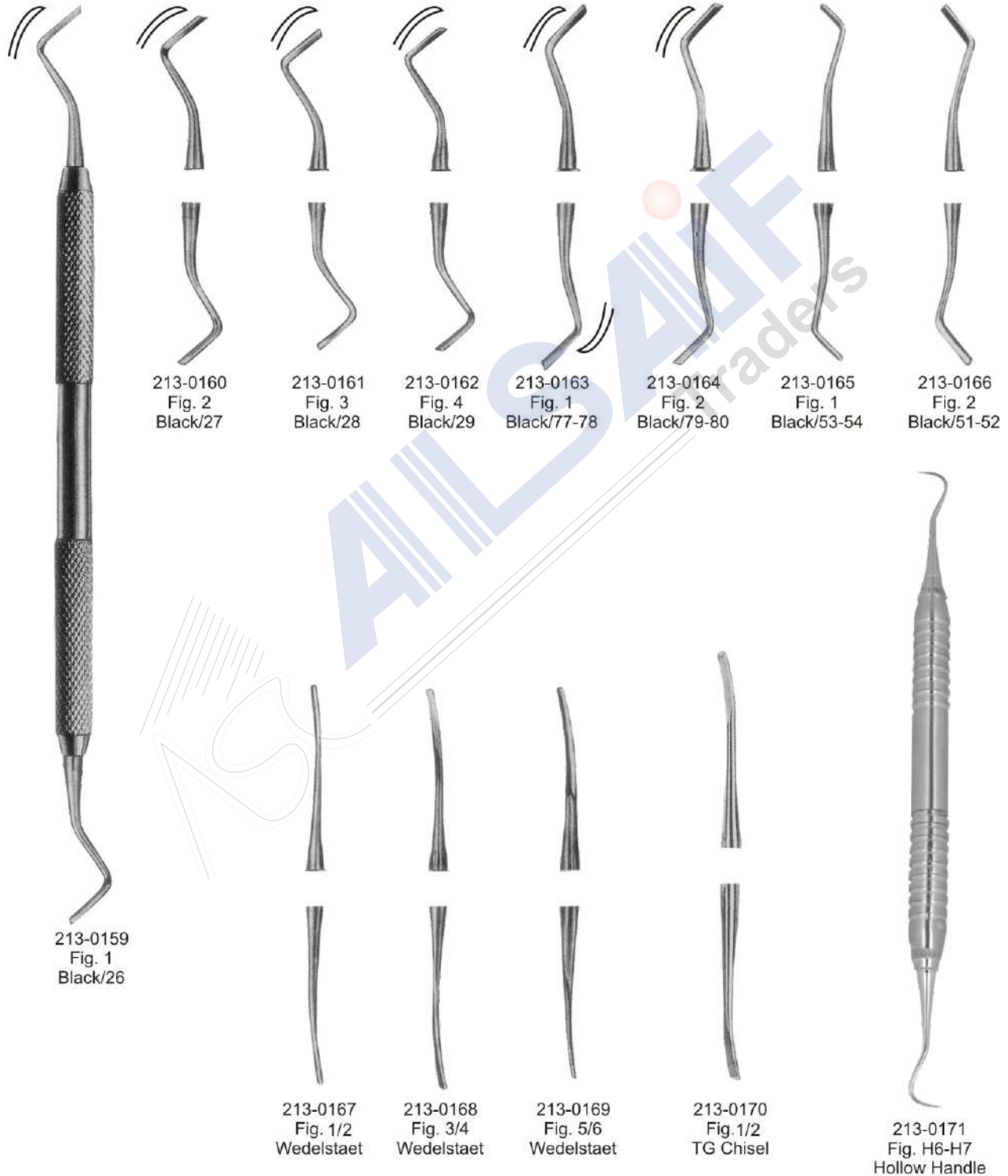

## ●●● EXCAVATORS



213-0172  
Fig. 6



213-0173  
Fig. 14



213-0174  
Fig. 18



213-0175  
Fig. 17W  
Oval Spoon



213-0176  
Fig. 17



213-0177  
Fig. 18W  
Oval Spoon



213-0178  
Fig. 19



213-0179  
Fig. 19W  
Oval Spoon

Set of 5 Pieces



213-0180  
Fig. 0



213-0181  
Fig. 1



213-0182  
Fig. 2



213-0183  
Fig. 3



213-0184  
Fig. 4



213-0185  
Fig. 1



213-0186  
Fig. 2



## EXCAVATORS ●●●

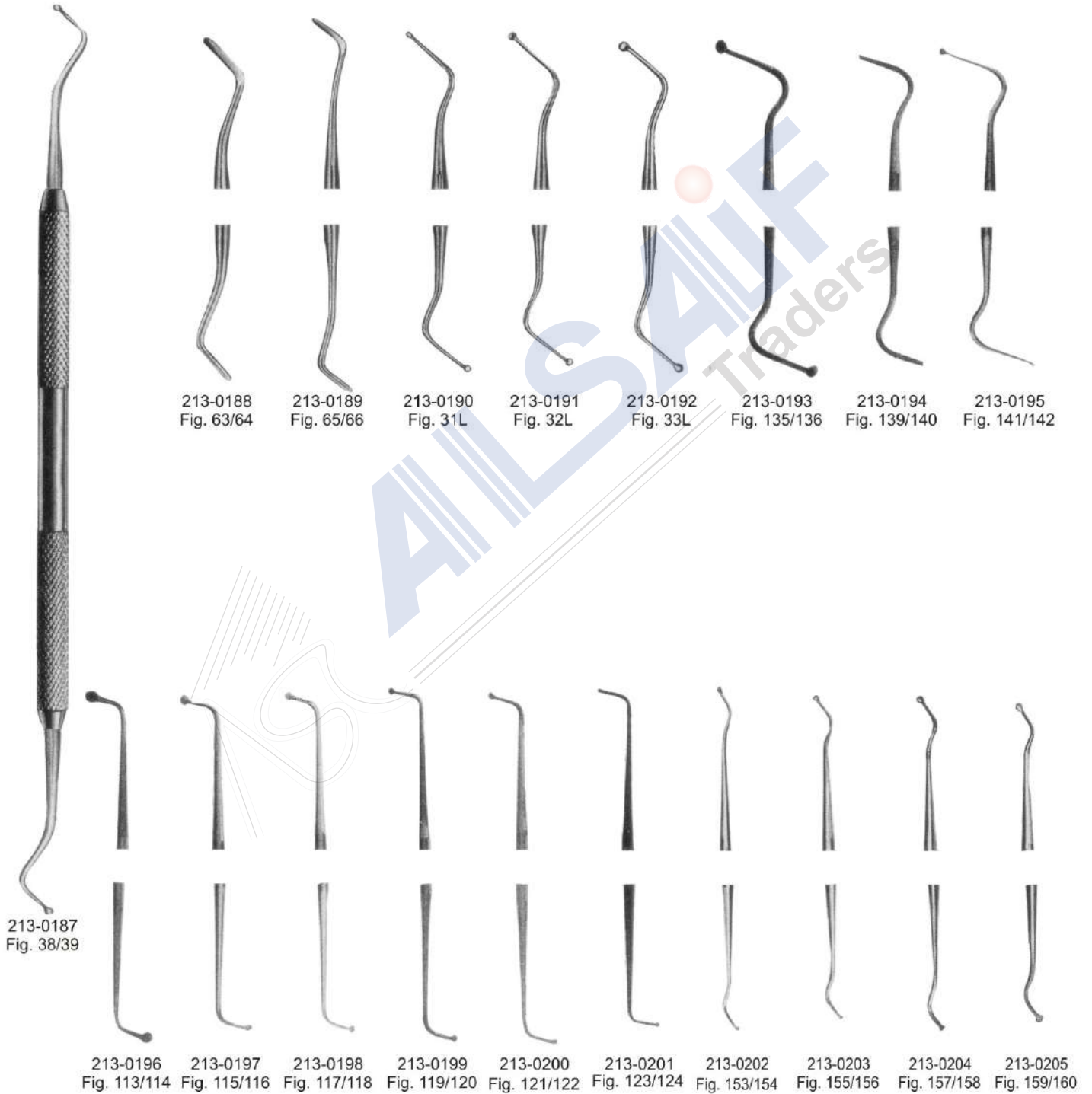

● ● ● EXCAVATORS ENGLISH PATTERN

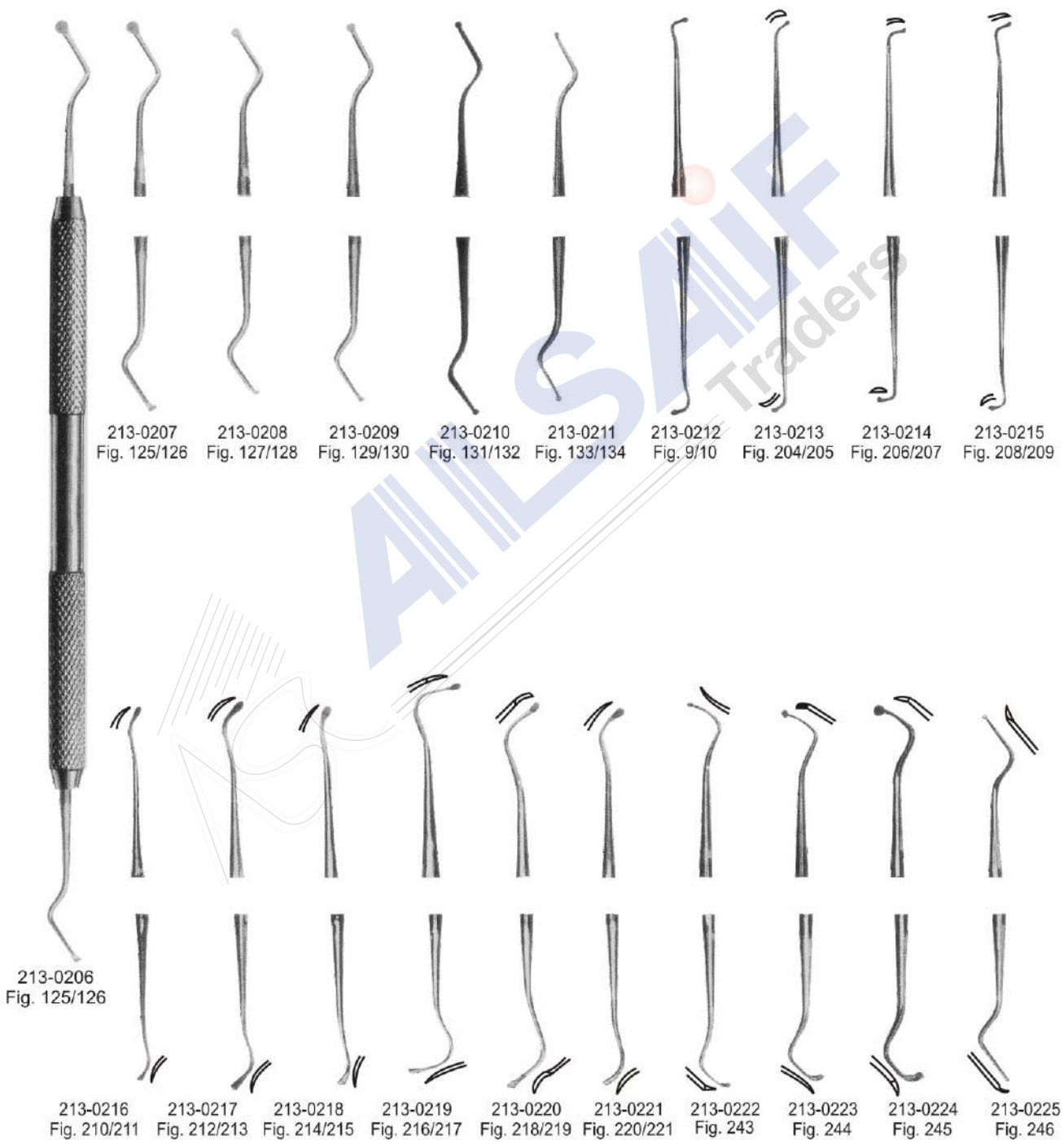



213-0226  
Fig. M9  
Molt

213-0227  
Fig. 1  
Hopkins

213-0228  
Fig. 2  
Hopkins

213-0229  
Fig. 3  
Mead

213-0230  
Fig. 3  
Prichard

213-0231  
Fig. Pr3  
Freer

213-0232  
Fig. 16  
Freer

● ● ● BONE FILES

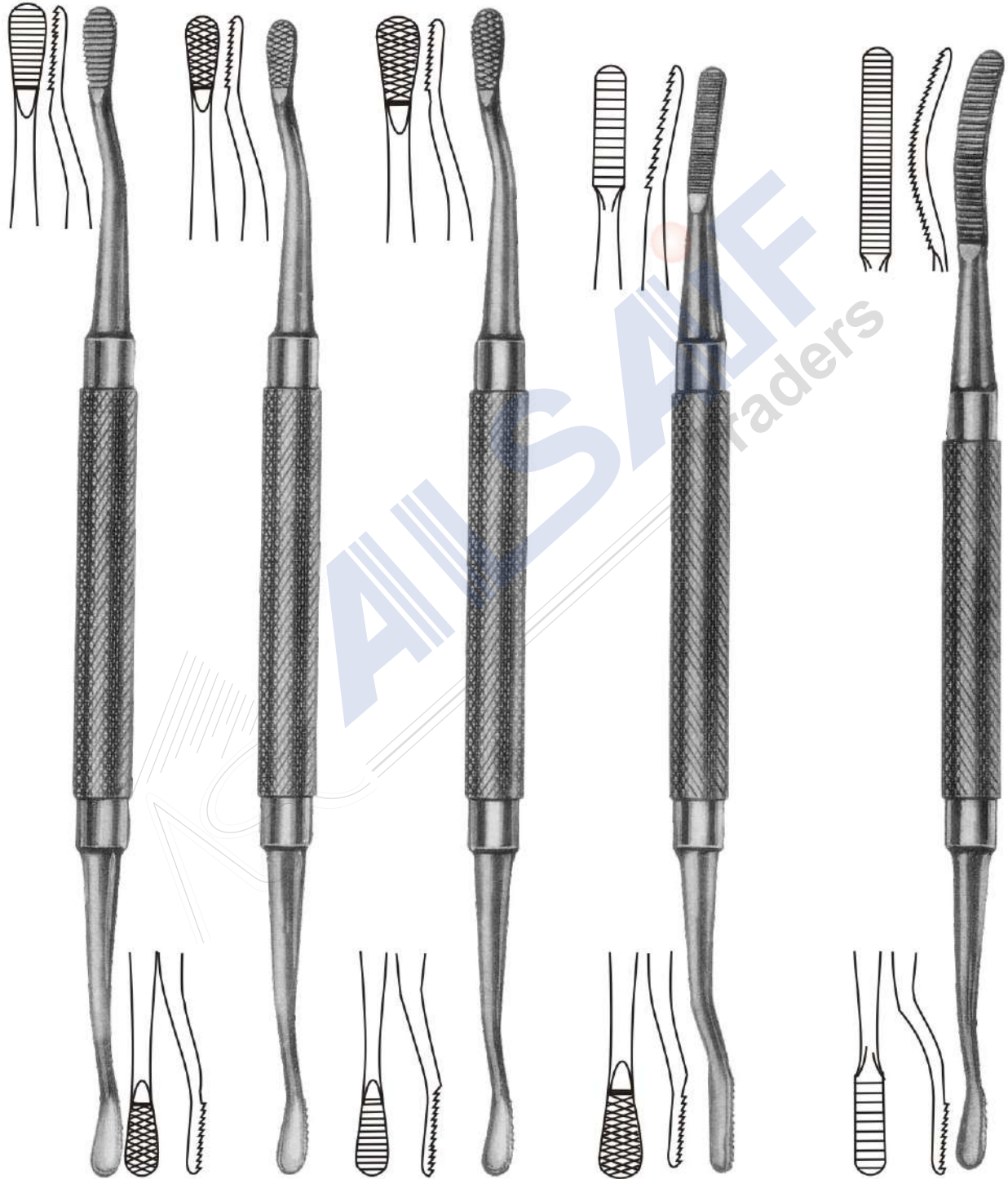

213-0233  
Fig. 12 CA

213-0234  
Fig. 12A

213-0235  
Fig. 12  
Howard

213-0236  
Fig. 33

213-0237  
Fig. 45  
Miller



213-0238  
Fig. 1  
Wahl

213-0239  
Fig. 2  
Wahl

213-0240  
Fig. 1  
Polckoff

213-0241  
Fig. 64  
Miller

213-0242  
Fig. 10

## ●●● BONE CURETTES PERIODONTIA INSTRUMENTS

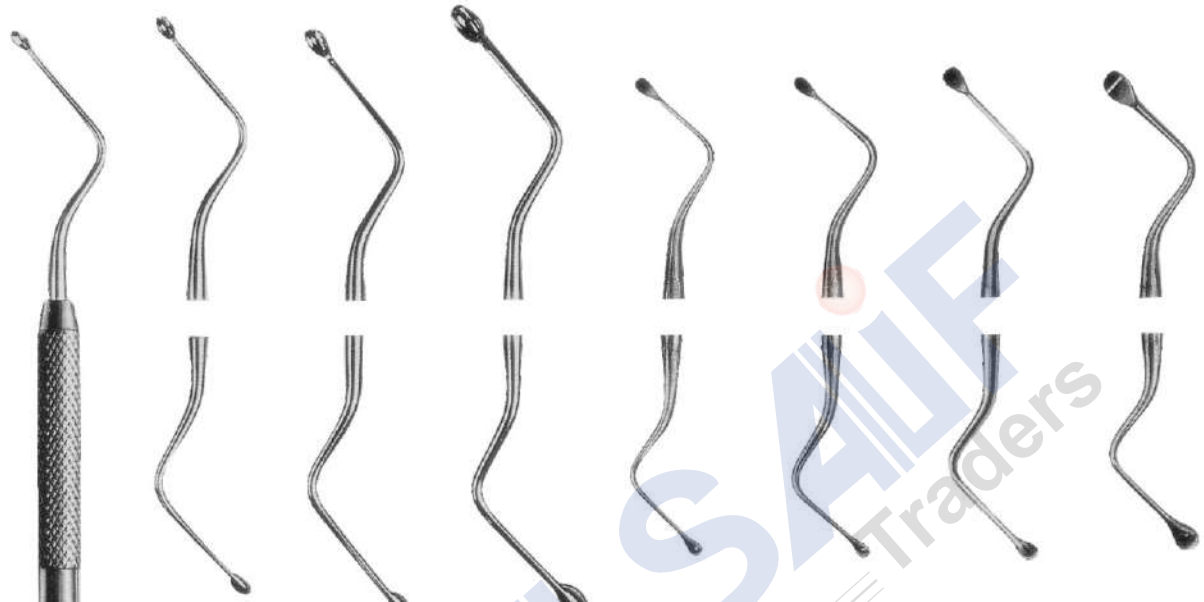

213-0244  
Fig. 2  
Hemingway

213-0245  
Fig. 3  
Hemingway

213-0246  
Fig. 4  
Hemingway

213-0247  
Fig. 85  
Lucas

213-0248  
Fig. 86  
Lucas

213-0249  
Fig. 87  
Lucas

213-0250  
Fig. 88  
Lucas

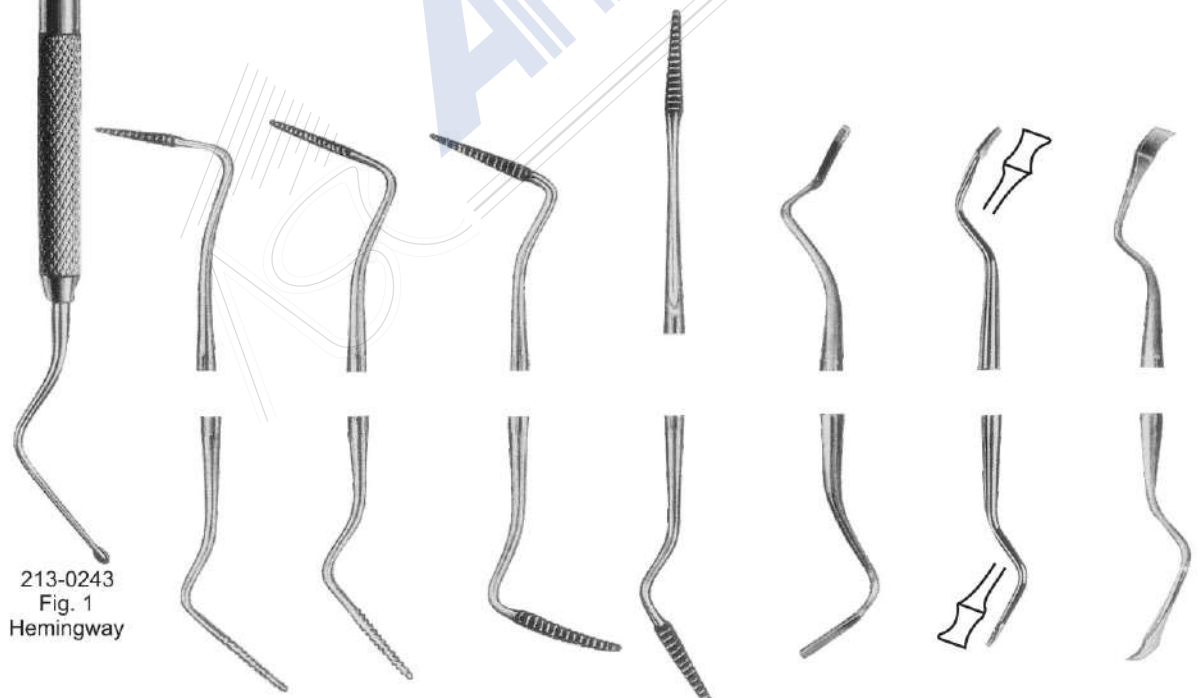

213-0243  
Fig. 1  
Hemingway

213-0251  
Fig. 1S/2S  
Sugarman

213-0252  
Fig. 3S/4S  
Sugarman

213-0253  
Fig. 9/10  
Schluger

213-0254  
Fig. 11/12  
Buck

213-0255  
Fig. 3  
Ochsenbein

213-0256  
Fig. 4  
Ochsenbein

213-0257  
Fig. 36/37  
Rhodes back-action

## PERIODONTIA INSTRUMENTS ●●●



213-0258  
Fig. 7  
Goldman-fox

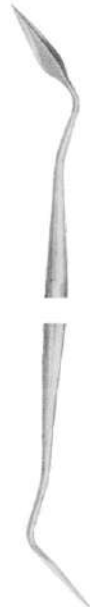

213-0259  
Fig. 8  
Goldman-fox



213-0260  
Fig. 9  
Goldman-fox



213-0261  
Fig. 11  
Goldman-fox

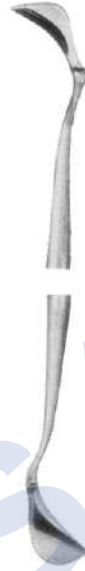

213-0262  
Fig. 3/4  
Buck



213-0263  
Fig. 5/6  
Buck



213-0264  
Fig. 1/2  
(15k16k)  
Kirkland

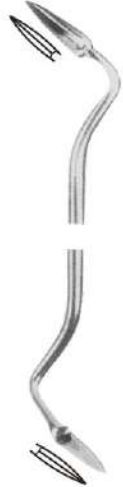

213-0265  
Fig. 1/2  
Orabin

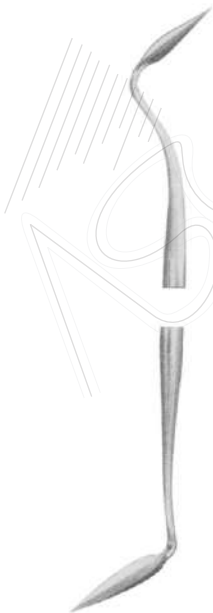

213-0266  
Fig. 1/2  
Sanders



213-0267  
Fig. 4/5  
Sanders



213-0268  
Fig. 19/20  
Sanders  
(University of South California)  
USC Towner

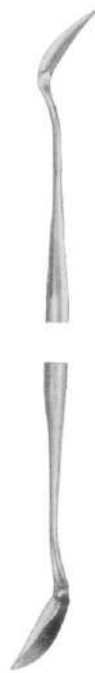

213-0269  
Fig. Ck3  
crane-kaplan

## ●●● PERIODONTIA INSTRUMENTS

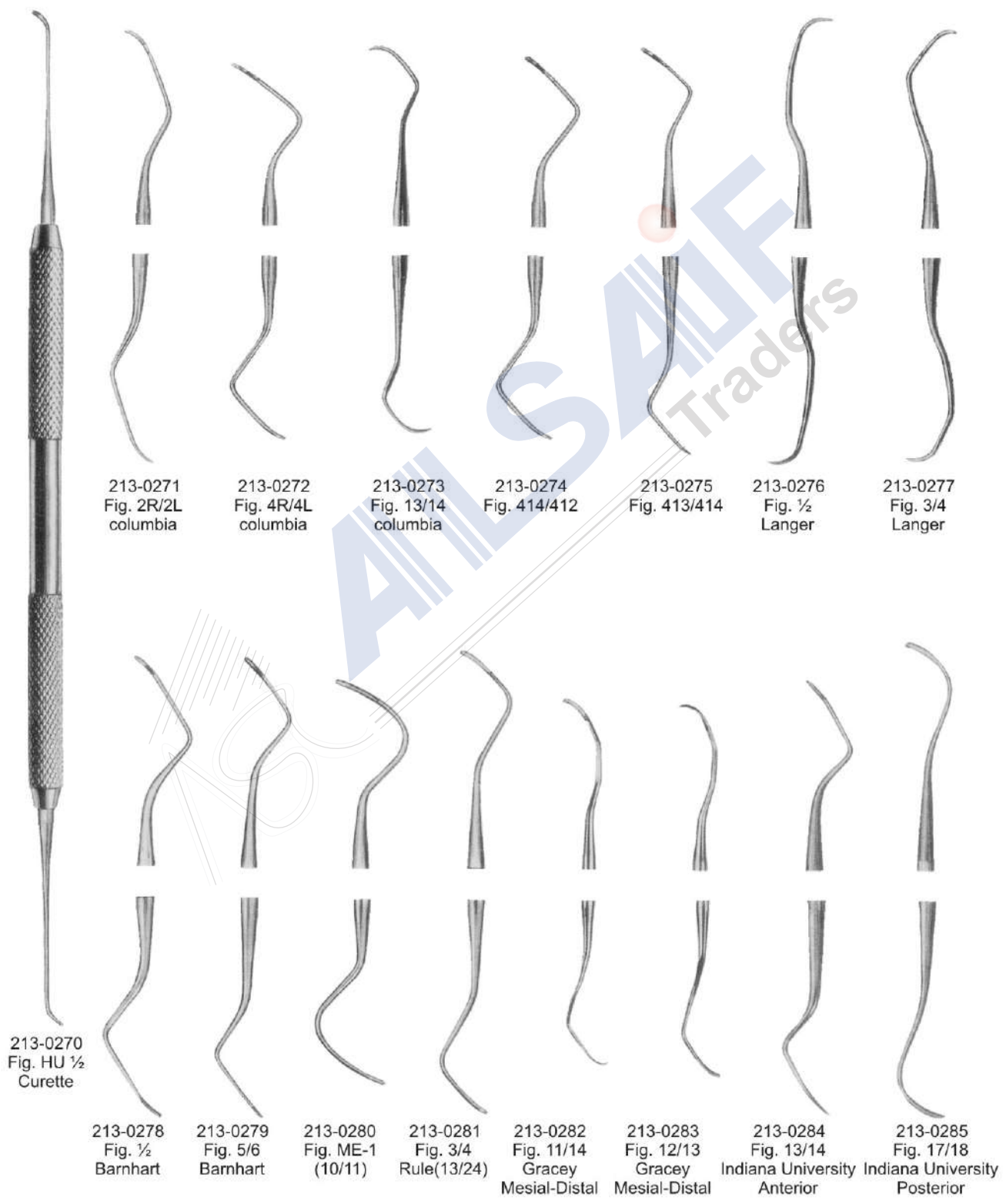

213-0271  
Fig. 2R/2L  
columbia

213-0272  
Fig. 4R/4L  
columbia

213-0273  
Fig. 13/14  
columbia

213-0274  
Fig. 414/412

213-0275  
Fig. 413/414

213-0276  
Fig. 1/2  
Langer

213-0277  
Fig. 3/4  
Langer

213-0270  
Fig. HU 1/2  
Curette

213-0278  
Fig. 1/2  
Barnhart

213-0279  
Fig. 5/6  
Barnhart

213-0280  
Fig. ME-1  
(10/11)

213-0281  
Fig. 3/4  
Rule(13/24)

213-0282  
Fig. 11/14  
Gracey  
Mesial-Distal

213-0283  
Fig. 12/13  
Gracey  
Mesial-Distal

213-0284  
Fig. 13/14  
Indiana University  
Anterior

213-0285  
Fig. 17/18  
Indiana University  
Posterior



## PERIODONTIA INSTRUMENTS GRACEY CURETTES ● ● ●

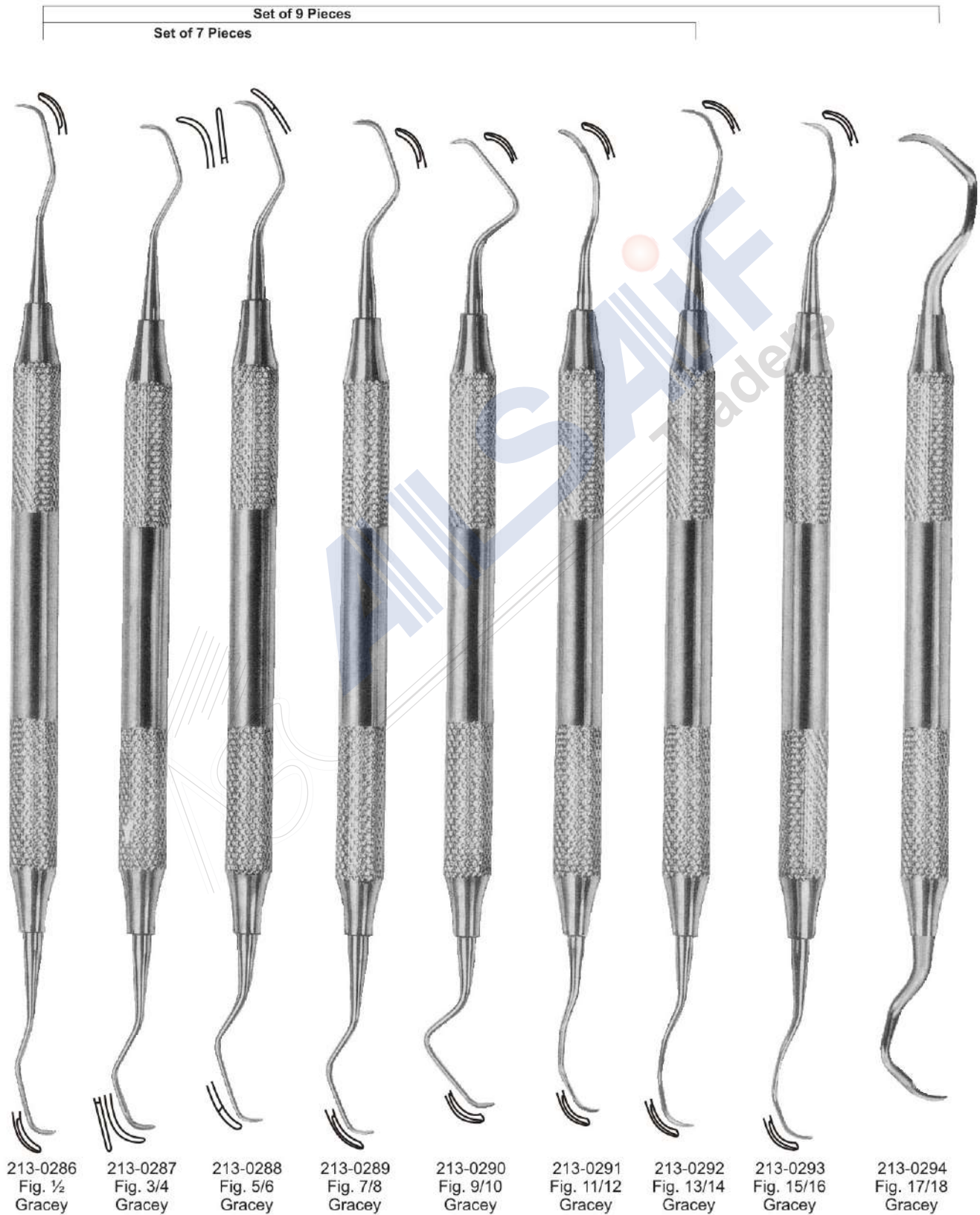

## ●●● PERIODONTIA INSTRUMENTS

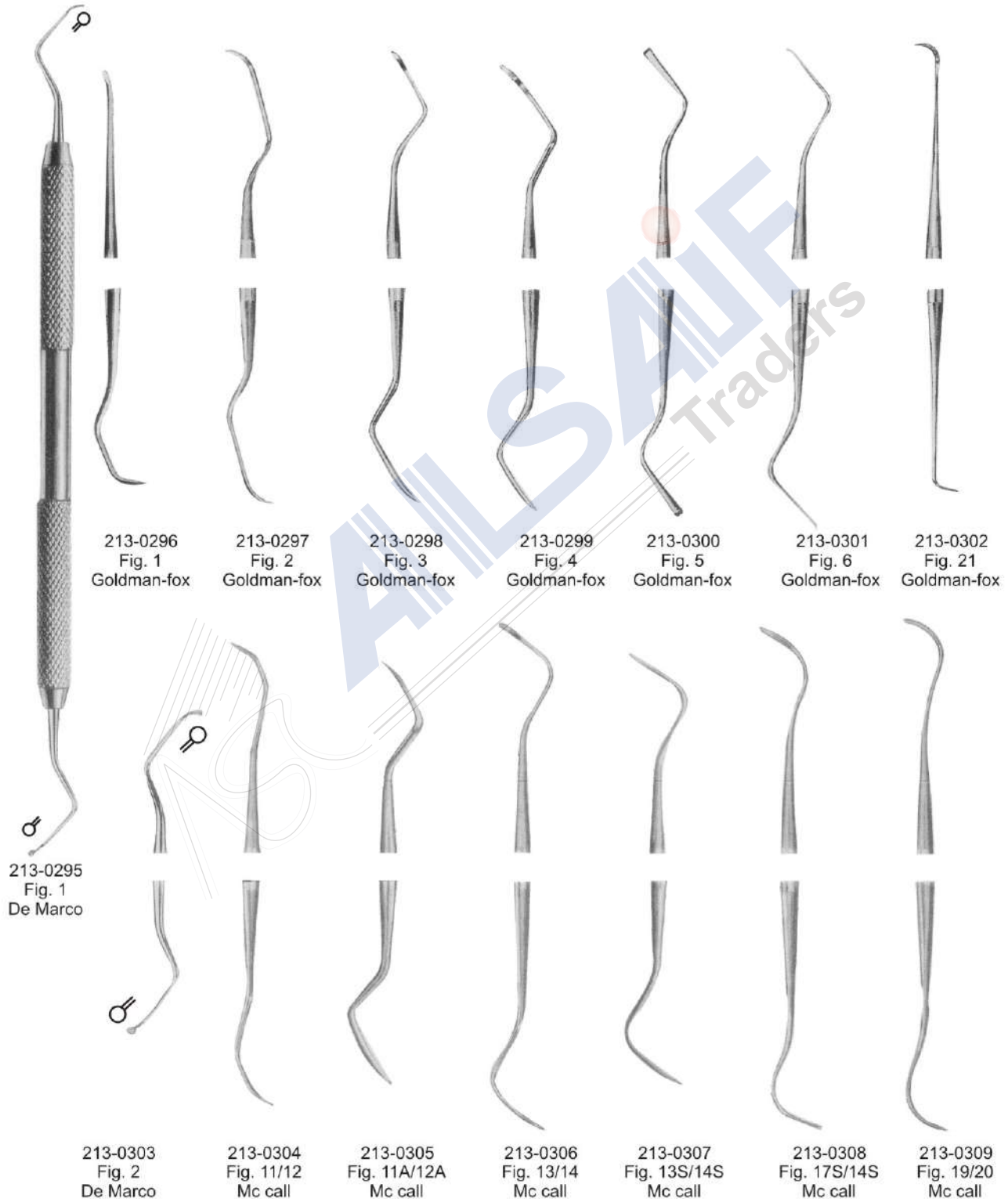

## PERIODONTIA INSTRUMENTS

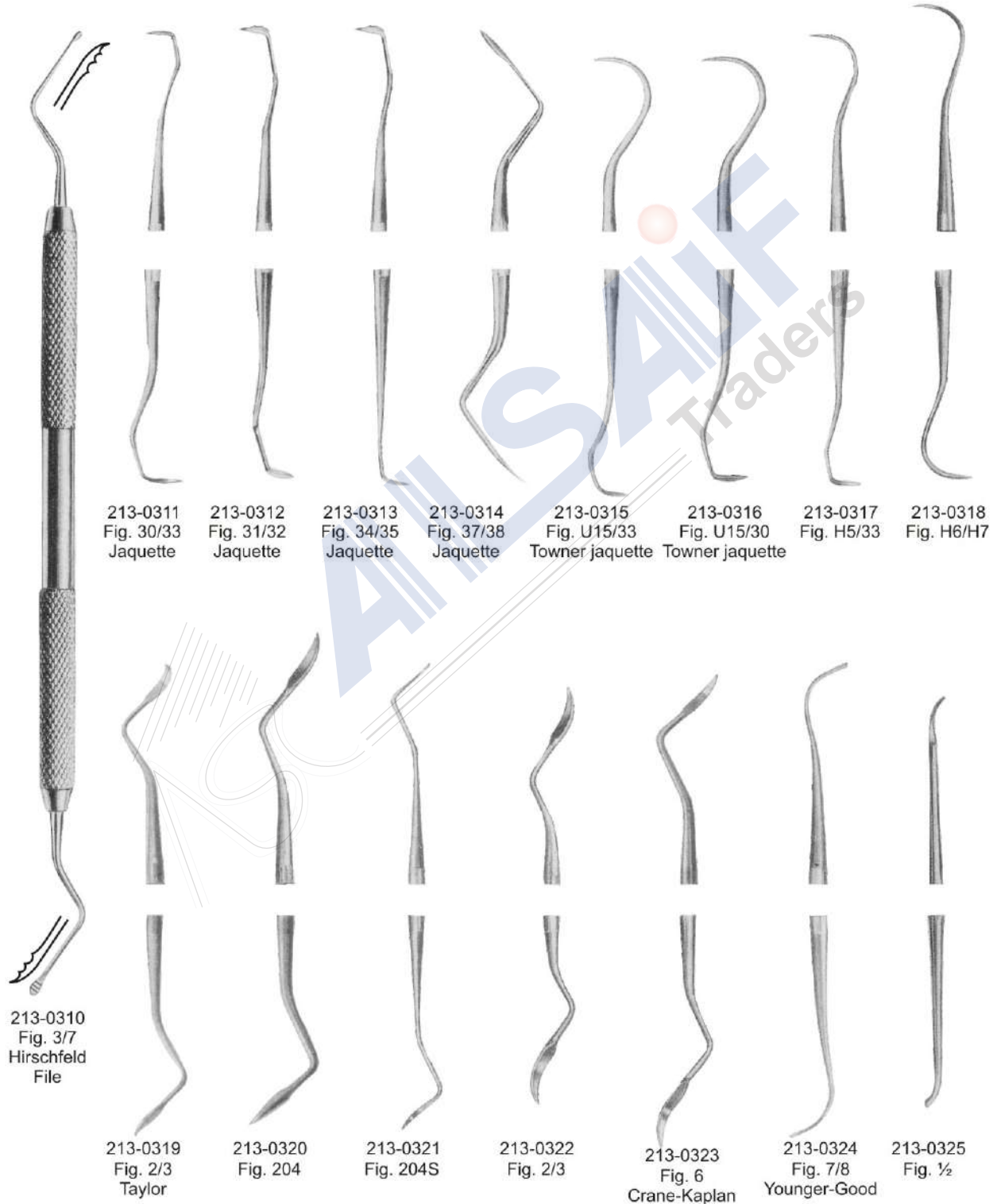

## ●●● PERIODONTIA INSTRUMENTS



## MENT SPATULAS



213-0347



213-0348



213-0349

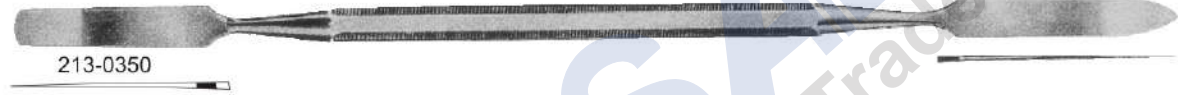

213-0350



213-0351



213-0352

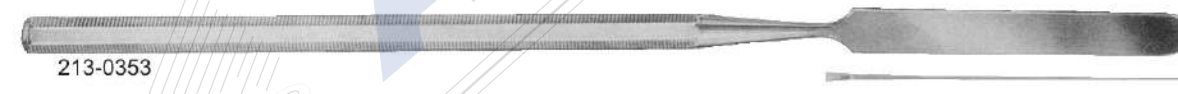

213-0353



213-0354



213-0355  
Fig. 1



213-0356  
Fig. 2



213-0357  
Fig. 3

## ● ● ● WEX AND MODELLING CARVERS



## WEX AND MODELLING CARVERS ●●●



## ●●● WEX AND MODELLING CARVERS



213-0374  
Fig. 1  
P. K.thomas



213-0375  
Fig. 2  
P. K.thomas

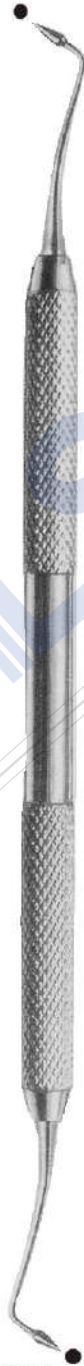

213-0376  
Fig. 3  
P. K.thomas



213-0377  
Fig. 4  
P. K.thomas



213-0378  
Fig. 5  
P. K.thomas





## ●●● SPATULAS FOR PLASTER AND ALGINATE

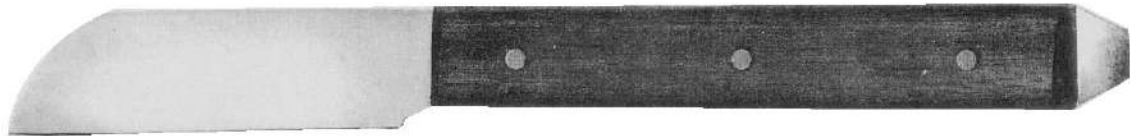

214-0007  
cm 17

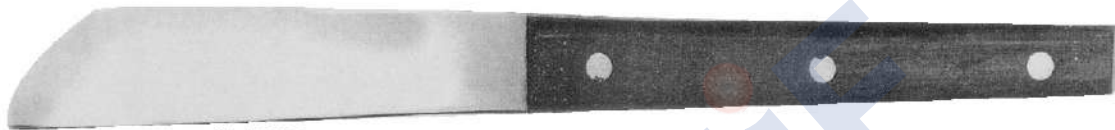

214-0008  
cm 17 Gritman



214-0009  
cm 19.5

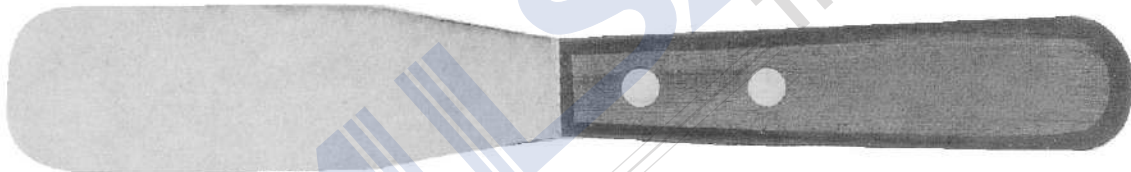

214-0010  
cm 21.5

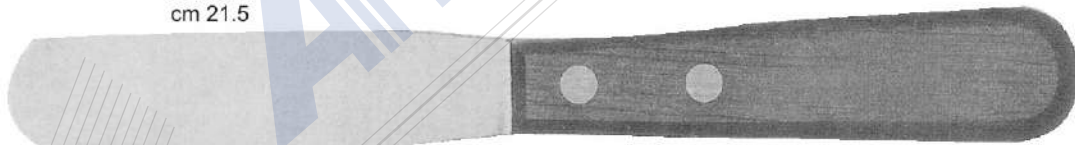

214-0011  
cm 20.5

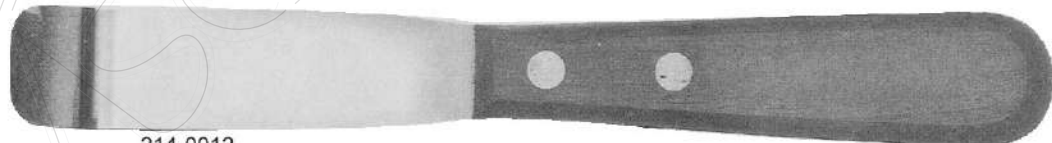

214-0012  
cm 19.5

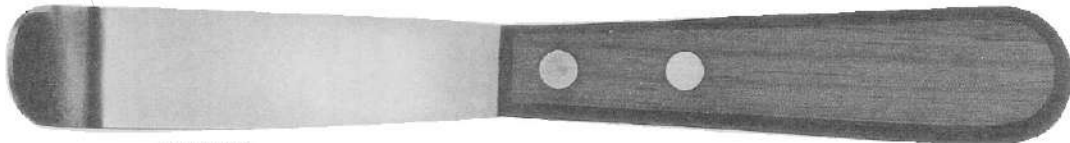

214-0013  
cm 20

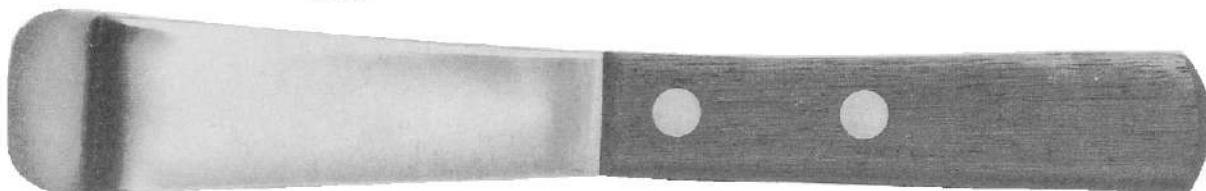

214-0014  
cm 22.5

## AMALGAM CARRIERS ● ● ●



## ●●● DENTAL CARTRIDGE SYRINGES



215-0012



215-0013



215-0014



215-0015



215-0016



215-0017



215-0018



215-0019



215-0020



215-0021

## DENTAL CARTRIDGE SYRINGES ●●●



215-0022



215-0023



215-0024

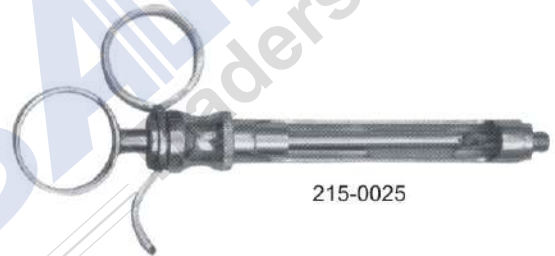

215-0025



215-0026



215-0027



215-0028



215-0029



215-0030



215-0031

## ● ● ● CHIP BLOWERS, WATER SYRINGES



Chip blower

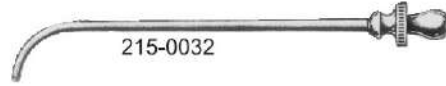

215-0032



215-0033

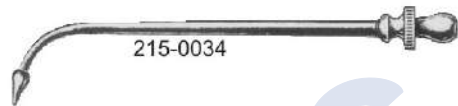

215-0034



Films Holder

- 215-0035 For 6 Films
- 215-0036 For 10 Films
- 215-0037 For 14 Films

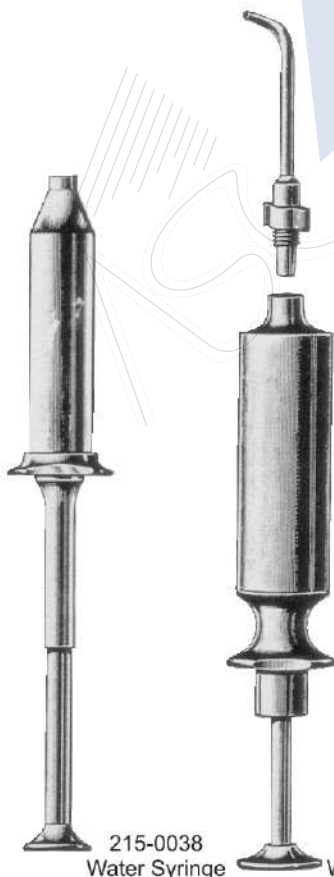

215-0038  
Water Syringe

215-0039  
Water Syringe

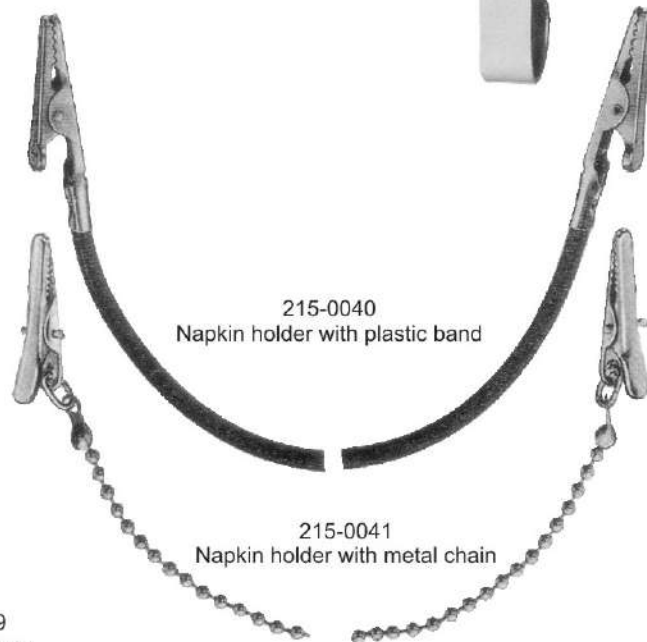

215-0040  
Napkin holder with plastic band

215-0041  
Napkin holder with metal chain

## MATRIX RETAINERS ●●●



215-0042-5mm  
 215-0043-6mm  
 215-0044-7mm  
 Ivory

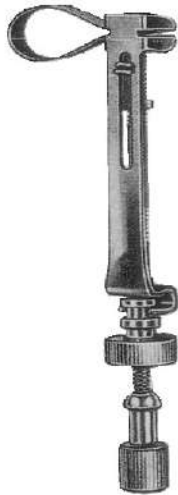

215-0045  
 Ivory 8 N



215-0046  
 Ivory 8



215-0047  
 Siqveland-narrow  
 215-0048  
 Siqveland-wide



215-0049  
 Fig. 1  
 Toffemire-universal

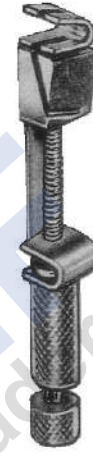

215-0050  
 Fig. 2  
 Toffemire-senior



215-0051  
 Fig. 3  
 Toffemire-junior



215-0052  
 Fig. 2  
 Didher 8



215-0053  
 Ivory



215-0054  
 Ivory



215-0055  
 Ivory separator

## ●●● CROWN INSTRUMENTS

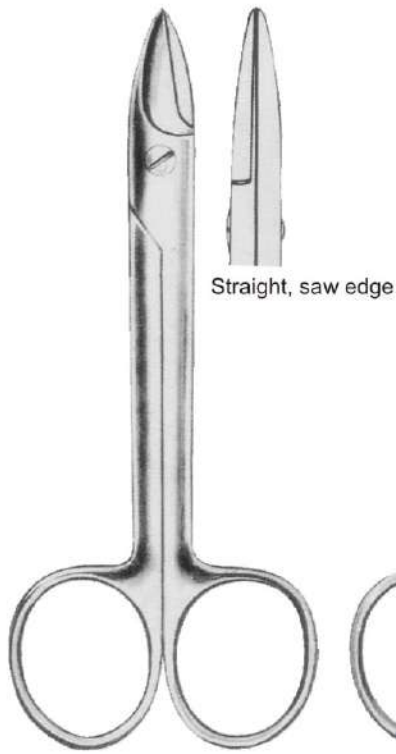

215-0056  
Fig.1  
10.5cm

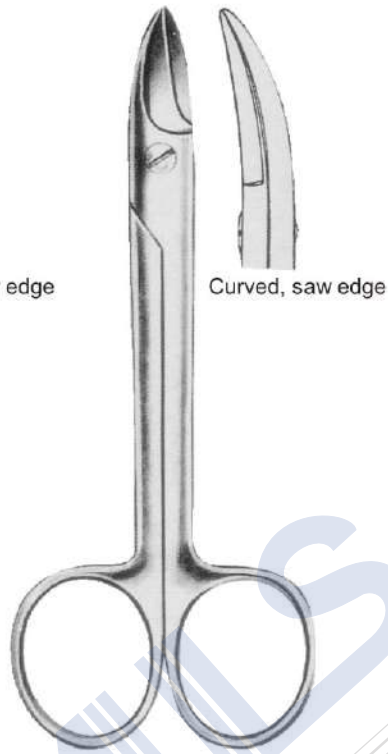

215-0057  
Fig.2  
10.5cm

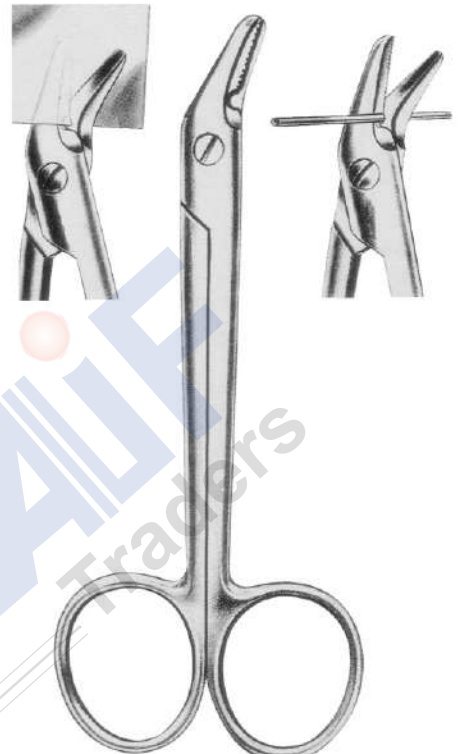

215-0058  
Universal  
12cm

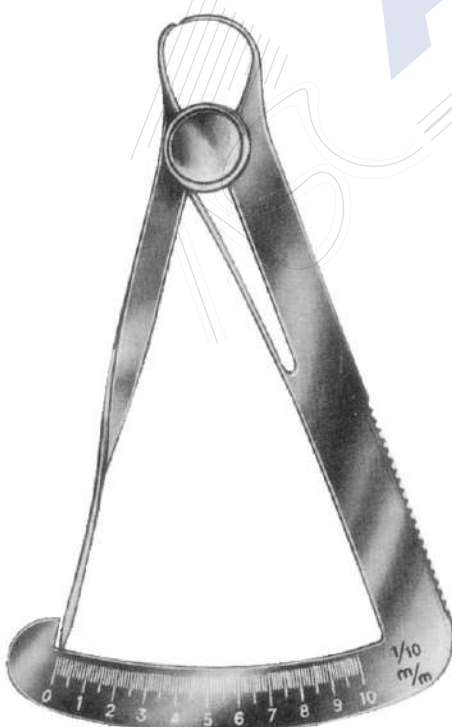

215-0059  
Lwanson



215-0060  
Fig.3  
Crown spreaders



215-0061  
Boley  
14cm



## CROWN REMOVERS ●●●

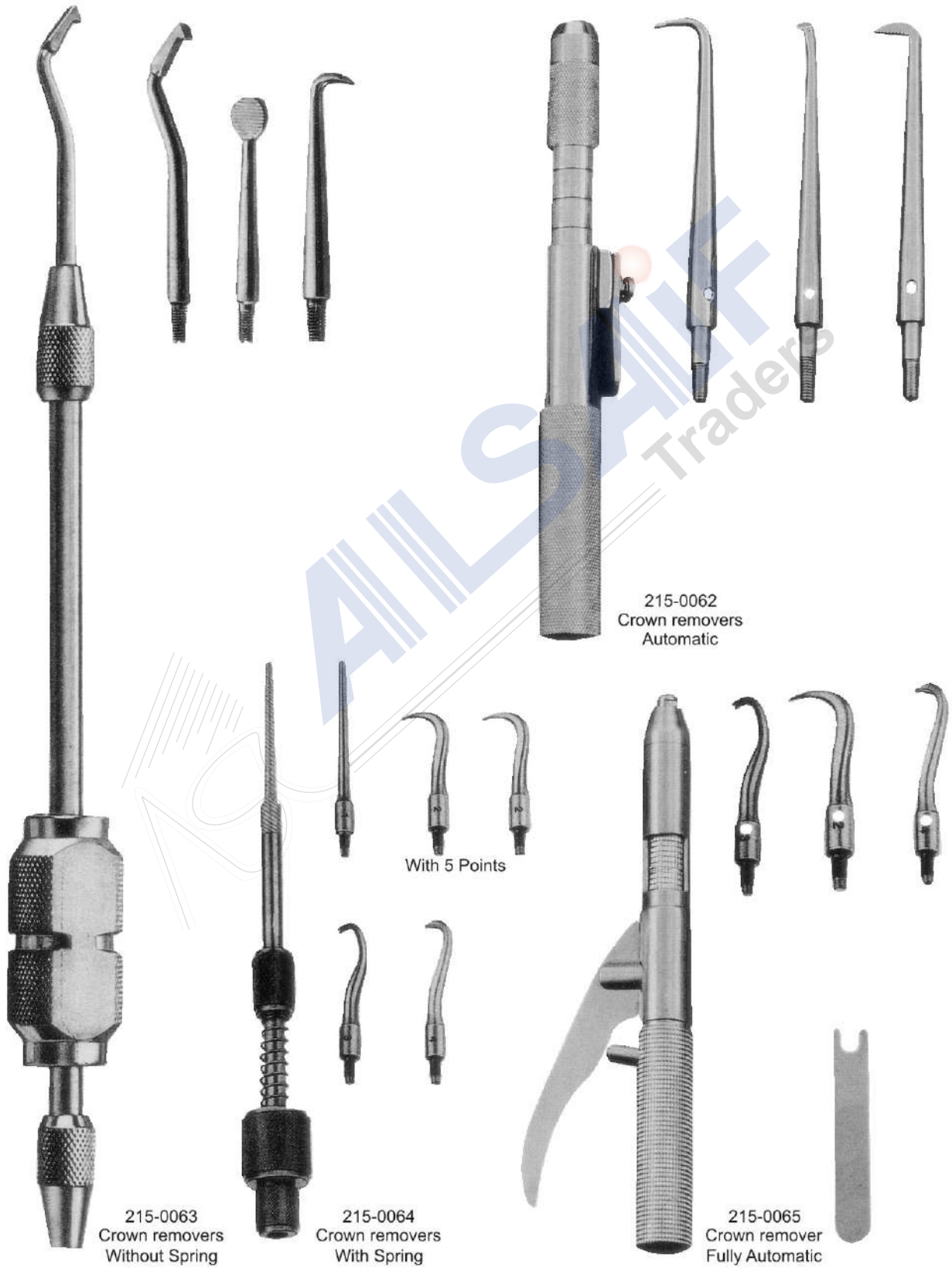

## ●●● CROWN INSTRUMENTS



215-0066  
Articulating Paper Forcep  
15cm



215-0067  
Miller  
15cm

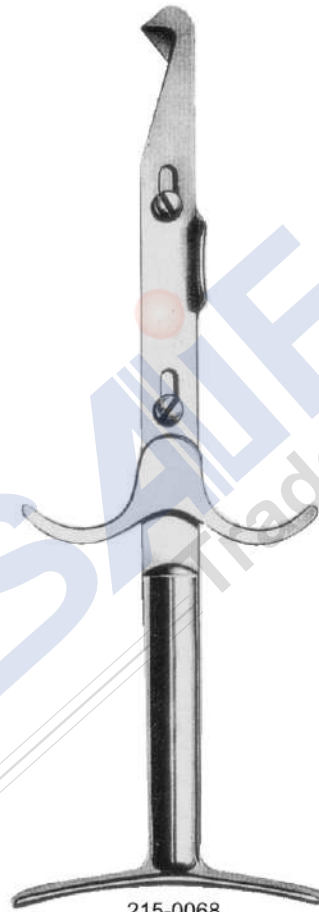

215-0068  
Crown Spreader



215-0069  
Vernier Gauge Caliper  
0mm to 80mm

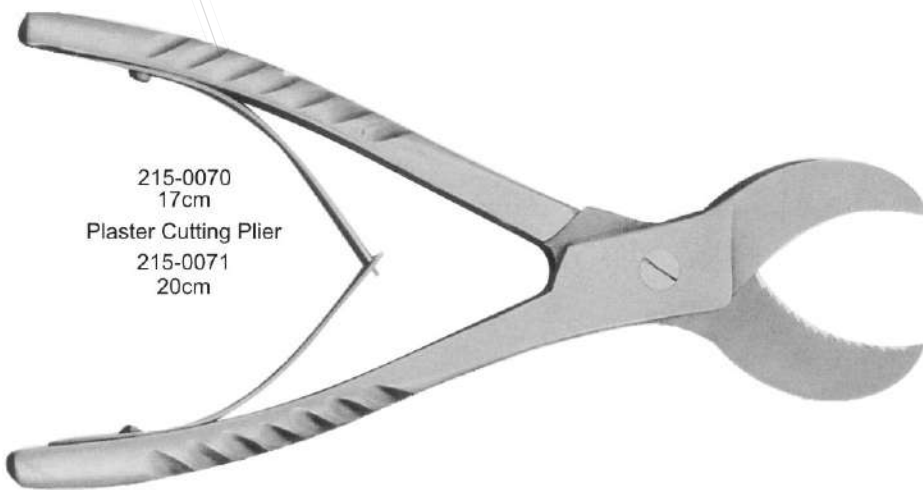

215-0070  
17cm  
Plaster Cutting Plier  
215-0071  
20cm



215-0072  
Arch Turret with 5 wire-slots  
.016", .017", .018", .020" and .022"

**Available in Set of 8**  
**Code # Set - A001**

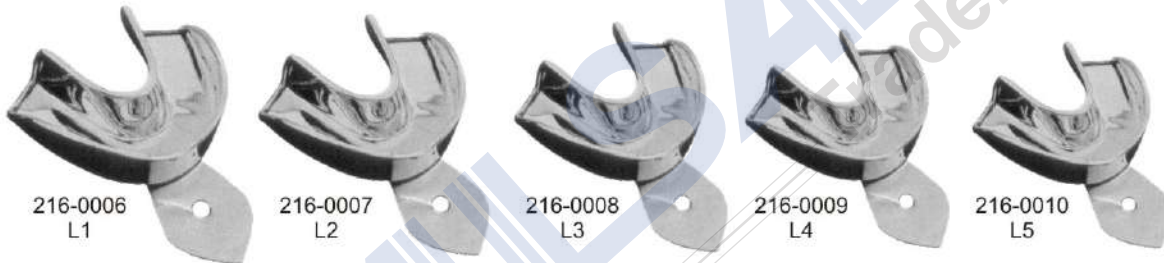
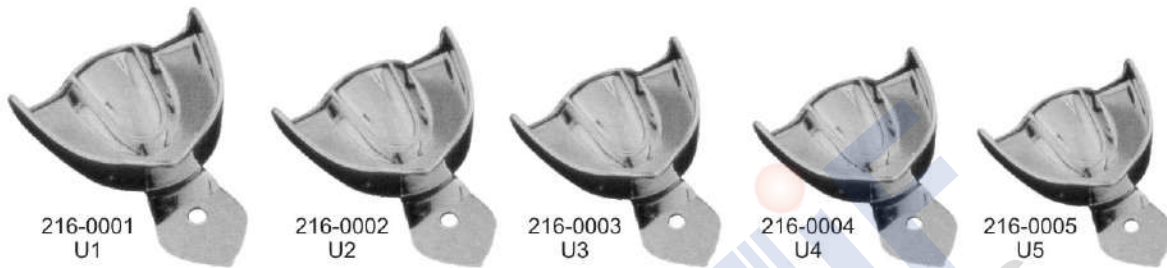

All the above impression trays are available in these 4 sizes

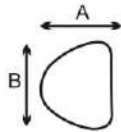

UPPER		U1	U2	U3	U4	U5
	A		62	60	53	54
B		63	75	73	69	68

All Dimension are in mm

Lower		L1	L2	L3	L4	L5
	A		63	61	57	60
B		82	81	78	74	71

All Dimension are in mm

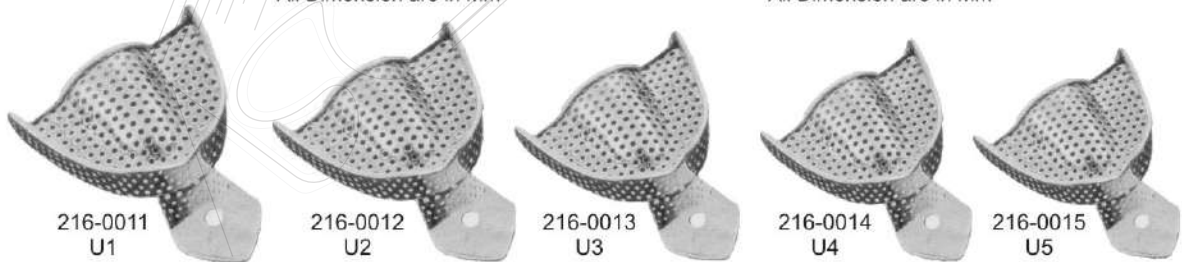
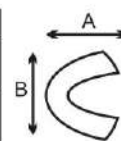

**Available in Set of 8**  
**Code # Set - A002**

## ●●● IMPRESSION TRAYS

**Available in Set of 8**  
**Code # Set - A003**

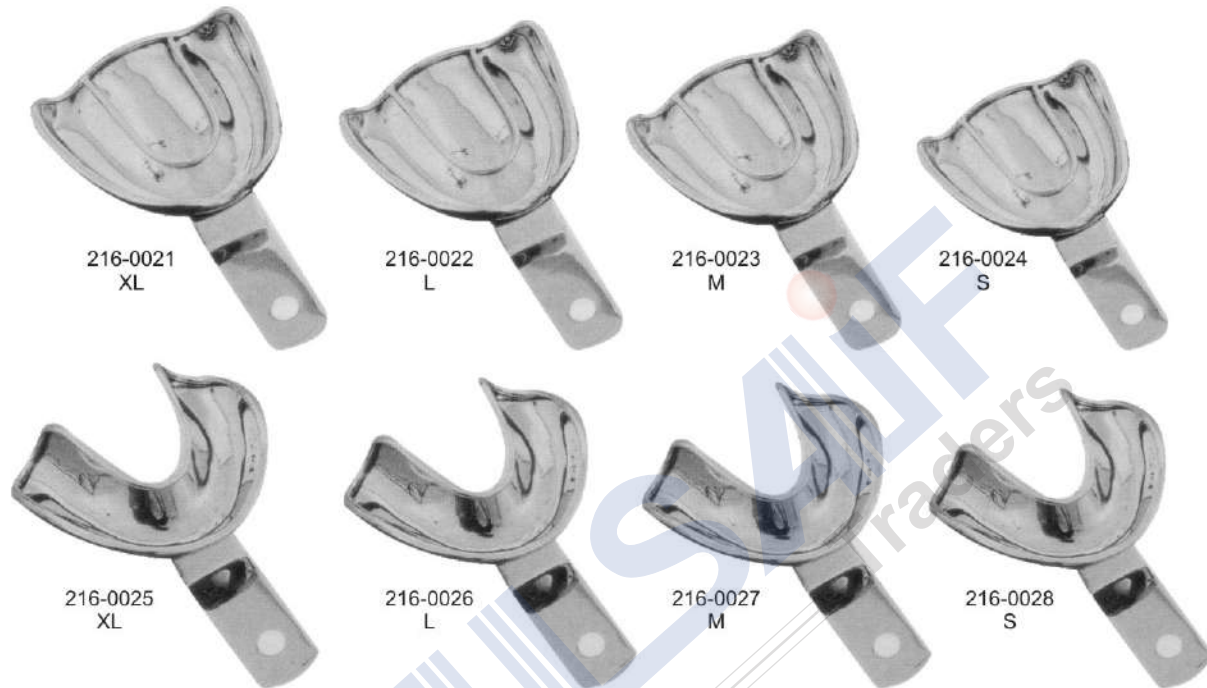

All the above impression trays are available in these 4 sizes

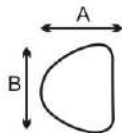

UPPER		XL	L	M	S
	A	70	67	64	60
B	79	78	70	73	

All Dimension are in mm

LOWER		XL	L	M	S
	A	64	64	60	57
B	86	70	73	70	

All Dimension are in mm

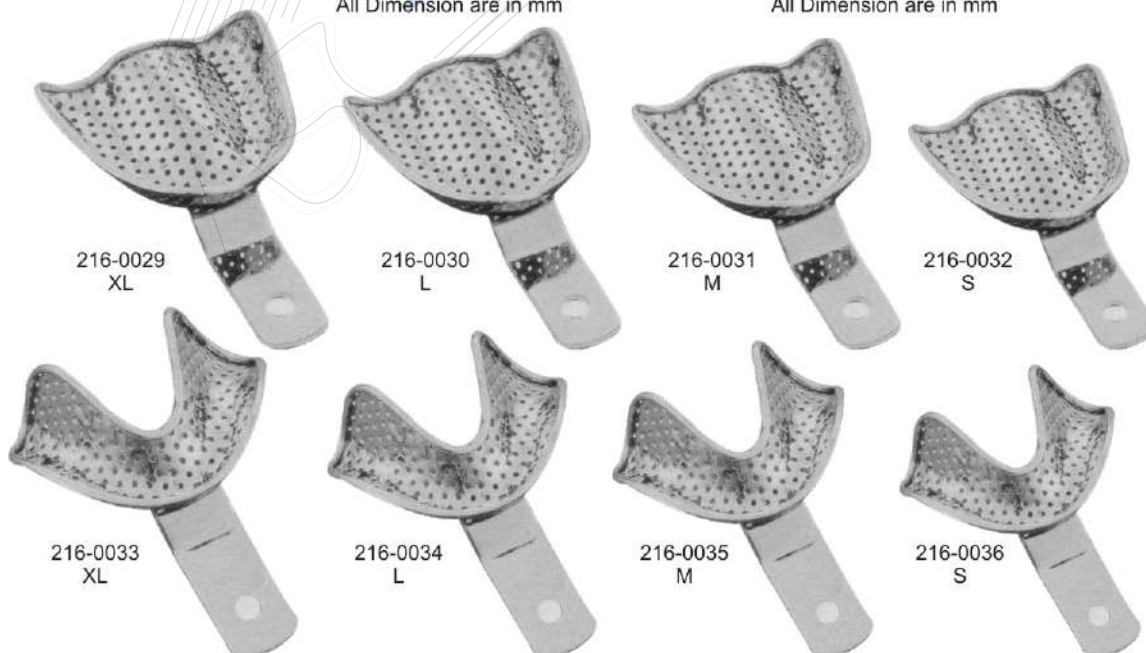
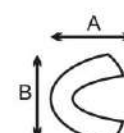

**Available in Set of 8**  
**Code # Set - A004**

## IMPRESSION TRAYS ●●●

**Available in Set of 6**  
**Code # Set - A005**



216-0037  
U1



216-0038  
U2



216-0039  
U3



216-0040  
L1

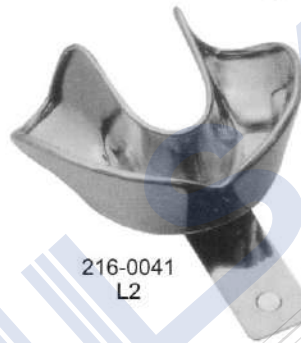

216-0041  
L2

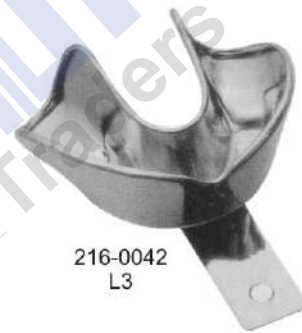

216-0042  
L3

All the above impression trays are available in these 4 sizes

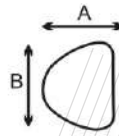

LOWER	All Dimension are in mm		
	L1	L2	L3
A	67	64	57
B	81	71	70

All Dimension are in mm

LOWER	All Dimension are in mm		
	L1	L2	L3
A	60	57	64
B	84	79	76

All Dimension are in mm

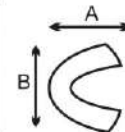

216-0043  
U1



216-0044  
U2



216-0045  
U3



216-0046  
L1



216-0047  
L2



216-0048  
L3

**Available in Set of 6**  
**Code # Set - A006**

## ●●● IMPRESSION TRAYS

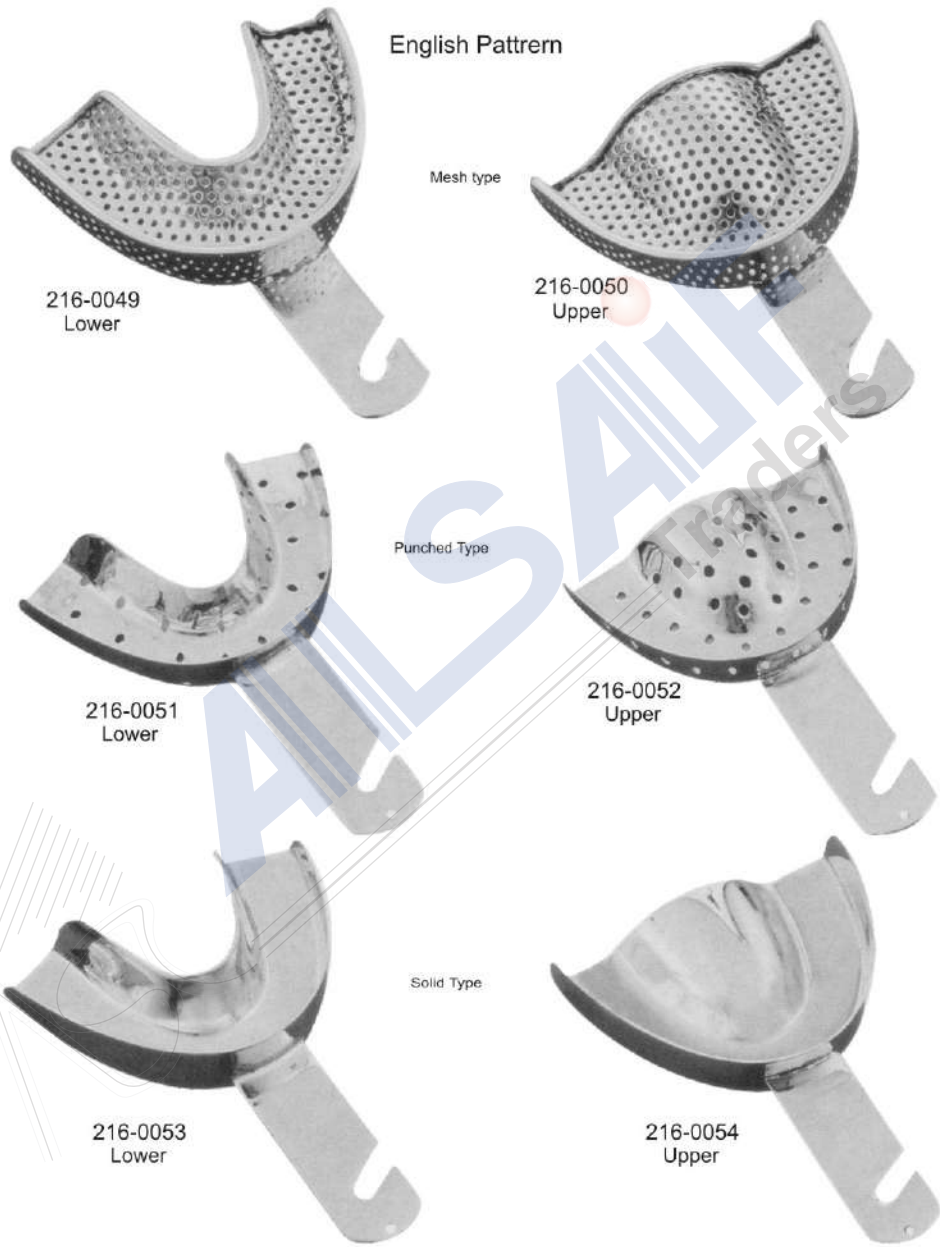

All the above impression trays are available in these 4 sizes

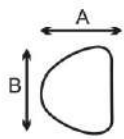

UPPER	Size	A	B	C
	0	67	50	12
	1	72	51	13
	2	78	55	15
	3	80	58	15

All Dimension are in mm

LOWER	Size	A	B	C
	0	70	50	12
	1	77	51	13
	2	77	55	15
	3	80	50	15

All Dimension are in mm

## IMPRESSION TRAYS ●●●

**Available in Set of 8**  
**Code # Set - A007**



All the above impression trays are available in these 4 sizes

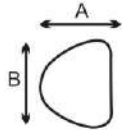

UPPER		XL	L	M	S
	A		70	67	64
B		79	78	70	73

All Dimension are in mm

LOWER		XL	L	M	S
	A		64	64	60
B		86	70	73	70

All Dimension are in mm

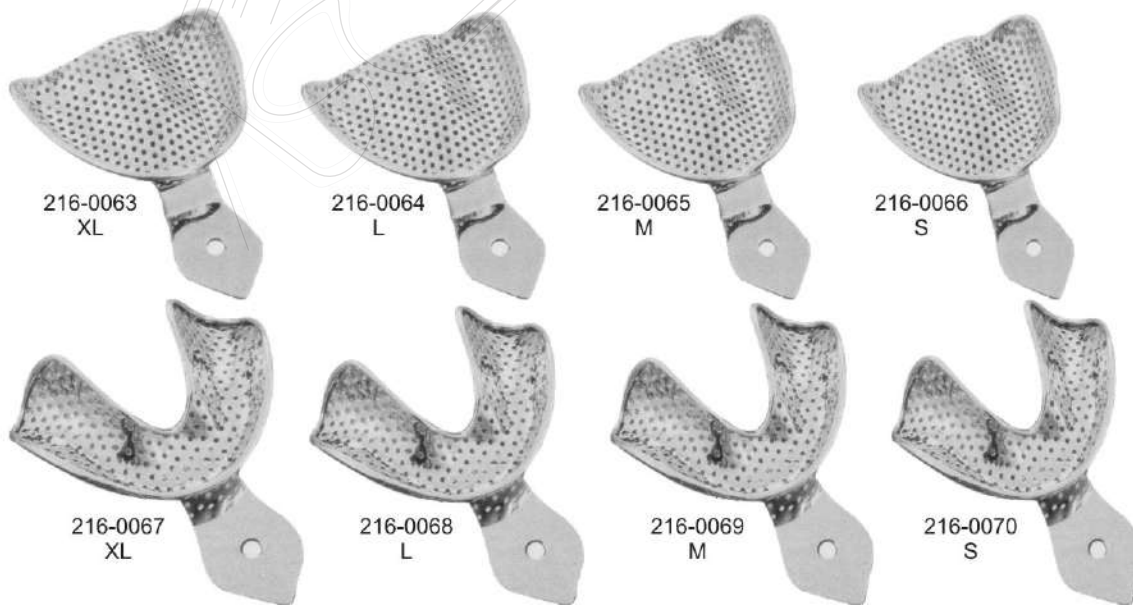
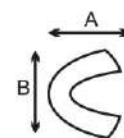

**Available in Set of 8**  
**Code # Set - A008**

## ●●● IMPRESSION TRAYS

**Available in Set of 8**  
**Code # Set - A009**

For crown & bridgework Impression Trays

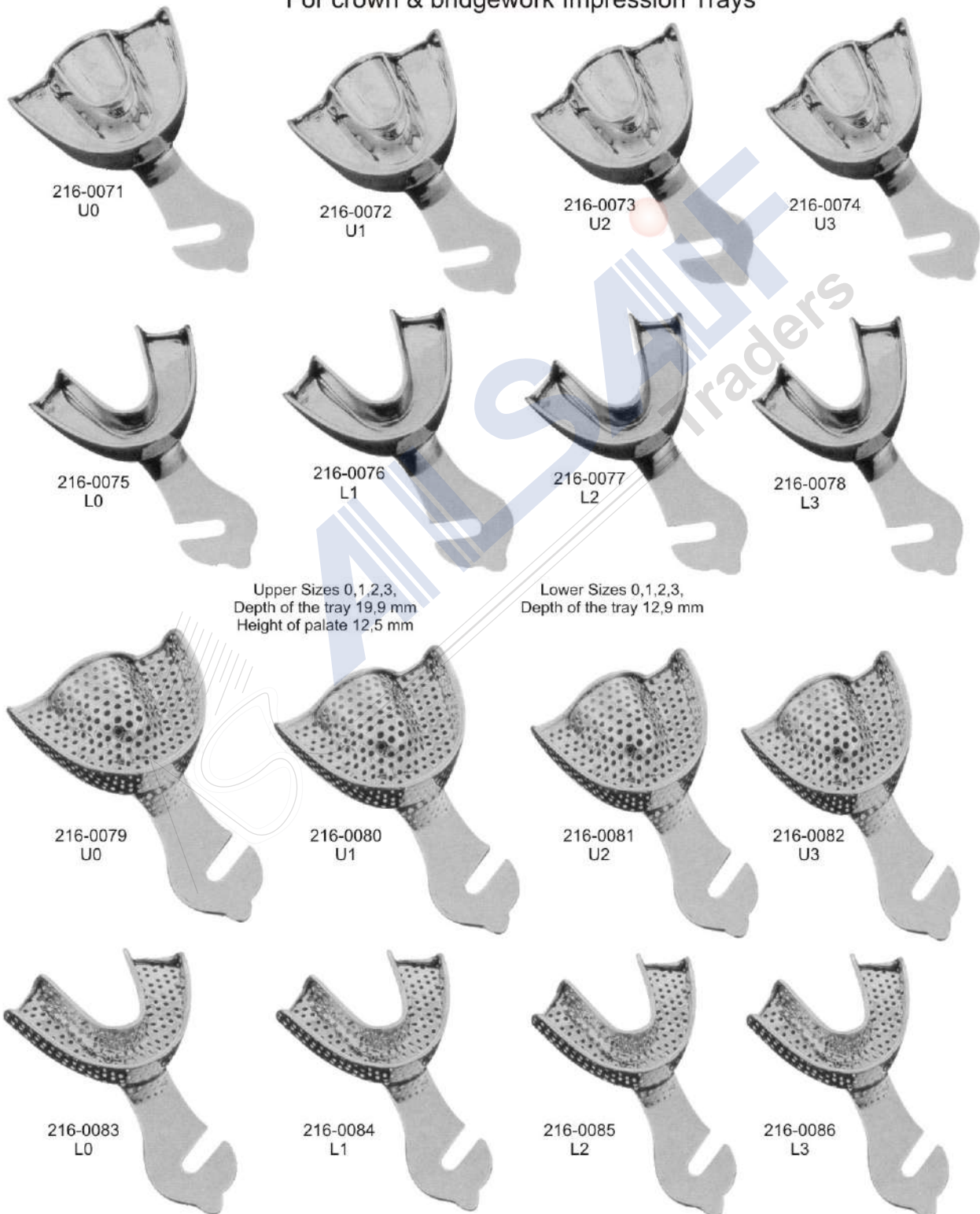

**Available in Set of 8**  
**Code # Set - A010**



## IMPRESSION TRAYS ●●●

Impression trays for crown & bridge work



216-0087  
U1P



Solid

216-0088  
L1P



216-0089  
U1P

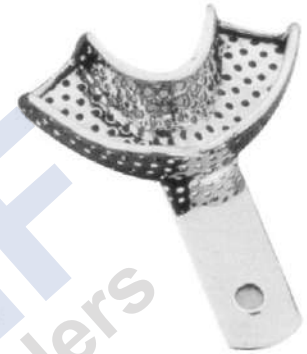

Perforated

216-0090  
L1P

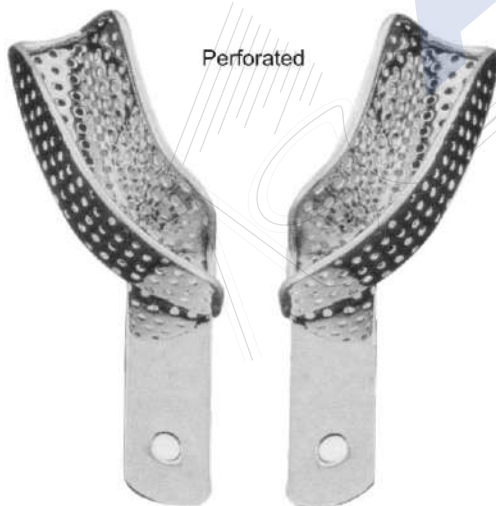

Perforated

216-0091  
For upper right jaw  
For lower left jaw

216-0092  
For upper left jaw  
For lower right jaw



216-0093  
Adjustable  
Perforated



216-0094  
Adjustable  
Solid

Available in 4 Sizes

- 1.....44 mm
- 2.....55 mm
- 3.....60 mm
- 4.....65 mm

Also available in Solid pattern

## ●●● INSTRUMENTS TRAYS

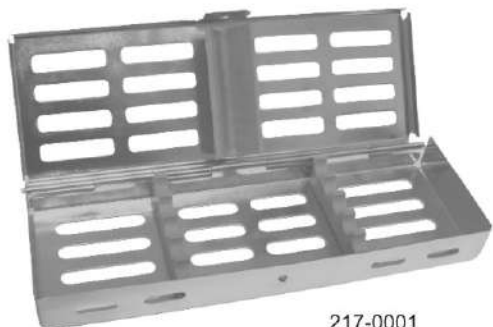

217-0001  
Scalor Sterilizing Tray  
For 5-pcs  
18 x 6 x 2 cm



217-0002  
Scalor Sterilizing Tray  
For 5-pcs  
18 x 8.5 x 2 cm

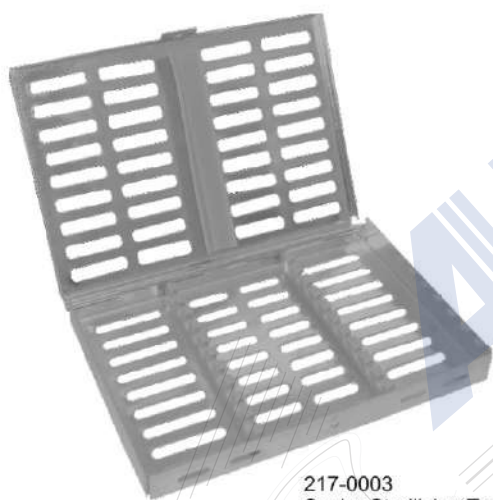

217-0003  
Scalor Sterilizing Tray  
For 10-pcs  
18 x 12.5 x 2 cm

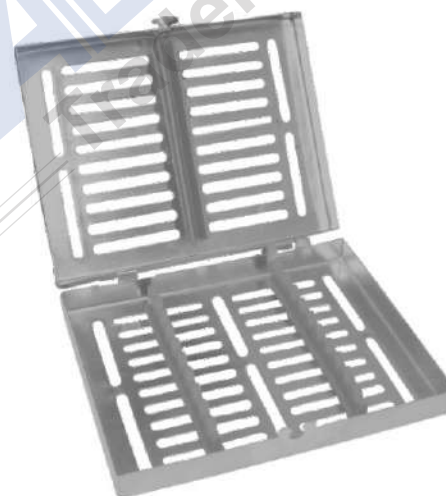

217-0004  
Scalor Sterilizing Tray  
For 10-pcs  
18 x 14 x 2 cm

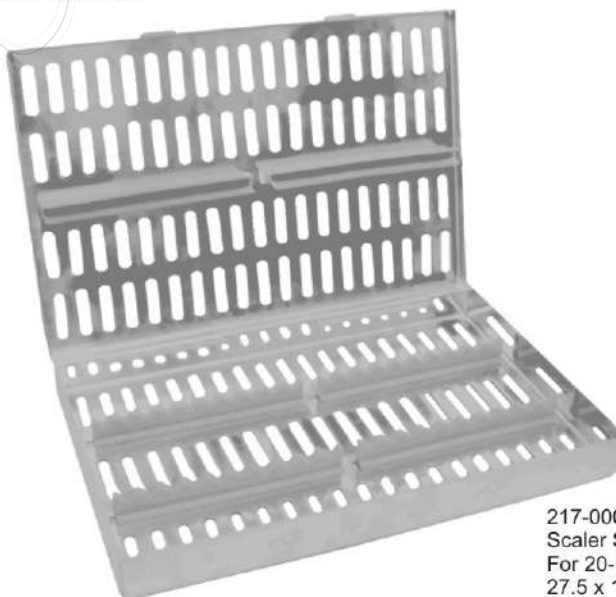

217-0005  
Scalor Sterilizing Tray  
For 20-pcs  
27.5 x 18 x 2.5 cm

## HOLLOW WARE ITEMS ● ● ●



217-0006  
Scallers Tray

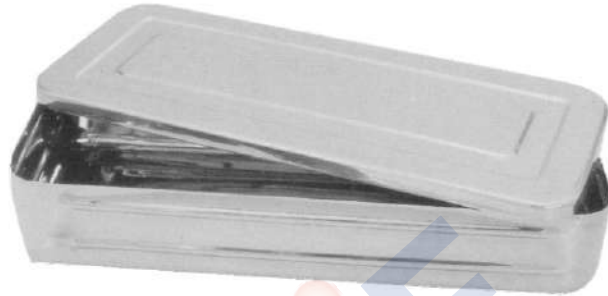

Instruments Box

217-0007  
 10"×6"×2"  
 217-0008  
 12"×8"×2½"  
 217-0009  
 16"×12"×4"

217-0010  
 8"×6"×2"  
 217-0011  
 10"×8"×2"  
 217-0012  
 12"×8"×2½"  
 217-0013  
 12"×10"×2½"  
 217-0014  
 14"×10"×2½"  
 217-0015  
 14"×12"×2½"



Instruments Tray with Lid

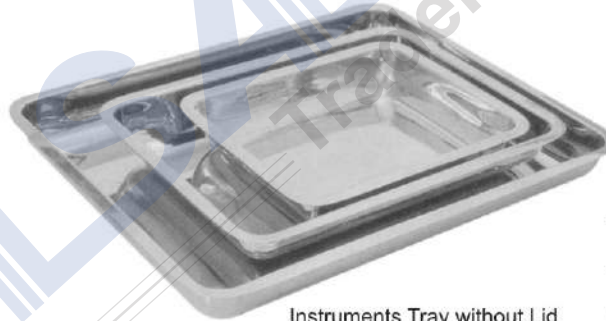

Instruments Tray without Lid

217-0016  
 8"×6"×2"  
 217-0017  
 10"×8"×2"  
 217-0018  
 12"×8"×2½"  
 217-0019  
 12"×10"×2½"  
 217-0020  
 14"×10"×2½"  
 217-0021  
 14"×12"×2½"

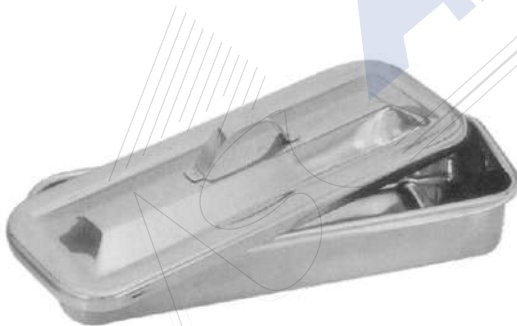

217-0022  
8"×3"×1½"  
Instruments Box

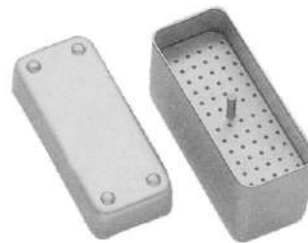

217-0023  
Endodontic box

217-0024  
 10"×6"×2"  
 217-0025  
 12"×8"×2½"  
 217-0026  
 16"×12"×4"

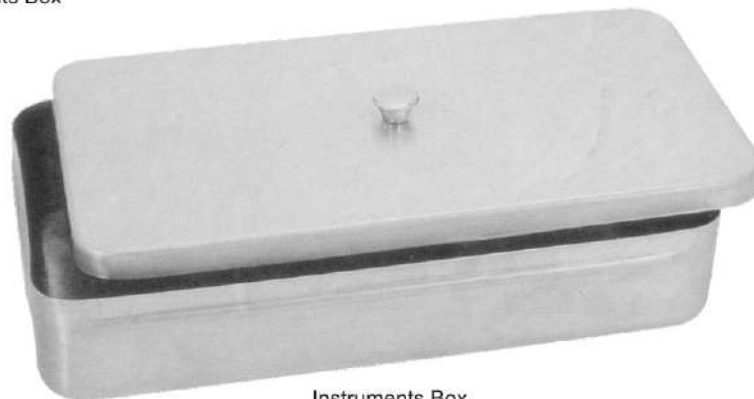

Instruments Box

## ●●● HOLLOW WARE ITEMS

	Ø	Depth
217-0027	2"	2"
217-0028	4"	2"
217-0029	5½"	2½"
217-0030	6"	2¾"
217-0031	7"	3½"
217-0032	8"	3½"
217-0033	10"	4"



Lotion Bowl



Kidney Trays

217-0034	6"
217-0035	8"
217-0036	10"
217-0037	12"



217-0038  
6" x 9"  
Sterilizing Drum  
217-0039  
8" x 12"



217-0040  
10" x 10"  
Sterilizing Drum



217-0041  
Cotton Holder



217-0042  
80 x 35 mm  
Medicine Cup  
217-0043  
125 x 60 mm

217-0046	25 x 80 mm
217-0047	30 x 100 mm
217-0048	75 x 173 mm
217-0049	100 x 200 mm



217-0044  
Spirit Lamp



217-0045  
Spirit Lamp

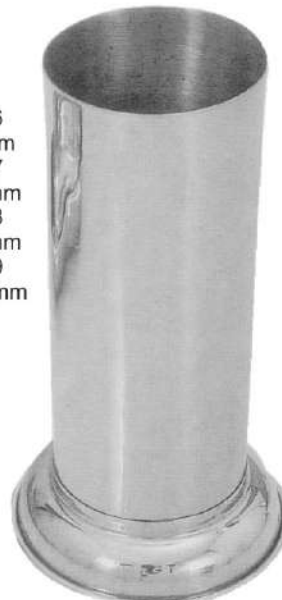

Forcep Jar



217-0050  
5cm x 15cm  
Forcep Jar  
217-0051  
5cm x 10cm

## RUBBER DAM CLAMPS ●●●

### Molar Clamps Winged



218-0001  
Fig. 30



218-0002  
Fig. 31



218-0003  
Fig. 51



218-0004  
Fig. 138



218-0005  
Fig. 139



218-0006  
Fig. 15



218-0007  
Fig. 18



218-0008  
Fig. 24



218-0009  
Fig. 25



218-0010  
Fig. 26



218-0011  
Fig. 28

### Bicuspid Clamps Winged



218-0012  
Fig. 206



218-0013  
Fig. 207



218-0014  
Fig. 208



218-0015  
Fig. 209



218-0016  
Fig. 22



218-0017  
Fig. 27



218-0018  
Fig. 29

### Molar Clamps Winged



218-0019  
Fig. 26A



218-0020  
Fig. 28A



218-0021  
Fig. 30A



218-0022  
Fig. 31A



218-0023  
Fig. 51A

### Bicuspid Clamps Winged



218-0024  
Fig. 27



218-0025  
Fig. 29



218-0026  
Fig. 60

### Molar Clamps Winged



218-0027  
Fig. 200



218-0028  
Fig. 201



218-0029  
Fig. 202



218-0030  
Fig. 203



218-0031  
Fig. 204



218-0032  
Fig. 205

### Labial Clamps Winged



218-0033  
Fig. 210



218-0034  
Fig. 211



218-0035  
Fig. 212

## ●●● ARTICULATOR



219-0001



219-0002



219-0003



219-0004



219-0005



219-0006

## IMPRESSION TRAYS SETS ●●●



220-0001



220-0002



220-0003

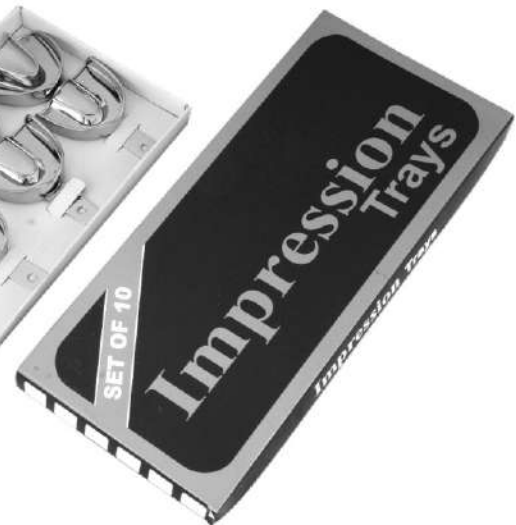

## ● ● ● IMPRESSION TRAYS SET



220-0004

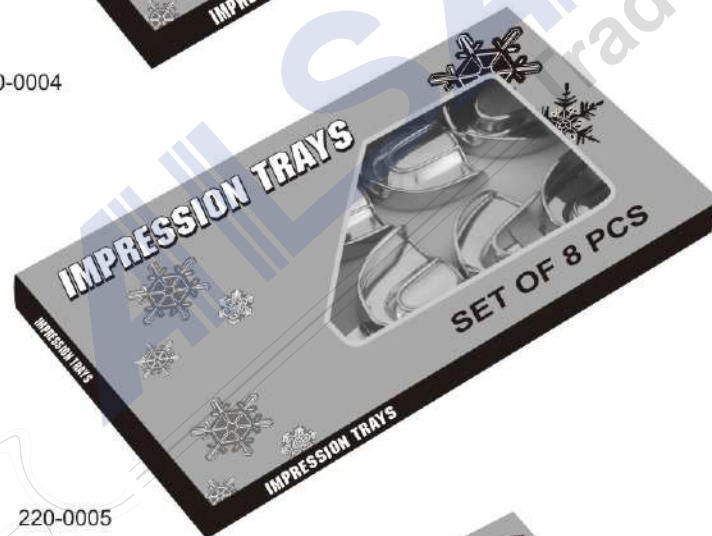

220-0005



220-0006





220-0007



220-0008



220-0009



220-0010



220-0011



220-0012



220-0013



220-0014



220-0015

## ●●● INSTRUMENTS PACKINGS



220-0016



220-0017



220-0018



220-0019



220-0020



220-0021



220-0022



220-0023

**A**

Aspirating Syringe	95
Arruga Needle Holder	48
Apexo Root Elevator	21,22,23
Angle Pliers	30
Amalgam Carriers	94
Amalgam Well	94
Alm Retractors	53
Adson Forceps	59
Aderer Pliers	28,31,32
Adams Pliers	31,35
Arch Forming Plier	32,34
Angle Bending Pliers	33
Arch Torquing & Bending Pliers	37
Arch Turret	100

**B**

Bone Rongeurs	20
Bone Files	79,80
Bone Curettes	81
Boley Gauge	98
Bein Elevator	21,26
Bending plier for lingual cleat	32
Bracket Removing Pliers	33,37
Band Removing Pliers	34,37
Bending Pliers	30,32,35
Barry Elevators	27
Band Pusher	38
Bracket Tweezer	39

**C**

Cryer Elevators	24,26
Crown Scissors	98
Crown Removers	99
Crane-kplane	60
Coupland Elevators	25
Cotton & Dressing Pliers	60
Columbia Curettes	83
Chisels	57
Chip Blower	96
Cheatle Forceps	49
Cement Spatulas	88
Castroviejo Scissors	42
Castroviejo Needle Holders	48
Carvers	72,73
Cartridge Syringe	95
Curtis Elevators	22
Crown Spreader	98
Cogswell Elevators	23
Crile Forceps	45
Cotton Holder	110

**D**

Dressing Forceps	46
Distel Cutter	37

**E**

Extracting Forceps (English Pattern)	1,2,3,4,5,6,7,8,9,10,11,12,13
Extracting Forceps (American Pattern)	14,15,16,17,18,19
Explorers	64,65,66
Excavators	75,76,77
Endodontic Box	109

**F**

Farabeuf Retractor	52
Flohr Elevator	21,26
Flagg Forceps	60
Filling Instruments	68,69,70,71
Film Holder	96
Forcep Jar	110
Flat Pliers	29,33,34

**G**

Gum Scissors	40,41
Goldman-Fox Scissors	40,41
Goldman-Fox Scalars	82,85
Goldman-Fox Explorers	66
Graefe Retractor	50
Gracey Curettes	84
Gillies Retractor	50
Gordon - Contouring Plier	35

**H**

How Pliers	29,35
Hollen Back	70,72
Hollow Handle Scaler	74
Heidbrink Elevators	23,27
Handle	63
Handles For Mouth Mirror	61
Hard Wire Cutter	32,37

**I**

Ivory Separator	97
Iris Scissors	40
Intraligamentary Syringe	95
Instruments Trays	109
Impression Trays	101,102,103,104,105,106,107
Instruments Box	109

**J**

Jaquette Curettes	86
Jarabak Pliers	30

**K**

Kelly Scissors	41
Kidney Trays	110

**L**

Lucas Curettes	81
Locklin Scissors	41
Lwanson Gauge	98
Lotion Bowl	110
Ligature Pin Cutter	37

**M**

Mouth Mirror	61
Mosquito Forceps	39,44
Metzenbaum Scissors	43
Meriam Forceps	60
Mc Call Curettes	85
Mayo. Scissors	43
Mayo-Hegar Needle Holder	47
Matrix Retainers	97
Mathieu Needle Holders	48
Mathieu Pliers	39
Miller	100
Mixer Forceps	45
Medicine Cup	110

**N**

Neumann Scissors	42
Needle Holders	47,48
Napkin Holders	96
Nance Pliers	28
Nance Closing Loop Pliers	33

**O**

Orthodontic Instruments	38,39
-------------------------	-------

**P**

Plaster Cutting Pliers	100
Perry Forceps	60
Periodontia Probes	67
Periodontia Inst.	78,82,83,86,87
Peeso Pliers	30
Pean Forceps	44
Preparation Instruments	74

**R**

Rubber Dam Punch	58
Rubber Dam Frame	58
Rubber Dam Clamps	58
Rubber Dam Clamps	111
Retractors	50,51,52,53
Raspatories	56

**S**

Sterilizing Drum	110
Splinter Forceps	19
Spirit Lamp	110
Spencers Scissors	42
Spatulas For Plasters	93
Semken-Taylor Forceps	59
Seldin Elevators	21,22,23
Scaler Sterilizing Tray	108
Skin Hook	50
Separating Pliers	38
Stout Elevators	22
Scalpel Handles	62

**T**

Tweed Pliers	31
Towel Clamps	49
Tofflemire	97
Tissue Pliers	59

**U**

Universal Pliers	28
Universal Facebow Pliers	36
Universal Scissors	98

**V**

Vernier Gauge Caliper	100
-----------------------	-----

**W**

Woodson	72
Wire Bending Pliers	31
Williger Elevators	54,55
Westcott Scissors	42
Wax Knife	92
Wax Carver	89,90,91
Water Syringe	96
Warwick James Elevator	27
Ward Carver	72
Waldsachs Pliers	28
Winter Elevators	27
Weingart Pliers	36

**Y**

Young Pliers	31
--------------	----

*High Quality  
Instruments*

Extraction Sets  
Extracting Forceps  
Root Elevators  
Bone Rongeurs  
Orthodontic Pliers  
Scalers  
Impression Trays

 **A I L S A I F**  
Traders  
Manufacturer & Exporters of Surgical Instruments

**DENTAL**  
*INSTRUMENTS*

